

Stormwater Management Guidelines for the Bay of Plenty region



Bay of Plenty Regional Council
Guideline 2012/01

5 Quay Street
PO Box 364
Whakatāne 3158
NEW ZEALAND

ISSN: 1179-9595 (Print)
ISSN: 1179-9609 (Online)





Stormwater Management Guidelines for the Bay of Plenty region

Guideline 2012/01

April 2012 (updated as at December 2015)

Bay of Plenty Regional Council
5 Quay Street
PO Box 364
Whakatāne 3158
NEW ZEALAND

Guideline prepared by Earl Shaver, Aqua Terra International Ltd



Contents

Part 1: Introduction	1
1.1 Objectives of these guidelines	1
1.2 What is the effect of impervious area on stormwater run-off?	1
1.3 Managing stormwater	2
1.4 Regulatory framework	2
1.5 Technical objectives	3
1.6 Statement of intent	5
Part 2: Effects of land use on stormwater run-off	7
2.1 Urbanisation	7
2.2 Key effects	9
2.3 Water quantity	9
2.4 Water quality	12
2.5 Aquatic habitat	16
2.6 Bibliography	18
Part 3: Receiving environments	21
3.1 Streams and rivers	21
3.2 Ground	23
3.3 Estuaries	25
3.4 Harbours	26
3.5 Open coasts	27
3.6 Lakes	27
3.7 Overall discussion of stormwater and receiving environments	29
3.8 Bibliography	29
Part 4: Site resources	31
4.1 Introduction	31

4.2	Terrestrial ecology and landscape form	31
4.3	Wetlands	35
4.4	Floodplains	37
4.5	Riparian buffers	39
4.6	Vegetation cover	42
4.7	Soils	43
4.8	Slopes/topography	45
4.9	Other natural features	45
4.10	Linkage with site development	47
4.11	Natural mechanisms for stormwater pollution removal	48
4.12	Bibliography	49
Part 5: Stormwater management concepts		51
5.1	Background	51
5.2	Stormwater treatment processes	52
5.3	Bibliography	60
Part 6: Choosing a stormwater management device		61
6.1	Introduction	61
6.2	Site considerations	61
6.3	High groundwater table and potential mounding	65
6.4	High sediment inputs	67
6.5	Contaminant generation	70
6.6	Contaminant removal processes	71
6.7	Device selection	73
6.8	Treatment train approach	74
6.9	Bibliography	75
Part 7: Hydrology and water quality		77
7.1	Water quantity design	77

7.2	Stream channel erosion	85
7.3	Water quality design	90
7.4	Summation of recommendations	93
7.5	Bibliography	95
Part 8: Design procedures for incorporation of LID into site design		97
8.1	Introduction	97
8.2	Design procedure in overview	97
8.3	LID design approach	99
8.4	How to measure success	105
8.5	Other types of development	106
8.6	Case studies	107
8.7	Bibliography	111
Part 9: Detailed stormwater management practice design		113
9.1	Introduction	113
9.2	Source control	113
9.3	Design for operation and maintenance	113
9.4	Consideration of practices in series	115
9.5	Flow and treatment control	116
9.6	Bibliography	211
Part 10: Innovative practices		213
10.1	Introduction	213
10.2	Objective	213
10.3	General information required from an applicant for approval of innovative systems	214
10.4	Information needed to judge adequacy of existing or proposed monitoring data	215
10.5	Discussion	217

Part 11: Landscaping	219
11.1 Introduction	219
11.2 Objective	219
11.3 Use of native species	221
11.4 General landscape guidance for all stormwater practices	221
11.5 Specific landscape provisions for individual stormwater management practices	224
11.6 Bibliography	227
Part 12: Outlet design	229
12.1 Introduction	229
12.2 Objective	230
12.3 Design approach	230
12.4 Detailed design	234
12.5 Construction	235
12.6 Operation and maintenance	236
12.7 Bibliography	236
Part 13: Retrofitting problem areas	237
13.1 Introduction	237
13.2 Prioritisation of projects	237
13.3 Overall retrofitting selection process	239
13.4 Space availability	244
13.5 Ability to get run-off to the practice	244
13.6 Magnitude of benefit	244
13.7 Cost	245
13.8 Maintenance access	246
13.9 Taking advantage of opportunities	246
13.10 Bibliography	249

Part 14: Catchment wide considerations incorporating LID	251
14.1 Introduction	251
14.2 Catchment checklist	251
14.3 Case studies	252
14.4 Bibliography	261

Part 1: Introduction

1.1 Objectives of these guidelines

The primary objective of these guidelines is to provide a design guideline for the Bay of Plenty region for stormwater management. Specifically this includes design guidance for stormwater quality treatment and stormwater quantity control. Practices that will be discussed include ponds, wetlands, filtration practices, infiltration practices, biofiltration practices and other practices that may be used.

The guidelines also have the following secondary objectives:

- 1 To provide the reader with a summary of the principles of stormwater management including an outline of environmental effects and management concepts;
- 2 To outline the statutory process and provide context for the guideline in relation to stormwater discharges;
- 3 To provide a resource guideline for those involved with the design of stormwater management practices; and
- 4 To minimise adverse environmental effects of stormwater discharges through appropriate site design and design of stormwater management practices.

1.2 What is the effect of impervious area on stormwater run-off?

Urban and rural land use within the Bay of Plenty region has changed the character of the natural landform by converting land from native bush to pasture and, in the case of urban development, with impervious surfaces. Houses, shopping centres and office buildings provide places to live and work. Car travel between buildings is facilitated and encouraged by a complex network of roads and car parks. This infrastructure allows the successful operation of the cities, towns and region, and encourages social and economic development.

However from an urban context, this change from natural landforms and vegetative cover to impervious surfaces has two major effects on stormwater:

- Water quantity.
- Water quality.

1.2.1 Water quantity

Roofs, roads, parking lots and other impervious areas, stop water soaking into the ground, diverting it across its surface and increasing the quantity and rate of water discharging to streams and harbours. Impervious surfaces, compaction of soils and the absence of vegetation reduce the “sponge-like” storage capacity of the ground surface, reducing infiltration and the volume of underground water that feeds groundwater resources and stream base flows. These changes in the hydrological cycle cause flooding, stream erosion, sedimentation and loss of water for abstraction. Flooding and erosion can have direct effects on public safety, while erosion and sedimentation can affect the habitat of aquatic resources.

1.2.2 **Water quality**

Particles from car exhausts, tyres and brakes, silt, fertilisers, oils, litter and other by-products of urban life fall and collect on impervious surfaces. Many of these small particles adhere onto sediment, which stormwater run-off transports to streams, estuaries and harbours. Where the water is still, these contaminants settle out and accumulate. Other contaminants dissolve as rain passes over them and change the physical-chemical composition of stormwater. The accumulation of sediment, contaminants and changes to the chemical make-up of stormwater affect water quality and can then have significant effects on the viability of aquatic resources.

These effects will be detailed further in Section Two.

1.3 **Managing stormwater**

Stormwater management aims to protect human and ecological values by preventing or mitigating the adverse effects of stormwater quality and quantity on the human and aquatic environment.

Stormwater management techniques are generally divided into:

- Avoidance or source control practices (which prevent changes to the quality and quantity of stormwater by low-impact designs (LID), management practices or planning regulations); and
- Mitigative or structural practices (which reduce or mitigate changes that have already occurred to stormwater by constructed treatment devices).

Avoidance practices may be further categorised into:

- Site design practices which reduce the quantity of stormwater run-off, which is the basis for low-impact design; and
- Contamination control practices, which minimise the risk of contaminants coming into contact with stormwater.

Mitigative practices assume that the increase in run-off or contamination of stormwater has already occurred and attempt to reduce the contamination of off-site stormwater run-off or detain run-off to reduce flooding and erosion.

1.4 **Regulatory framework**

Section 30 of the Resource Management Act details the functions, powers, and duties of local authorities and Section 30(1)(f) requires regional councils to control discharges of contaminants into or onto land, air or water and discharges of water into water.

The Bay of Plenty Regional Council (BOPRC), through the Bay of Plenty Regional Policy Statement, Bay of Plenty Regional Coastal Environment Plan (Coastal Plan) and the Bay of Plenty Regional Water and Land Plan (RWLP) provide significant direction through objectives, policies and methods for the management of stormwater and expected outcomes.

Given the breadth of policies within these documents relating to stormwater management, these policies have not been reproduced here. For context the themes of these policies include:

- (a) To avoid, remedy or mitigate the potential adverse effects of discharges to freshwater and marine receiving environments;
- (b) For discharges to meet discharge quality standards and quality standards of the relevant receiving environment;
- (c) Taking into account the cumulative effects of smaller discharges;
- (d) A preference for discharges to be disposed to land in the first instance rather than directly to water, where appropriate;
- (e) To avoid the effects of discharges of Māori cultural values.

The Coastal Plan and the RWLP also detail the rules in relation to stormwater discharges including conditions related to permitted activities for the discharge of stormwater to land, freshwater and marine water.

Where permitted activity criteria cannot be met, the activity requires resource consent. It is intended that these guidelines will help fulfil the requirements of the objectives, policies and methods of the statutory documents.

1.5 **Technical objectives**

This guideline provides information on the selection and design of structural stormwater management devices. The primary objectives therefore relate to the removal of contaminants from stormwater, reducing peak discharges, and reducing site run-off by volume control. However, prevention is better than cure. To fully meet stormwater objectives, stormwater management solutions will be required that are integrated with development with all opportunities taken to prevent and minimise stormwater effects. This would include the use of LID approaches in site design and in-catchment master planning.

The objectives for managing stormwater are:

1.5.1 **Water quantity**

The primary water quantity objective of treatment devices is to match the pre-development and post-development peak flow rates for the 50% and 10% Annual Exceedance Probability (AEP) rainfall events, depending on catchment location. In addition, it is strongly advocated that those practices which reduce the total volume of stormwater run-off, such as water tanks, infiltration practices and biofiltration practices (evapotranspiration between storm events).

Where significant aquatic resources are identified in a freshwater receiving environment, additional water quantity requirements may be required.

Consideration of water quantity issues must also take account of the Bay of Plenty Regional Council Hydrological and Hydraulic Guidelines (2001/04) or successor (currently being updated at the time of guideline production). Those guidelines should be used by anyone carrying out the following activities:

- Culverts;
- Bridges;
- Services crossing a watercourse;

- Impermeable surfaces (roads, car parks);
- Stream realignment and channelling;
- Small embankments;
- Flood detention or soil conservation dams;
- Infilling of land acting as floodplains;
- Stormwater systems; and
- Erosion controls.

This guideline is consistent with the Hydrological and Hydraulic Guidelines but they both need to be considered to ensure there are no inconsistencies with for the proposal at hand.

1.5.2 **Water quality**

The primary water quality objective of the treatment devices in this guideline is to ensure that the water quality conditions of the relevant plan(s) are not exceeded. The main contaminants of concern are the following:

- Nutrients in-lake catchments;
- Sediment;
- Metals; and
- Other contaminants of concern on a case-by-case basis.

1.5.3 **Aquatic resource protection**

Aquatic resource protection is primarily concerned with maintaining the physical structure of the receiving system while promoting practices that provide habitat conditions conducive to a healthy ecosystem in receiving environments.

Designing for the infiltration or detention, storage, and release of stormwater flows over a 24-hour period reduces stream physical structure effects.

Other practices include riparian vegetation maintenance or enhancement, a reduction in the volume of run-off through revegetation, and use of roof run-off for domestic water purposes.

It is strongly endorsed that low-impact design principles are used in site development. These principles relate to the following:

- Reducing site disturbance;
- Reduce site impervious surfaces;
- Constructing biofiltration/bioretention practices;
- Water reuse;
- Creating natural areas; and
- Clustering development.

It is important to note that these are objectives only. They are not standard requirements. There will be situations where alternative approaches or design requirements may be appropriate.

Their application depends upon whether the stormwater issue they address is present, and the degree of implementation depends upon site and catchment circumstances. For example, water quantity objectives are unlikely to be required where stormwater is discharged to an open coastal environment where erosion, sedimentation and flooding issues are not present. While water quality is a significant issue in urban areas, the degree to which the water quality objectives are implemented depends on the practices that can be fitted into the available space. The same issues also apply to aquatic resource protection.

In addition, a catchment-wide discharge permit that is held by a local authority may provide for alternative requirements that have been defined through a catchment-wide analysis. Proposed individual developments should investigate whether an approved catchment-wide discharge permit exists for a given catchment, and if so, should check whether a proposed discharge can be authorised under the conditions of that permit.

1.6 **Statement of intent**

Applicants may propose alternative designs that meet the requirements of Regional Council plans, and as such, individual assessment will take place to ensure the design will achieve the relevant plan's goals and objectives.

In addition, these guidelines are being distributed primarily in digital format. One reason for that approach is the recognition that updates may be necessary due to increased knowledge relating to investigations or criteria changes both here and overseas. These guidelines will be updated whenever changes are warranted. Distribution can then be done more easily by posting changes on our website.

Part 2: Effects of land use on stormwater run-off

2.1 Urbanisation

2.1.1 The Hydrological Cycle

Water moves constantly between the atmosphere, ground and water bodies in an ongoing, worldwide cycle; the Hydrological Cycle. Processes such as rainfall, run-off, infiltration, evaporation, freezing and melting, continually move water between different physical phases, across regions, between fresh and saline waters, and into the atmosphere. Some processes, such as freezing in polar areas or deep infiltration to slow flowing aquifers, may keep water in one part of the cycle for long periods of time. All the time though, water is moving through the cycle.

Stages of urban land use - bush, rural, lifestyle, urban



The total volume of water in the cycle is finite. The amount of water vapour in the atmosphere plus the amount of rainfall, freshwater, groundwater, seawater and ice on the land is constant. Over time, physical factors such as climate or landform may change the volume of water at each stage in the cycle or sub-cycles, but in total no water leaves or enters the cycle.

Restricting the movement of water in one stage of the Hydrological Cycle will proportionally increase its movement in another. This occurs during urbanisation. The pictures above show the typical phases of urbanisation; through native forest, pasture, subdivision and mature urban land use. In a natural state, bush, trees and grass cover a catchment, which intercept rainfall and let it infiltrate into the ground.

Urbanisation creates impervious surfaces, which reduce vegetative interception, depression storage, infiltration and surface roughness (flow retardation). The excess water now runs off more quickly and increases the flow rate and volume of stormwater for a given storm event.

To illustrate these changes, Table 2.1 gives estimates of the proportion of movement by each process before and after development. These figures represent typical proportions for non-volcanic soils. The 1,400 mm of rainfall selected represents typical rainfall in Rotorua or Whakatāne.

Table 2.1 Components of a typical Hydrological Cycle.

Component	Pre-development (mm)	Post-development (mm)
Annual rainfall	1,400	1,400
Total run-off	378	812
Deep infiltration	70	11
Shallow infiltration	350	117
Evaporation/transpiration	606	455

2.1.2 Non-point source pollution

Impervious surfaces also collect contaminants derived from everyday urban life. These could be anything from litter, dust, decomposing vegetation or oils, to exhaust emission particles. Roads, in particular, collect by-products from vehicle wear and tear and combustion by-products. In the context of stormwater management and this guideline, these by-products are all termed “contaminants”.

Stormwater run-off moves contaminants off impervious surfaces, through drainage pipes and into water bodies. Litter and larger particles are washed off directly while the (very small) contaminant particles attach more to fine silt and clay particles and become readily transportable. Heavier particles drop out of suspension close to the ends of stormwater pipes while finer silts settle and accumulate further away in still, sheltered sections of water. This accumulation of contaminants from wide areas of developed urban land is termed “non-point source” pollution.

Typical example of street run-off



The effects of non-point source pollution are diverse. Persistent contaminants such as metals and toxic organics accumulate in sediment and have toxic ecological effects. Being mineral based, they don't decompose. Other contaminants such as sediment physically affect habitat, for example by smothering.

In some cases, these contaminants occur naturally in the environment. However, it is important to remember that impervious surfaces and stormwater pipes collect contaminants together, transport them and allow them to accumulate in places that they would not normally end up, and in much higher volumes and concentrations.

2.2 Key effects

Many of the effects of stormwater are only significant when considered cumulatively. The water quality and flooding effects of stormwater from an individual site may be relatively minor. If we consider a 10% increase in peak flow from a 1 ha site, downstream flood levels may only increase 1 mm or less. However, allowing an increase in flood levels on an individual site basis is an ad hoc approach, which neglects the sum total of all potential development in a catchment. Therefore, in addition to any site-specific effects, stormwater effects must be considered on a cumulative basis.

The three key effects of urban stormwater on the environment are:

- 1 Water quantity - flooding and erosion risks to humans and their property from altered hydrology and development too close to existing watercourses.
- 2 Water quality - threats to human health and receiving systems from changes to the physical-chemical nature of water and sediment.
- 3 Aquatic resources - loss of freshwater aquatic resources due to both altered hydrology and non-point source pollution. In particular, this considers the physical effects of stormwater on the freshwater environment.

2.3 Water quantity

2.3.1 General

Stormwater drainage systems are generally designed for a moderate level of performance and adopt approximately a 10% AEP event for pipe sizing. However, the importance of more severe, less frequent events is acknowledged and allowance is made for overland flow paths for events up to the 2% or 1% AEP. These two systems are termed the primary and secondary drainage systems. To protect the public and their property, the Building Act requires that habitable building floor levels have a contingency freeboard above the 2% AEP flood levels.

Flooding adjacent to waterways naturally occurs but urbanisation can increase flood potential due to either a gradual increase in peak flows (as a result of upstream development described in the example below), or where a constriction in the drainage channel (culvert, pipe drainage system) or stream channel reduces the flow capacity. However, the safe passage of flood flows is not always a case of “making the pipes big enough”. Water flow can change with its location along the channel due to changes in topography, channel dimensions, roughness, pools and other factors. The flood level at a given point is therefore determined by how quickly upstream conditions deliver water and how quickly downstream conditions allow it to get away. The equilibrium sets the flood level. However, the flow rate also changes with time, as the flood passes down a catchment. The flood level will therefore constantly change as both the physical-spatial factors and the variation of flow with time balance.

Flooding along Bell Road, Papamoa



2.3.2 Case study

Figures 2.1 and 2.2 set out the predevelopment and post development 50% and 10% AEP hydrographs for a 27.7 ha residential development, which was previously pasture. The site changed from two houses to 297 lots of about 600 m². For average sized houses, garages, driveways and subdivision roading, the imperviousness increases from less than 1% to 54%.

Figure 2.1 - Pre and post-development 50% AEP event

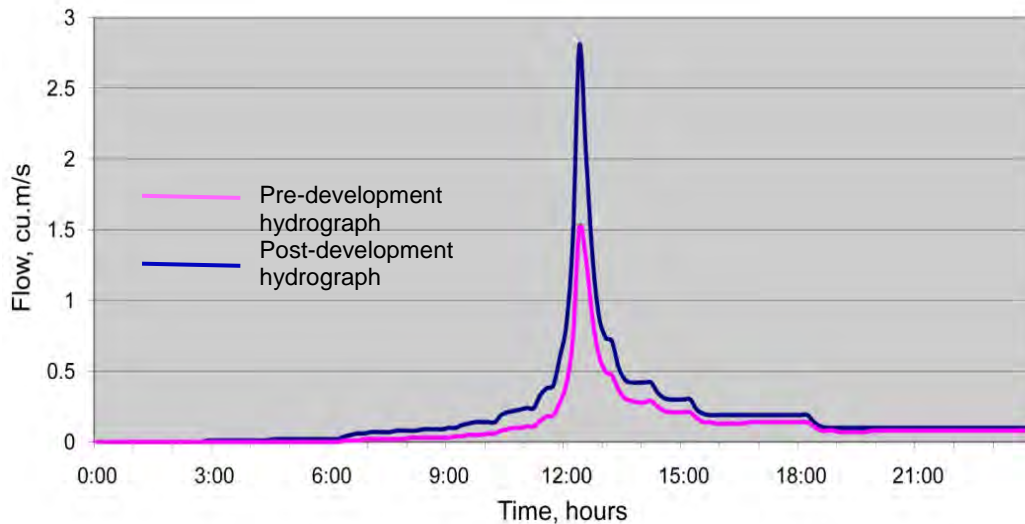
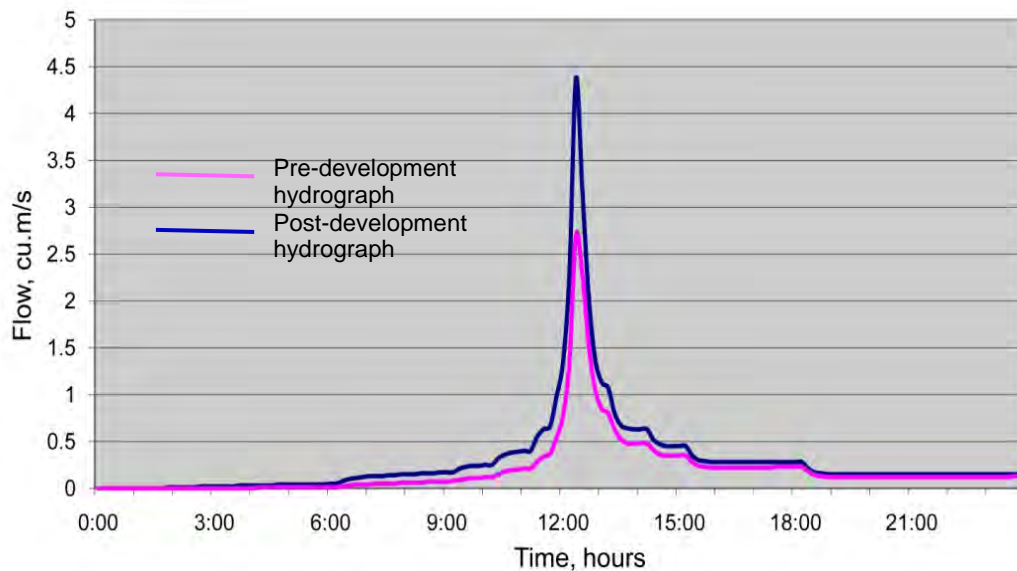

Figure 2.2 - Pre and post-development 10% AEP event



The hydrographs show that the peak flow rate for the 50% AEP event increases from 1.51 m³/s to 2.80 m³/s and for the 10% AEP event increases from 2.7 m³/s to 4.37 m³/s. The volume of stormwater run-off for the 50% AEP event increases from 10,200 m³ to 16,800 m³.

Stormwater from the development discharges to a stream. The extra peak flow in the watercourse raises the flood level. The flood level equivalent to the predevelopment 50% AEP event now occurs more frequently, resulting in more frequent bankfull flows. This results in more stream bank erosion.

2.3.3 Examples of effects

Extent of flooding

Flood levels are determined by equating the rate of inflow, outflow and available storage. Where the outflow is smaller than the inflow, levels rise. In the adjacent picture the flooding has risen above the stream channel and spread across large sections of farm land and road. Increased imperviousness upstream and loss of storage volume, by filling in the flood plain, would make the flood level higher still.



Channel constrictions

Channel constrictions such as culverts and bridges are potential flooding points. Constrictions usually include an overland flow path to pass events more severe than the design event and make allowance for blockage.



Lack of freeboard

To calculate freeboard and allow for the safe passage of flood flows, the ultimate development scenario upstream must be considered.

The consequences of getting it wrong are evident in the adjacent picture. A further rise in flood level will cause the bridge to become a constriction and raise upstream flood levels significantly.



Channel erosion

As bankfull flows increase in frequency with development, the channel erodes to become stable for the increased flow and velocity. As shown, this often results in a wider, "U" shaped channel, the most efficient shape for transporting the flow. During this process, aquatic habitat is lost.



Bank slumping

Stream flows are generally deepest and fastest on the outside of a bend. When flow velocities increase, the toe of a bank is often eroded, removing bank support. Eventually, the bank slumps. The recent slump is also susceptible to erosion and, unless stabilised, can keep retreating.



Channel incision

The adjacent picture shows a stream where high velocity and frequent high flows erode the channel base. The clay channel invert here has been cut down 0.5 m to 1.0 m.

Channel incision is a significant source of sediment, which affects water quality and downstream habitat.



2.4 Water quality

2.4.1 General

Evidence of the effects of urbanisation on water quality may be direct but is often indirect. When considered from a number of perspectives, a clearer picture of effects emerges. Three common methods for observing water quality effects include visual assessment, contaminant level measurement and biological surveys.

A very simple way to note stormwater effects is to walk along an urban stream and note the changes as the land use changes. Areas with greater levels of imperviousness discharge higher quantities of contaminants and water volumes that quickly change the structure and quality of the stream. Effects are particularly evident where the upper reaches of a catchment are undeveloped. A visual survey can document comparative downstream changes, such as channel erosion locations, fish pass blockages and areas of sedimentation.

Measuring water or sediment quality chemical parameters for comparison against accepted threshold values can also indicate effects on organisms. A number of studies of such urban run-off have been carried out in Auckland to monitor water quality effects. In addition, a number of biological studies have monitored chemical parameters in-situ and attempted to correlate the contaminant levels against the observed species condition and abundance. There is increasing evidence that catchment development strongly impacts on aquatic resources.

This section presents an introduction to common stormwater contaminants and includes an overview of visual and biological effects that are linked to development and non-point source pollution.

2.4.2 What are the contaminants?

- (a) Suspended sediments – These are soil, organic particles, and breakdown products of the built environment entrained in stormwater flow. They can be silt sized ($63\ \mu\text{m}$) or smaller. Sediments reduce light transmission through water, clog fish gills, affect filter-feeding shellfish, smother benthic organisms, change benthic habitats and fill up estuaries. Larger soil particles above silt sized are also contaminants, but typically exhibit different physical characteristics and settle much more quickly. These particles are sometimes termed “bed load” sediment.
- (b) Oxygen demanding substances – These are soil organic matter and plant detritus which reduce the oxygen content of water when they are broken down by chemical action and by bacteria. Chemical Oxygen Demand (COD), Total Organic Carbon (TOC) and Biological Oxygen Demand (BOD) are three measures of the consumption of oxygen in water. Fish generally need at least $5\ \text{g O}_2/\text{m}^3$ to stay alive. A large proportion of fish kills are caused by spills and oxygen demanding substances such as dairy effluent.
- (c) Pathogens – Pathogens are disease-causing bacteria and viruses, usually derived from sanitary sewers. Organisms such as faecal coliform and enterococci are often used as indicators of the presence of pathogenic organisms. However, the presence of an indicator organism does not necessarily prove a pathogen is present; merely that the risk is higher.
- (d) Concentrations of indicator organisms in stormwater in the pipe before discharge may exceed Ministry of Health guidelines for contact recreation and shellfish collection. However, dilution with receiving waters will usually mean public health criteria are not exceeded.
- (e) Metals – A variety of trace metal compounds are carried in stormwater in both solid and dissolved forms. The most commonly measured metals of concern are zinc, lead and copper. Zinc is often considered as a ‘keystone’ contaminant as it is often in a soluble state and its removal would indicate levels of removal for other contaminants also. Metals are persistent; they don’t decompose and they accumulate in sediments, plants and filter feeding animals such as shellfish. Elevated levels of metals cause public health issues and organisms avoid the affected habitat area (leading to a reduction in the number and diversity of fauna). At higher levels still, intergenerational deformities and tumours may occur, as has been recorded overseas.
- (f) Hydrocarbons and oils – The hydrocarbons in stormwater are generally those associated with vehicle use. They may be in the form of a free slick, oil droplets, an oil emulsion and in solution or absorbed to sediments.
- (g) Toxic trace organics and organic pesticides – A large range of trace organic compounds has been found in stormwater. Polycyclic Aromatic Hydrocarbons (PAHs) are one major group. PAHs are a group of over 100 different chemicals that are formed during the incomplete burning of coal, oil, and gas. Soot is a good example of a PAH. Organochlorine pesticides such as dieldrin, Lindane and Heptachlor constitute another main class of toxic organics.
- (h) Nutrients – Nutrients in stormwater are usually nitrogen and phosphorus compounds that stimulate plant and algal growth. This can cause daily fluctuations in dissolved oxygen concentrations, including phases of aerobic decomposition, which removes dissolved oxygen from the receiving waters.

- (i) Litter – Litter in stormwater is often referred to as gross pollution. It has a high visual and amenity impact, but limited effect on public health and ecological standards.
- (j) Emerging contaminants – Endocrine disruptors/synthetic compounds could be significant and the list will expand as our understanding of them increases.

In addition to the above contaminants, stormwater discharges have other physical and chemical effects that affect aquatic organisms and change how contaminants react. These include changes to temperature, pH, dissolved oxygen, alkalinity, hardness and conductivity.

In addition to individual contaminants, there is a potential compounding effect of various contaminants. In addition to the obvious direct effects of a specific contaminant level during a storm, there are other long-term 'chronic' effects due to the gradual accumulation of contaminants in a receiving system. Our lack of knowledge of compounding and accumulation factors demonstrates the need for a precautionary approach to resource protection.

2.4.3 Measurement of water quality effects

The concentration of contaminants in stormwater varies during a storm, from storm to storm, and from catchment to catchment. The Event Mean Concentration (EMC) is a measure of the average pollutant concentration during a storm. It is the pollutant load for the storm divided by the volume of run-off and will vary from storm to storm. The variation of pollutant concentration with time through a storm is termed a pollutograph. When comparing concentrations with water quality criteria, it should be borne in mind that individual samples may exceed the EMC by a large factor. Exceeding water quality guidelines does not necessarily lead to effects on the environment. An EMC value in stormwater may exceed water quality guidelines "in pipe" but may not following dilution in receiving water. Water quality criteria are therefore more often used as an indicator of receiving environmental health rather than a regulatory standard although BOPRC is moving towards using water quality effluent limits for consenting purposes.

Once contaminated sediments accumulate, their effect depends on factors such as spatial distribution, duration of exposure, dilution from deposition with cleaner sediments, and the rate at which the contaminants are assimilated (bioavailability) by organisms in the receiving environment.

Contaminant toxicity is described as chronic (effects are the result of a gradual accumulation over time) or acute (effects are the result of a sudden pulse).

2.4.4 Examples of effects

The following images illustrate the issues discussed.

Stream contaminants

The adjacent image shows urban stream water and sediment quality in an inner city stream. Effects include litter, inorganic material, turbidity in the water column, vegetative detritus and sediments.



The adjacent picture is a close-up of the same environment.

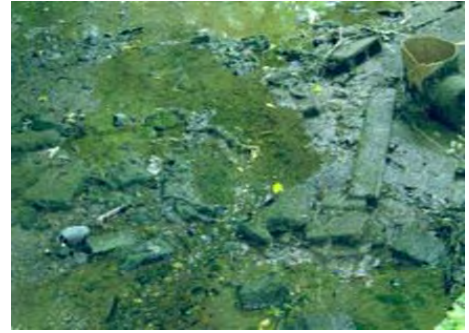

Sediment

Sediment from urban land uses and stream channel erosion often settles in estuaries. Low velocities and the saline environment assist particulate settling. Continual sediment delivery reduces light penetration and prevents plant food sources growing in the estuary, thereby affecting bottom dwelling organisms such as worms, crabs and shellfish, the base of the marine food web.



Litter

Stormwater systems typically receive inflow via a catchpit. "Back entry" catchpits have a slot set into the kerb behind the grate to improve the hydraulic capacity. However, the size of the slot (50 mm minimum) is sufficient to pass pieces of litter into the stormwater system and water bodies. The adjacent picture shows debris trapped in culvert bars.



Litter will then travel downstream from where it is generated and is an obvious example of how far stormwater pollutants may travel. Litter affects recreational amenity values and may compromise species habitat.

Litter in the environment has a strong effect on people's attitudes towards the environment. Litter is obvious and pervasive.

Benthic community health

Benthic species are creatures living in aquatic bottom sediments. Figure 2.3 gives an indication of benthic community health related to percentage of impervious surfaces in a catchment. While this specific graph is from Auckland, similar results have been obtained in the U.S., which would indicate that trends elsewhere would be expected to be similar. Clearly, greater levels of imperviousness adversely impact on sensitive aquatic insects.

Figure 2.2 provides a key reason why BOPRC is advocating low-impact design (LID) as an approach to urban development. Using LID principles can reduce adverse impacts from those anticipated with conventional development. Decreasing the volume of stormwater being discharged is a central tenet of LID and that volume reduction would reduce work being done on stream channel boundaries, improving stream habitat.

Figure 2.3 - Sensitive aquatic organisms versus impervious surface percentages

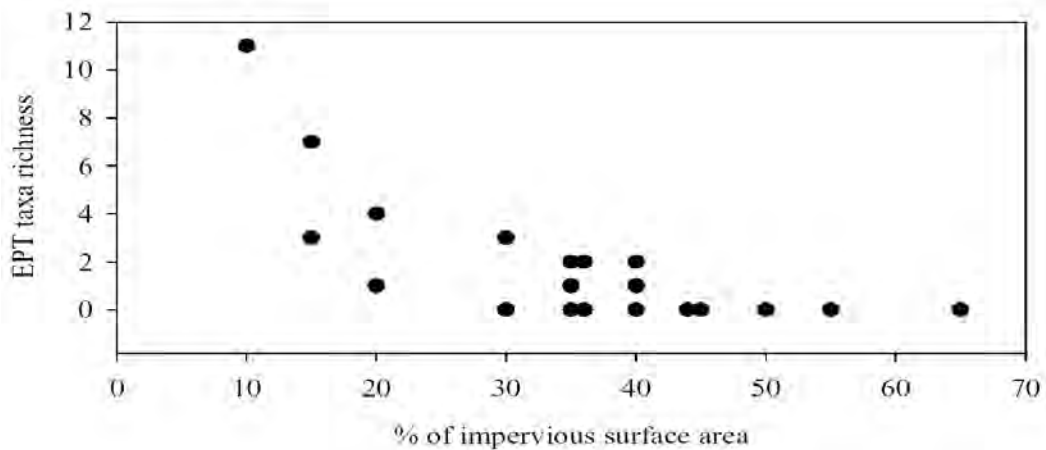

2.5 Aquatic habitat

2.5.1 General

Stream health is affected by all the water quality and water quantity factors that have been discussed in the previous sections. Hydrological factors are key factors in causing destabilisation of physical stream structure. However, it is very difficult to identify the combination of different factors that cause specific problems in stream health. Surrogate indicators are therefore used to indicate stream health.

Example of high sediment load in a local stream



One form of life that exists in streams is macro invertebrates. Macro invertebrates are aquatic insects that include grazers, shredders, collectors/browsers, piercers, suckers, filter feeders on detritus and predators. The presence of a diverse macro invertebrate community indicates consistently good water quality and a stable stream structure (available habitat). Any alteration of either of these parameters will be reflected in the macro invertebrate community. So where they are present, they are extremely valuable.

Fish are another barometer of health with their absence or presence providing a picture of the overall health of a stream. Typical fish found in the Bay of Plenty streams include banded kokopu, inanga, common bully, as well as eels and freshwater crayfish.

The increased frequency and magnitude of peak flows destabilises stream banks and increases sedimentation. Sedimentation can smother stable and productive aquatic habitats such as rocks, logs and aquatic plants. The roots of large trees are undercut and fall into the stream while new growth has less opportunity to become established. Deliberate removal of vegetation exposes soil on stream banks, a common feature of urban streams that makes them more vulnerable to erosion. The structural stability of the stream channel has a significant effect on the health of the aquatic ecosystem.

Horner (1999) assessed the effectiveness of structural practices for protection of stream aquatic resources from a catchment-wide perspective. Horner makes a number of interesting statements although they need to be further documented. Key findings were:

- Until catchment total impervious area exceeds 40%, biological decline was more strongly associated with hydrologic fluctuation than with chemical water and sediment quality decreases. Accompanying hydrologic alteration was loss of habitat features, like large woody debris and pool cover, and deposition of fine sediments.
- Structural stormwater management practices at current densities of implementation demonstrated less potential than the non-structural methods (riparian buffers, vegetation preservation) to forestall resource decline as urbanisation starts and progresses. There was a suggestion in the data, though, that more thorough coverage would offer substantial benefits in this situation. Moreover, structural stormwater management practices were seen to help prevent further resource deterioration in moderately and highly developed catchments. Analysis showed that none of the options is without limitations, and widespread landscape preservation must be incorporated to retain the most biologically productive aquatic resources.
- Structural stormwater management practices can make a substantial contribution to keeping stream ecosystem health from falling to the lowest levels at moderately high urbanisation and, with extensive coverage, to maintaining relatively high biotic integrity at light urbanisation.

The following pictures and text detail aquatic resource impacts related to stream channel modification, barriers to migration and sedimentation.

Stream structure

Urban streams are often straightened and “improved” to increase the hydraulic capacity as seen in the adjacent picture. This process removes habitat such as stream meanders, pool/riffle structures. Food sources from in stream vegetation and sediments are lost.



Barriers

Culverts, weirs and other in-stream structures form barriers to fish passage. This culvert is above the base flow water level preventing fish migration. Climbing fish species cannot pass through the culvert because it overhangs the stream and the shallow depth of water inside the pipe gives high velocities. The culvert shown has also caused channel and stream bank erosion, producing turbulence, which discourages migration by slow swimming fish species.



Sedimentation

Low flowing sections of streams are susceptible to sedimentation as seen in the adjacent picture. This can remove habitat in a similar way to channel lining, by infilling pool and riffle stream stretches and smothering food sources and bottom dwelling animals.



2.6 Bibliography

- Roper D.S., Thrush S.F., Smith D.G., The Influence of Run-off on Intertidal Mudflat Benthic Communities. *Marine Environmental Research*, No 26., May 1988.
- Lagasse P.F. et al., Stream Stability at Highway Structures, US Department of Transportation, Federal Highway Administration, Hydraulic Engineering Circular No. 20. Feb 1991.
- Williamson, Hume, Pridmore, Smith, Thrush, Wilcock, Factors Affecting the Fate of Contaminant in the Manukau Harbour. Water Quality Centre DSIR and Glasby DSIR. Consultancy report 6109/2 October 1991.
- ARC, An Assessment of Stormwater Quality and the Implications for Treatment of Stormwater in the Auckland Region, Technical Publication No. 5, April 1992.
- ARC, Tamaki Catchment and Estuary Review of Water Quality, Technical Publication No. 20, Dec 1992.
- Williamson, B., Urban Run-off Data Book: A Manual for Preliminary Evaluation of Stormwater Impacts. NIWA, water Quality centre publication; 1993, 2nd Ed.
- NIWA, Effects of future urbanisation in the catchment of the Upper Waitemata Harbour : Ecological Impacts. NIWA Consultancy Report No. ARC100. April 1994.

- Williamson R.B. and Wilcock R.J., The distribution and fate of contaminants in estuarine sediments. Recommendations for environmental monitoring and assessment, NIWA, ARC Technical Publication 47 September 1994.
- McKergow, L., Urban Stormwater Quality, Pakuranga, Auckland, ARC Technical Publication 49, September 1994.
- ARC, The Environmental impacts of Urban Stormwater run-off, ARC Technical Publication No 53, May 1995.
- NIWA, Assessment of Water and Sediment Toxicity Associated with Stormwater Treatment Facilities, NIWA, October 1995, Consultancy Report ARC242.
- Snelder, Ton, Comparison of run-off quality from roads versus other urban land-uses, NIWA, Consultancy report No ARC60501, October 1995.
- NIWA, Ecological Monitoring programme for the Manukau Harbour : Report on data collected up to February 1997, NIWA report published as ARC Technical Publication No. 85, August 1997.
- ARC, Manukau Harbour shellfish Quality Survey 1997, Technical Publication No 97, September 1998.
- Horner R.R. & May C.W., Regional Study Supports Natural Land Protection as Leading Best Management Practice For Maintaining Stream Ecological Integrity, Comprehensive Stormwater and Aquatic Ecosystem Management, First South Pacific Conference, Feb 1999, Vol 1, p 233-248.
- Williamson B., Morrisay D.J., Swales A., The Build-up of contaminants in urbanised estuaries, Comprehensive Stormwater and Aquatic Ecosystem Management, First South Pacific Conference, Feb 1999, Vol 1, p59.
- Crunkilton R., Kleist J., Bierman D., Ramcheck j., DeVita W., Importance of toxicity as a factor controlling organisms in an urban stream, Comprehensive Stormwater and Aquatic Ecosystem Management, First South Pacific Conference, Feb 1999, Vol 1, p109.

Part 3: Receiving environments

Having an awareness of where water goes and the sensitivity of receiving systems will determine, to a large extent, requirements for stormwater management. For the most part, people don't think of where contaminants go once they leave a site other than they "go away". Having a greater understanding of where water drains to and the recognition that those receiving systems have value, are threatened and require a greater level of protection should improve awareness and action.

Receiving systems include the following systems:

- Streams and rivers.
- Ground.
- Estuaries.
- Harbours.
- Open coasts.
- Lakes.

Each of these systems will be discussed individually to provide context for their value.

3.1 Streams and rivers

Streams and rivers provide a means of conveyance of stormwater from the tops of catchments to lakes, estuaries, harbours and open coast areas. Often streams and rivers could be attractive places and provide a connection to nature and that aspect should not routinely be ignored.

As water in streams and rivers only moves in one direction (downhill) there is a constant loss of organisms and materials to the sea. The stream and river community is totally dependent on materials entering the system from mostly terrestrial ecosystems, typically as particulate matter (leaves, organic and inorganic matter). As a result, different streams and reaches of streams have different aquatic communities. Upland, fast-flowing streams with stony beds differ from slow-moving lowland rivers with muddy bottoms.

The dynamic nature of wet-weather flow regimes and water quality make it difficult to assess the impact of urbanisation and stormwater on aquatic ecosystems. The best way to determine whether a given stream or river is healthy is to consider two main components of stream systems:

- Habitat.
- Biology.

Urbanisation destabilises stream and riverbanks and increases sedimentation and transport of urban contaminants into streams. Sedimentation can smother bottom dwelling organisms and increased sun light can increase stream temperatures. Ecosystem function and quality increases with increased complexity, and the more complex the habitat, the more complex the ecosystem functions.

Biology in streams and rivers includes the following:

- Periphyton – algae, bacteria and fungi that covers the bottom of slow moving streams and blue-green and filamentous green algae that flourish in hard rocky substrates that provide firm footing.
- Macrophytes – plants that are usually rooted and mostly submerged or floating. Macrophytes act as a physical surface for periphyton and insects.
- Benthic macroinvertebrates – bugs that process and utilise the energy entering streams from either organic materials or waste from human or animal sources. Macroinvertebrates are an excellent means to assess stream health, as certain species only exist where there is good water quality.
- Freshwater fish – absence or presence of fish may provide a picture of overall health of a stream or river. Absence of fish from a stream or river could be related to barriers to fish passage downstream, habitat loss or water quality issues.

The main factors influencing stream and river biology include:

- Physical habitat.
- Temperature.
- Dissolved oxygen.
- Suspended sediments.
- Stream flow.
- Nutrients.
- Light.
- Contaminants.
- Instream barriers.
- Loss of riparian vegetation.

Example of a stream having good riparian cover



In urban streams and rivers it is generally hard to ascribe a specific reason for poor biology, as it often is a combination of most of the factors contained in the above list.

For projects that drain to them, the main issues of concern relate to both water quantity and water quality. Depending on the location of the project in a catchment peak flow control may be an issue. In addition stream channel physical structure may be a concern and consideration given to either extended detention or reducing total volume of stormwater flows by either infiltration or evapotranspiration.

Water quality is also a concern on urban stormwater discharges on streams and rivers and will generally be an issue that must be considered and mitigation provided in regional plans.

The Bay of Plenty region is home to a number of rivers and tributaries (Wairoa, Kaituna, Tarawera, Rangitāiki, Whakatāne, Waimana, Waiotahi, Waioeka, Otara, Motu and Raukōkore), which have ecological, social and economic values.

The quality of these rivers is affected by local human activities such as agricultural run-off and point source discharges from farming activities, oxidation ponds and industrial sites. Monitoring of these rivers has shown the average nutrient concentrations to be high and water clarity often being low.

3.2 Ground

There are two issues related to ground and potential contamination.

- Contamination of soils.
- Migration of contaminants to groundwater.

3.2.1 Contamination of soils

Contamination of soils can occur as a result of past or present land use of a given site that could include:

- Use of agricultural chemicals (particularly glasshouses, orchards, vineyards, market gardens).
- Disposal of wastes.
- Accidental spillage or leakage of chemicals.
- Storage or transportation of raw materials, finished products or wastes.
- Migration of contaminants into a site from neighbouring land, either as vapour, leachate or movement of liquids through the soil.

Migration of contaminants to ground



Land where contaminants are present in the soil, sediment, groundwater or surface water could indicate a short or long-term risk to human health and the environment. Impacts on human health from contaminated soil can arise from ingestion of soils, consumption of vegetables from the site, uptake and subsequent bioaccumulation by plants and animals.

Impacts on the environment can occur from a number of routes including direct uptake of contaminants by plants and animals, or migration of contaminants to ground or surface waters. Some contaminants, such as copper or zinc, are far more toxic to aquatic plants and animals than to humans.

3.2.2 Migration of contaminants to groundwater

Passage of water through the ground is part of the water cycle where water soaks into the ground and flows through it to an aquifer. It is mainly derived from rainfall that has soaked into the ground rather than run-off that travels over the ground surface. It can also be derived from water soaking into the ground from streams or lakebeds.

Water that soaks into the ground moves down through soil pores or rock fractures until it hits the water table. The zone above the water table is known as the unsaturated zone. Below the water table soil pores or rock fractures are fully saturated and the groundwater mainly moves laterally through these pores and fractures. A representation of groundwater movement is shown in Figure 3.1.

Groundwater underlies most of New Zealand. However, differences in geology, hydraulic properties of the soil or rock, topography, recharge rates and relationships with surface waters mean that groundwater flow and bore yields are greater in some areas than others.

In terms of contamination of groundwater, most of the groundwater quality in the country is good but there are areas having groundwater aquifers where fractures in bedrock make for rapid infiltration of surface run-off and the potential for transfer of contaminants to groundwater could potentially occur.

Principal concerns relating to groundwater are water quality and groundwater recharge. Poor stormwater run-off quality can contaminate groundwater and increased impervious surfaces can reduce groundwater recharge. While recharge of groundwater can be important, it is not recommended that infiltration practices accept untreated stormwater run-off for three reasons:

- Potential clogging of the infiltration system;
- Potential migration of contaminants to groundwater, especially during accidental spills; and
- The ground itself is a receiving system and contamination of soils needs to be prevented.

The Institute of Geological and Nuclear Sciences Ltd. reported on groundwater quality in New Zealand (2007) and identified two major national-scale groundwater quality issues:

- Contamination with nitrate and/or microbial pathogens, especially in shallow wells in unconfined aquifers; and
- Naturally elevated concentrations of iron, manganese, arsenic and/or ammonia, especially in deeper wells in confined aquifers.

The health-related guideline values for nitrate and indicator bacteria are exceeded at 5% and 20% of the monitoring sites for which indicator data were available, respectively.

Water quantity issues are only indirectly related in that storage of excess run-off needs to be provided if the run-off rate exceeds the rate of infiltration.

Figure 3.1 - Groundwater movement

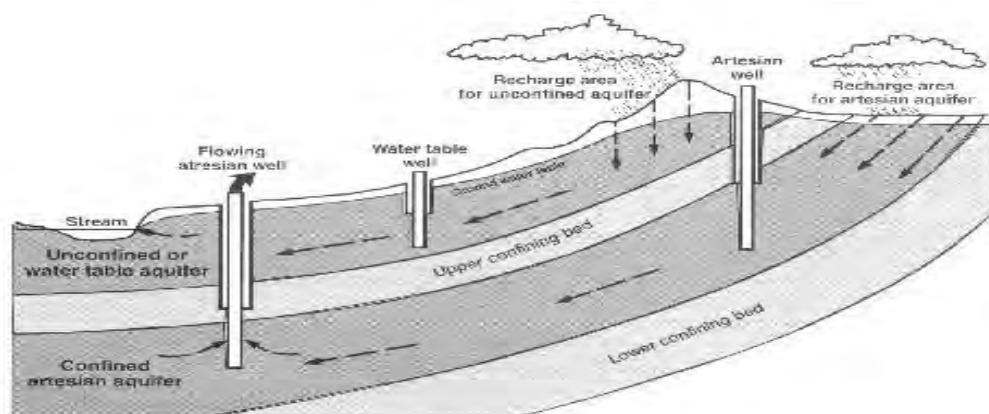

3.3 Estuaries

Estuaries are low energy, depositional zones where the sea meets streams and rivers. They tend to be semi-enclosed coastal bodies of water with one or more rivers or streams flowing into them and with a free connection to the sea. Estuaries are often associated with high rates of biological productivity.

From a New Zealand perspective, estuaries seethe with bacteria, mud worms, crabs, migrating fish, mangroves and oystercatchers. This system has evolved in the mud flats and is vulnerable to time, tide, erosion, contamination and other effects of human activity.

Estuary feeding into Tauranga Harbour



An estuary is typically the tidal mouth of a river and they are often characterised by sedimentation from silts carried from terrestrial run-off. They are made up of brackish water. Estuaries are marine environments, whose pH, salinity, and water level are varying, depending on the tributaries that feed them and the ocean that provides the salinity. There are several types of estuaries:

- Salt wedge – in this situation the river output greatly exceeds the marine input and there is little mixing.
- Highly stratified – river outputs and marine input are more even, with river flow still dominant. Turbulence induces more mixing of saltwater upward.
- Slightly stratified – river input is less than the marine input. Turbulence causes mixing of the whole water column.
- Vertically mixed – river input is much less than marine input, such that the freshwater contribution is negligible.
- Inverse estuary – these are located in areas with high evaporation and where there is no freshwater input.
- Intermittent estuary – this type of estuary varies dramatically depending on freshwater input, and is capable of changing from a wholly marine embayment to another estuary type.

Due to estuaries being low-energy environments and having a high salinity, they are depositional zones where sediments and contaminants become deposited. Environmental monitoring by the BOPRC has shown that the highest metal concentrations occur near urban and industrialised areas (Park, 2009). It needs to be re-emphasised that metals do not decompose. Estuaries are sinks where contaminants accumulate and concentration levels can be expected to increase.

In terms of stormwater management, neither peak flow nor stream erosion are considered concerns and the main issue is water quality. In addition, water quality may relate to a wide range of contaminants.

From a regional context, the Bay of Plenty region has a number of estuaries (the Maketu, Little Waihi, Whakatāne, Waiotahi, Waimapu, Waioeka/Otara, etc.), which are considered as valued receiving environments due to their wide range of natural habitats, biological diversity and opportunities for recreational and commercial use.

3.4 Harbours

Harbours are primarily natural landforms where a body of water is protected and deep enough to furnish anchorage for ships. They differ from estuaries in that tidal action is greater and rates of deposition of sediments are less. Sedimentation does still occur and most harbours of the world require dredging to maintain shipping channels.



The region is fortunate to have three harbours (Tauranga, Whakatāne and Ōhiwa). For the most part they occupy drowned valley systems cut in marine sediments of Miocene Age (15–25 million years ago). Table 3.1 provides a comparison of the mean concentration of metals from various local surveys. Copper, lead and zinc are the metals which are clearly elevated above background levels.

Table 3.1 Mean sediment concentration of metals from the various surveys around the Bay of Plenty (Park, 2009).

Study	As	Cd	Cr	Hg	Ni	Cu	Pb	Zn
Stormwater outfalls 0-10 m	4.2	0.07	5.8	<0.1	1.9	7.8	15.4	68
Stormwater outfalls 50 m	3.8	0.08	4.9	0.08	2.1	13.6	18.8	52
Tauranga - 2006	3.5	0.08	4.4	0.04	1.7	2.3	4.3	27
Ōhiwa - 2006	4.5	0.02	5.9	0.04	4.4	5.0	5.1	29
CEE 2006-2008*	4.7	0.05	5.9	0.04	3.2	2.5	3.7	24
Tauranga - 1991	3		3	0.03		2	6	21

*Results on sediment fraction <500 microns – all others on whole sample.

A study of stormwater sediments in drains/streams around Tauranga (McIntosh, Deely, 2001) showed that high levels of copper, lead and zinc had the potential to impact harbour sediment ecology.

From a stormwater management perspective, neither water quantity peak flows nor stream channel erosion are considered as issues needing to be addressed if harbours are the receiving system of concern.

From a water quality perspective, harbours are not as sensitive as estuaries and streams from a contamination standpoint and implementation of stormwater management will probably relate to the magnitude of the project being proposed and the requirements of the regulatory authority.

From a water quality perspective, Tauranga Harbour can have nuisance blooms of sea lettuce that effects harbour appearance. Sea lettuce is native to New Zealand but can become a problem in shallow, clear waters that have elevated nutrient loads.

3.5 Open coasts

Open coasts are the line of demarcation between the land and the ocean. They are dynamic environments and go through constant change. Natural processes, particularly sea level rise, waves and various weather conditions have resulted in erosion, accretion and reshaping of coasts as well as flooding and creation of continental shelves and drowned river valleys.

Bay of Plenty Coastline



Coasts face many environmental challenges relating to human-induced impacts. The human influence on climate change is considered to be a major factor of the accelerated trend in sea level rise. In addition urban development of coastal land contributes to aesthetic problems and reduced natural coastal habitat.

While not as serious as pollution issues in streams, estuaries or harbours pollution can be an ongoing concern on coasts with garbage and other contaminants littering beaches and coastlines. A large part of the global population inhabits areas near the coast, partly to take advantage of marine resources but also to participate in activities that occur at port related areas.

Depending on littoral drift, the major concern on urban land use adjacent to open coasts would be litter control. When looking at impacts related to open coasts, a primary concern has been sewage contamination of beaches, which is not necessarily a stormwater related issue. Litter is a visible contaminant and can be addressed through a number of actions including routine clean-up or maintenance.

The Bay of Plenty has approximately 300 km of coastline, which includes estuaries, salt marshes, cliff, intertidal rock platforms and sand and gravel beaches.

3.6 Lakes

A lake is a body of water that is contained in a body of land and, in the context used here, contains fresh water. Most lakes have an outfall but some do not. Lakes can be manmade or natural.

Lake Rotorua

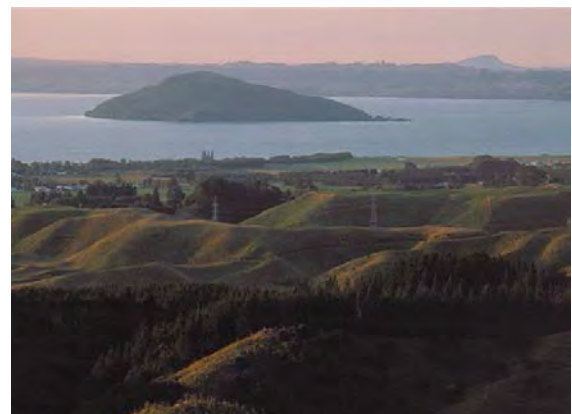

Pollution of lakes can occur through a number of factors. The amount of nutrients entering a lake can cause eutrophication. This is caused by nutrient loadings stimulating excessive plant growth, which in turn decreases the amount of oxygen in the water and eventually causes fish and animal kills. Ecology of lakes is very different from that of streams due to standing water, temperature effects, and contaminant accumulation.

Healthy lakes contain nutrients in small quantities from natural sources. Extra inputs of nutrients (nitrogen and phosphorus) disrupt the balance of lake ecosystems by stimulating population explosions of algae and aquatic weeds. BOPRC has identified in numerous studies that nutrients causing algae blooms are a problem in the region's lakes, especially the Rotorua lakes. The algae sink to the lake bottom after they die, where bacteria decompose them. The bacteria consume dissolved oxygen in the water while decomposing the dead algae. Fish kills and foul odours may result from oxygen depletion. Metals such as copper, zinc, lead, mercury, etc. can also impact on aquatic life by contaminating organisms. By moving up the food chain from worms to insects to fish could then cause a human health problem.

Due to lower horizontal velocities, materials that enter a lake tend to remain in the lake. They are, in effect, sinks where contaminants can accumulate. Figure 3.3 shows lake trophic levels for the Rotorua Lakes (BOPRC Lake Fact Sheet #3) and clearly shows that degradation due to nutrient enrichment is occurring.

In general, New Zealand lakes are primarily impacted by nutrients. Sediment can also reduce lake clarity but, on new development, the primary cause of sediment relates to erosion and sediment control during construction rather than sediment-generated post-construction.

NIWA reported on lake water quality (NIWA, 2006) and summarised the current status of 121 lakes. The land use that drained to the lakes was related to four land-cover classes: alpine, native forest/scrub, exotic forest and pasture. Urban land uses were not identified nor considered. NIWA considered phosphorus, nitrogen, clarity, suspended solids and temperature. Median values of total nitrogen, total phosphorus and chlorophyll a were four to six times higher in pasture classes than in native bush.

The broad national picture is of high water quality in deep lakes at high altitude and in unmodified catchments, and of lower water quality in modified catchments, especially in small, shallow and warm lakes. Although lake water quality was degraded in both exotic forest and pastureland catchments, pasture use was associated with the worst water quality, most notably in the cases of extreme deterioration.

Figure 3.3 - Rotorua Lakes Trophic Levels

Trophic Level	Lake Type	Perceived Lake Quality
0.1–1.0	Ultra-microtrophic	
1.1–2.0	Microtrophic	
2.1–3.0	Oligotrophic	
3.1–4.0	Mesotrophic	
4.1–5.0	Eutrophic	
5.1–6.0	Supertrophic	
6.1–7.0	Hypertrophic	

Lake Trophic Levels and Lake Types

Lake	3 yearly average TLI 2002 TLI units	3 yearly average TLI 2003 TLI units	3 yearly average TLI to 2004 TLI units	Regional Water & Land Plan TLI units	Long Term Trend In terms of TLI units over analysis period	Lake Type based on Trophic Level
Okaro	-	5.5*	5.5*	5.0	Degraded but definite improvement	Supertrophic
Rotorua	4.8	4.9	4.9	4.2	Degraded No change	Eutrophic
Rotoehu	4.7	4.7	4.6	3.9	Degraded No change	Eutrophic
Rotoiti	4.0*	4.3*	4.3	3.5	Definite degradation	Eutrophic
Rotomahana	-	3.6*	3.7	3.9	Possible improvement	Mesotrophic
Rerewhakaaitu	3.4*	3.2	3.3	3.0	No change	Mesotrophic
Tikitapu	3.0*	3.1*	3.2	2.7	Probable degradation	Oligotrophic
Okataina	2.8*	3.0*	3.0	2.6	Possible degradation	Oligotrophic
Tarawera	2.8*	2.9*	2.9	2.6	No change	Oligotrophic
Rotoma	-	2.5*	2.6	2.3	No change	Oligotrophic
Rotokakahi	-	-	-	3.1	-	Mesotrophic

*Lake Trophic Level Index value as a three-year average for the Rotorua lakes, a target value in the Regional Water and Land Plan, and long-term trend. *Two Year average.*

Extrapolation of the lake environment categories to the nationwide database of 3,820 lakes suggests that approximately 60% of New Zealand lakes are still likely to have excellent or very good water quality; these are lakes in cold regions with high native and low pasture cover. However, approximately 30% of lakes are likely to have very poor to extremely poor water quality. Lowland lakes are especially likely to have poor water quality.

3.7 Overall discussion of stormwater and receiving environments

To put the previous discussion into a context for stormwater management, the following Table 3.2 provides a brief snapshot of receiving environments and stormwater issues. The table is meant as a general guide and does not substitute for regulatory requirements required by consenting authorities. Contact should be made with the appropriate local council to ensure that any local requirements are complied with.

Table 3.2 Receiving environments and stormwater issues.

Receiving system	Flooding issues	Stream erosion issues	Water quality
Streams	May be a priority depending on location within a catchment	High priority if the receiving stream is a natural, earth channel	High priority
Ground	Not an issue depending on overflow	Not an issue	High priority
Estuaries	Not an issue	Not an issue	High priority
Harbours	Not an issue	Not an issue	Moderate priority
Open coast	Not an issue	Not an issue	Lower priority
Lakes	Not an issue	Not an issue	High priority

3.8 Bibliography

- Geological and Nuclear Sciences Ltd, Groundwater Quality in New Zealand: State and Trends 1995 - 2006, Published by the Ministry for the Environment, Publication number: ME 831 August 2007.
- Park, S., Bay of Plenty Marine Sediment Contaminants Survey 2008, Bay of Plenty Regional Council, Environmental Publication 2009/01, January 2009.
- McIntosh, J, Deeley, J., Urban Stormwater, Environment BOP Environmental Report 2001/06, Bay of Plenty Regional Council, 2001.
- Auckland Regional Council, Regional Discharges Project Sediment Quality Data Analysis, Technical Publication No. 245, June 2004.
- Environment Bay of Plenty, Lake Facts, Rotorua Lakes #3, Lake Trophic Level, January 2005.
- NIWA, Lake Water Quality in New Zealand: Status in 2006 and recent trends 1990 - 2006, published by the Ministry for the Environment, Publication number: ME-832, December 2006.

Part 4: Site resources

4.1 Introduction

Just as it is important to recognise the value of receiving systems, it is also important to recognise resources that are available on individual sites.

Site resources are those natural features or site characteristics, which, to a large extent, provide a benefit to receiving systems through their existence. They provide a benefit to the general public by their continued function to reduce peak rates and volumes of stormwater run-off, provide for water quality treatment, and prevent damage to improved or natural lands either on site where the site resources exist, or downstream of those resources.

Site resources have intrinsic and other values for habitat and biodiversity regardless of their stormwater functions. They can include a wide variety of items, but those discussed here are considered primary resources that should be recognised and considered in site development and use. In terms of this section, the following site resources are important primarily for their stormwater management benefits. Some of the benefits are less obvious than others, but all provide a benefit.

- Terrestrial ecology and landscape form.
- Wetlands.
- Floodplains.
- Riparian buffers.
- Vegetation.
- Soils.
- Slopes/topography.
- Other natural features.
- Linkage with site development.

Site resources often overlap. For example, a riparian buffer may lie within a floodplain or a forested area. In this section, they are discussed individually although their benefits may be, and generally are, cumulative.

4.2 Terrestrial ecology and landscape form

It is often said that the three principal economic factors that drive real estate prices are: location, location and location. The same is true of natural resources and site resources. Where natural features are located on a site is just as important as the characteristics of the natural features themselves. The importance of the position of ecological features in the landscape has spawned an entire field of study called “landscape ecology”.

There are several basic principles of ecology that can be used to improve the quality of receiving environments. These principles apply to all site resources.

- Retain and protect native vegetation (native forest, regenerating native scrub and forest, wetlands, coastal forest/scrub) - these ecosystem types have important intrinsic values, and provide different habitats for native flora and fauna and different ecological functions.
- Allow natural regeneration processes to occur (e.g. pasture => scrub => forest; wet pasture => wetland).
- Undertake weed and pest control to improve the natural values of native vegetation, allow natural processes and seed dispersal mechanisms to occur.
- Replant and restore with native plants to provide vegetation cover, which is characteristic of what would once have been there and/or which reflects other local remnants in the area.
- Restore linkages with other natural areas or ecosystems (e.g. using waterways and riparian areas, linking fragmented forest remnants, linking wetland ecosystems and freshwater ecosystems to terrestrial forest/scrub remnants). Native species need extensive areas of vegetation to survive.
- Our knowledge is limited (need for a factor of safety).

4.2.1 **The ecological values of site resources**

It is important to retain natural areas (including scrub, forest, and wetlands) on a site for their biological diversity and intrinsic values, which include the following:

- They are important for their values as characteristic examples of biodiversity;
- The diversity of species or ecosystem types that they contain;
- Containing rare or special features or unusual ecosystem types;
- Their value as habitats for indigenous species and the level of naturalness;
- Their ability to sustain themselves over time (e.g. available seed sources, active regeneration, bird dispersal processes active, level of weeds and pests and outside influences controlled);
- Being of adequate size and shape to be viable; and
- If they are buffered or they provide a buffer to habitats or natural areas, from outside influences (e.g. scrub on edges of native bush, intact sequences from estuarine to terrestrial, from freshwater to terrestrial, from gully bottom to ridge top); and provide linkages with other natural areas in an area (corridors for native birds, invertebrates).

The following criteria for the evaluation of ecological significance of native vegetation provide a set of basic principles for the determination of ecosystem significance. These are paraphrased from the Protected Natural Areas Programme survey methodology (Myers *et. al*, 1987).

4.2.2 Representativeness

It is important to protect what is common and characteristic of the ecology of an area. Natural areas that are representative of the ecological communities once formerly present in a given area (e.g. an ecological district) are significant. It is not only rare and unusual features that are important. Most natural areas have been reduced dramatically from their former extent; so remaining representative examples of each different type of ecological community are valuable.

There has been a move away from protection of only rare species and their habitats to protecting ecosystems that are good examples of the landscape character. Protection of substantial parts of ecosystems is usually needed to assure the survival of their constituent parts, such as individual species.

It is easy to ignore or place less importance on elements of ecosystem functioning, which are not obvious. Many evaluations are based on visual assessment e.g. a comparison of pasture to mature forest. But there are many other important elements of ecosystem integrity that are not so readily apparent; including water cycle, chemical factors, energy flow and biotic interactions.

4.2.3 Rarity and naturalness

It is easy to underestimate the value of rare species. Rarity is an indicator of the scarcity of numbers of a species or other element of biodiversity. The presence of a rare or special or unusual feature in a natural area adds to its ecological value. Rare species reflect the highest degree of ecosystem complexity and function and are the most sensitive to impact. Unfortunately, their rarity makes them impractical for use with most assessment studies done as part of development projects.

Naturalness is important to the survival of species, communities and other components of biodiversity, many of which will not survive outside a natural environment. Naturalness in ecosystems is inversely proportional to the degree of disturbance by humans or introduced species (e.g. weeds).

4.2.4 Diversity and pattern

A fundamental aim of nature conservation is to protect natural biological diversity. The diversity of a natural area refers to the species of plants and animals present as well as its communities, ecosystems, and physical features. Generally the ecological value of a natural area increases with its diversity and the complexity of its ecological patterns.

Wetlands, floodplains, and mature forests are key resources in sustainable design because they are generally the oldest and least disturbed site resources. Ecosystem function increases over time.

Long-term ecological viability is the ability of natural areas to retain their inherent natural values over time. This includes the ability of a natural area to resist disturbance and other adverse effects and for its component plant and animal species to regenerate and reproduce successfully.

Complex ecosystems often have a messy or “wild” appearance to them as their complexity increases. A mature forest can take hundreds of years to develop so seeing one indicates a lack of recent disturbance.

4.2.5 Size and shape

Size and shape of the area affect the long-term viability of a natural area's ecological components and functions. With increase in size, the diversity and resistance to disturbance of an area generally increases. The shape of a natural area influences its resistance to external effects (e.g. a compact shaped area is less vulnerable to edge effects than a complex one).

Ecosystem function increases, as the size of the natural area gets larger. The inverse is also true that ecosystem function is reduced when roads and urban development fragment natural systems. But small fragments and patches of native vegetation are still important and may be the only remnants left of a certain type in an area. They may provide habitat for relict population, or rare species may provide seed source for local revegetation. The smaller an area of bush is, the greater the edge effects, the lack of microclimates for certain species, and the more likely weed invasion will be.

Much of the Bay of Plenty urban areas were originally covered by forest prior to human settlement. This forest had maximum function due to its age, size and complexity. Human influence on the land has shrunk or eliminated this network of connected woodlands to a fraction of its former size.

The effect of area size on ecosystem function is, to some degree, a matter of geometry; the various dimensions of the tract change in proportion to the area of the tract. A tract reduced in area by a factor of one hundred reduces by one-tenth the distance to the centre of the tract and increases ten times the dominance of the perimeter habitat (edge/area ratio). Tract size has important implications for species that require interior habitat. The tract can become so small that the interior habitat and the species that depend on it are eliminated.

As discussed in Section 2, urbanisation causes a shift in the aquatic community from one dominated by pollution sensitive species towards one dominated by contaminant tolerant species. This ecological principle also applies to the terrestrial environment where the adverse impacts tend to be subtler in nature and more variable from site to site.

4.2.6 Hidden elements and scientific uncertainty

Obviously, we don't have all the answers. In LID, it is of great importance to consider the degree to which the landscape is permanently changed as a result of urban development. Safety factors are used in engineering to account for uncertainty and ensure that the "bridge doesn't collapse". This concept is even more applicable to natural resources that are considerably more complex and less well understood. Examples of safety factors that might be applicable to low-impact design might include the requirement for larger riparian buffer strips or native re-vegetation adjacent to existing indigenous forest.

Much of the Bay of Plenty region has had significant change to pre-colonisation conditions. Thus, urban development projects will have less overall impact than if widespread replacement of bush was done. The basic principles of ecology and landscape ecology still apply to minimise the impacts of future projects. Much of our knowledge of the functions and values of natural resources has developed in just the last 60 years. In a few years it is likely that we will look back on how little we knew now. While it can be seen that terrestrial ecology is important for protecting intrinsic values of a given area it is also critical that we do not lose sight of the major benefits that result from retention of these areas from a hydrological standpoint.

4.3 Wetlands

Wetlands, as defined in the Resource Management Act, include permanently or intermittently wet areas, shallow water, and land water margins that support a natural ecosystem of plants and animals that are adapted to wet conditions. They occur on land-water margins, or on land that is temporarily or permanently wet. Wetlands are a major habitat for at least eight species of indigenous freshwater fish as well as frogs, birds and invertebrates. Wetlands have unique hydrological characteristics that can be irreversibly modified by activities such as drainage.

Carmichael Constructed Wetland – Bethlehem Tauranga



There can be few other vegetation classes that have suffered so severely during human times than have wetlands. The reasons for this are many, but can be attributed largely to their position on flat land, suited to agriculture, and to the generally low esteem in which such vegetation has been held by the average layperson. These changes have occurred despite the manifest value of wetlands as wildlife habitats, as regulators of flooding, their intrinsic values, for recreation, and for scientific research. Nevertheless a far larger area than remains today has been lost through drainage, fire, topdressing and flooding.

The problem with wetlands is that they are rarely seen as being a valuable resource. They are usually difficult to access and therefore are rarely visited. Their wildlife is usually secretive and their plants are seldom spectacular or flamboyant. Their values as a source of mined material or as pastoral land or for horticulture are only realised after the wetland has been destroyed. Their ability to assist in water control is often only recognised after both floods and water shortages have occurred following their destruction.

Nationwide, freshwater wetlands covered at least 670,000 ha before European settlement, but have now been reduced by drainage for pasture to around 100,000 ha. Although several thousand wetlands still survive, most are very small and have been modified by human activities and invasive species. It is likely that some characteristic wetland types have been lost completely, while very few examples are left of others, such as kahikatea swamp forest and some kinds of flax swamp.

New Zealand's wetlands are as varied as the terrain that shapes them.

It is important to recognise that even without the presence of humans, wetland systems are modified and eliminated by a natural ecological ageing process referred to as succession. The filling and conversion of wetlands into more terrestrial type ecosystems occurs naturally at a relatively slow rate. The intervention of man into the process vastly accelerates the conversion process.

In their natural condition, wetlands provide many important functions to man and the environment. Table 4.1 summarises the major functions and values of wetlands.

Table 4.1 Summary of wetland functions and values.

Function/value	Description
Flood control	Attenuation of peak flows Storage of water Absorption by organic soils Infiltration to groundwater
Flow attenuation	Maintenance of stream flow during droughts
Erosion control	Increased channel friction Reduction in stream velocity Reduction in stream scour Channel stability by vegetative roots Dissipation of stream energy
Water quality maintenance	Sedimentation Burial of contaminants in sediments Adsorption of contaminants to solids Uptake by plants Aerobic decomposition by bacteria Anaerobic decomposition by bacteria
Habitat for wildlife	Food Shelter/protection from weather and predators Nursery area for early life stages
Fisheries habitat	Galaxids, eels, freshwater mussels, crayfish
Food chain support	Food production from sun (primary production)
Recreation/aesthetics	Enjoyment of nature Hiking, boating, bird watching
Education	Teaching, research

In addition to the listed beneficial values, the water quality benefits of wetlands can be expanded. Natural systems have complex mechanisms and the following listing of benefits describes the major processes occurring in wetlands that allow them to provide water quality enhancement functions. These functions include:

- Settling/burial in sediments;
- Uptake of contaminants in plant biomass;
- Filtration through vegetation;
- Adsorption on organic material;
- Bacterial decomposition;
- Temperature benefits; and
- Volatilisation.

4.4 Floodplains

Floodplains occupy those areas adjacent to stream channels that become inundated with stormwater during large rainfall/run-off events. For the most part, in the Bay of Plenty region, rainfall (in conjunction with inadequate drainage capacity) is the main cause of flooding although surges by wind driven currents can exacerbate the problem, or in unique situations, cause the flooding problem. Flooding problems result from two main components of precipitation: the intensity and duration of rainfall, and its areal extent and distribution.

Flooding has been the most common reason for declarations of civil defence emergency in New Zealand. In the 19th Century flood related drownings were dubbed “the New Zealand death”. Floods can occur in any season and in all regions of New Zealand. The rate of flooding increased 50-150 years ago, following widespread replacement of forests and scrub with shallow rooted pasture grasses. Despite extensive river and catchment control schemes, damage from flooding is estimated to cost at least \$125 million a year. Many studies have shown that paving and drainage systems in urban areas increase flooding, particularly as many urban areas are located along floodplains and former wetlands.

Flooding in and of itself is not a problem. Floods have been around since the beginning of time and are a natural part of the water cycle. Problems are caused when man interacts with the floodplain. Thus, flood hazard potential relating to human health, property damage, and social disruption are strongly influenced by human activity on the floodplain. There are several key catchment characteristics which impact on flood frequency and depths.

4.4.1 Catchment size and slope

The abundance of rainfall in the region feeds small first and second order streams. These streams and their associated floodplains are the conveyance means of getting water downstream, through the catchment, and to sea level. Smaller catchments have a rapid response time to storm flows where larger catchments have a longer response time as storm flows take time to travel through the drainage system.

4.4.2 Surface conditions and land use

Until the 19th Century, 75% of the country was covered in temperate rainforest. Replacing two-thirds of it with exotic grasses has dramatically increased the rate at which rain reaches the ground surface and flows overland into the stream system. Urbanisation, with its impervious surfaces has an even more profound effect on flood flows. Not only do flood flows increase in size and number, but also their speed of onset is increased, particularly in the first 20% of change from rural to impervious cover. This makes intensive, short-duration rainfalls more flood prone. In addition, time of year can impact on flood levels via intensity of rainfall and saturated condition of soils.

4.4.3 Floodplain topography

The channel form and associated floodplain in part determine the size of flood, particularly its depth and areal extent. A small catchment and wide floodplain will result in a shallow, but widespread flood. On the other hand, a deep channel and steep slopes will result in deeper flooding, but on a small area extent.

The many benefits that floodplains provide are partly a function of their size and lack of disturbance. But what makes them particularly valuable ecologically is their connection to water and the natural drainage systems of wetlands, streams, and estuaries. The water quality and water quantity functions provided by the floodplain overlap with the landscape functions of tract size and ecosystem complexity to make them exceptionally valuable natural resources.

Floodplains provide a wide range of benefits to both human and natural systems. These functions and values can be broadly placed in three categories; water resources, living resources and societal resources. Taking each of these individually provides the following:

4.4.4 Water resources

Floodplains provide for flood storage and conveyance during periods when flow exceeds channel boundaries. In their natural state they reduce flood velocities and peak flow rates by out of stream bank passage of stormwater through dense vegetation. They also promote sedimentation and filter contaminants from run-off. In addition, having a good shade cover for streams provides temperature moderation of stream flow. Maintaining natural floodplains will also promote infiltration and groundwater recharge, while increasing or maintaining the duration of stream base flow. Floodplains provide for the temporary storage of floodwaters. If floodplains were not protected, development would, through placement of structures and fill material in the floodplain, reduce their ability to store and convey stormwater when the need for floodplain storage occurs. This, in turn, would increase flood elevations upstream of the filled area and increase the velocity of water travelling past the reduced flow area. Either of these conditions could cause safety problems or cause significant damage to private property.

Table 4.2 provides values of roughness coefficients that have been established for floodplain areas for the purposes of hydraulic calculations to determine flow velocities and elevations. They indicate the value that vegetation has on the movement of flood flow and can be considered in the context of retardance factors. The higher the roughness value is, the greater the retardance to flow movement through it.

Table 4.2 Values of the roughness coefficient in floodplains.

Type of ground cover		Normal n
(a)	Pasture, no brush	
1	Short grass	0.030
2	High grass	0.035
(b)	Cultivated areas	
1	No crop	0.030
2	Mature row crops	0.035
3	Mature field crops	0.040
(c)	Brush	
1	Scattered brush, heavy weeds	0.050
2	Light brush and trees	0.060
3	Light brush and trees	0.100
(d)	Trees	
1	Heavy stand of timber, little undergrowth	0.100
2	Heavy stand of timber, flood stage in branches	0.120

As can clearly be seen, the denser and taller the vegetation, the greater the frictional resistance to stream flow.

4.4.5 Living resources

Natural floodplains are fertile and support a high rate of plant growth, which supports and maintains biological diversity. They provide breeding and feeding grounds for fish and wildlife. In addition, they provide habitat for rare and endangered species.

Ground cover in natural wetlands tends to be composed of leaf and dense organic matter. Organic soils have a lower density and higher water holding capacity than do mineral soils. This is due to the high porosity of organic soils or the percentage of pore spaces. This porosity allows floodplain soils generally to store more water than mineral soils would in upland areas.

4.4.6 Societal resources

Floodplains provide areas for active and passive recreational use. They increase open space areas and provide aesthetic pleasure. They also contain cultural and archaeological resources and provide opportunities for environmental and other studies. Human development historically has occurred around waterways for food and transportation. Many walkways exist in reserves and those walkways tend to be adjacent to stream channels.

4.5 Riparian buffers

Although reduction of contaminants is a generally recognised function of riparian buffers, they also contribute significantly to other aspects of water quality and physical habitat. Habitat alteration, especially channel straightening and removal of riparian vegetation, continues to impair the ecological health of streams more often and for longer time periods than contaminants.

When considering riparian buffers, it is helpful to detail the variety of benefits that are gained by their protection or implementation. Riparian buffer systems provide the following benefits:

4.5.1 Temperature and light

The daily and seasonal patterns of water temperature are critical habitat features that directly and indirectly affect the ability of a given stream to maintain viable populations of most aquatic species. Considerable evidence shows that the absence of riparian cover along many streams has a profound effect on the distribution of many species of macro-invertebrates and fish.

In the absence of shading by a forest canopy, direct sunlight can increase stream temperatures significantly (up to 12°C), especially during periods of low stream flow in summer. Riparian buffers have been shown to prevent the disruption of natural temperature patterns as well as to mitigate the increases in temperature following upstream deforestation.

Stream riparian buffer as a component of subdivision land use



4.5.2 Habitat diversity and channel morphology

The biological diversity of streams depends on the diversity of habitats available. Woody debris is one of the major factors in habitat diversity. Woody debris can benefit a stream by:

- Stabilising the stream environment by reducing the severity of the erosive influence of stream flow;
- Increasing the diversity and amount of habitat for aquatic organisms;
- Providing a source of organic carbon; and
- Forming debris dams and slowing stream velocities.

Loss of the riparian zone can lead to loss of habitat through stream widening where no permanent vegetation replaces forest, or through stream narrowing where forest is replaced by grass. In the absence of perennial vegetation, bank erosion and channel straightening can occur. The accelerated stream flow velocity allowed by straight channels promotes channel incision as erosion of sediment from the stream bottom exceeds the sediment load entering the stream. This process can eventually lead to the development of wide, shallow streams that support fewer species.

4.5.3 Food webs and species diversity

The two primary sources of natural food energy input to streams are litter fall from streamside vegetation and algal production within the stream. Total annual food energy inputs are similar under shaded and open canopies but the presence or absence of a tree canopy has a major influence on the balance between litter input and primary production of algae in the stream.

Having a stream exposed to sunlight for most of the day promotes algal growth and promotes proliferation of algal grazing species. This proliferation reduces species diversity. The diversity of the macro invertebrate community in a stream protected by a riparian buffer has a much greater diversity than does a stream not having a riparian canopy. This diversity is important in that it is in such a small area that goes from low land wetter soil conditions to upland fairly rapidly and thus promoting very different vegetative types. Also, riparian buffer areas are adjacent to streams and therefore floodplains. By periodic out of bank flow, floodplains are depositional zones for fertile sediments.

4.5.4 Contaminant removal

Riparian vegetation removes, sequesters, or transforms nutrients, sediments, and other contaminants. The removal function depends on two key factors:

- The capability of a particular area to intercept surface and/or groundwater borne contaminants; and
- The activity of specific contaminant removal processes (filtration, adsorption, biological uptake, etc.).

New Zealand studies have shown that the majority of nitrate removal in a pasture catchment takes place in the organic riparian soils, which receive large amounts of nitrate laden groundwater. The location of the high organic soils at the base of gullies caused a high proportion of groundwater to flow through the organic soils although they occupied only 12% of the riparian zone area.

Sediment trapping in riparian forest buffers is facilitated by physical interception of surface run-off that causes flow to slow and sediment particles to be deposited. Channelised flow is not conducive to sediment deposition and can, having higher velocities, cause erosion in the riparian buffer. From a sediment deposition perspective, the following main processes occur:

- The forest edge fosters large amounts of coarse sediment deposition within a few metres of the field/forest boundary;
- Finer sediments are deposited further into the forest; and
- The reverse occurs during out of bank stream flow where sediments carried from upstream in the catchment are deposited in the riparian buffer. The lowest velocities are at the outer edge of the buffer and the finer sediments are deposited there.

4.5.5 Importance to wildlife

- The greater availability of water to plants, frequently in combination with deeper soils, increases plant production and provides a suitable site for plants that would not occur in areas with inadequate water. This increases plant diversity.
- The shape of many riparian areas, particularly their linear meandering nature along streams, provides a great deal of productive edge.
- Riparian areas frequently produce more edge within a small area. In addition, along streams there are many layers of vegetation exposed in stair step structure. This structure provides diverse nesting and feeding opportunities for wildlife.
- Riparian areas along intermittent and perennial streams provide travel routes for wildlife.
- Although vulnerable to negative edge effects, such as weeds, riparian vegetation maintains habitat required for life cycle completion by riparian species and many instream species.
- Usually riparian margins are the remnants of more extensive natural areas, which is something to build upon for restoration.

4.5.6 Channel stability and flood flow protection

Streams are dynamic systems that are characterised by change. Instream stability and streambank erosion at a given point are heavily influenced by the land use and condition in the upstream catchment. However, vegetation is essential for stabilising stream banks, especially woody vegetation. Forested buffer strips have an indirect effect on streambank stability by providing deep root systems that hold the soil in place more effectively than grasses, and by providing a degree of roughness capable of slowing run-off velocities and spreading flows during large storm events. While slowing flood velocities may increase flood elevations upstream and in the buffer, downstream flood crest and damage may be significantly reduced. These processes are also critical for building floodplain soils.

4.6 **Vegetation cover**

New Zealand's vegetation cover has changed considerably in the past 700+ years, with the most dramatic changes occurring in the past century. Before human settlement, the region had a covering of native podocarp/broadleaf, beech forests with some grasslands. Māori cleared some forest for cultivation and hunting, and later European settlement had a greater impact as forests were felled for timber and pasture, and exotic animals and plants were introduced.

There are some significant areas in the region that have native vegetation. Forests have a number of components whose characteristics determine its effectiveness in terms of water quantity and quality. These characteristics include:

4.6.1 **Stormwater run-off reduction**

Woody vegetation and forest floor litter have a significant impact on the total volume of rainfall converted to run-off. Run-off volumes from forested areas are much less than volumes from other land uses. This lesser volume in run-off acts to minimise downstream erosion and instability problems.

4.6.2 **Soil structure**

Forest soils are generally regarded as effective nutrient traps. In New Zealand, most nutrients are retained (and recycled) in the leaf litter and shallow soil layers. Roots are usually quite shallow. The ability of a forest soil to function in removing nutrients in surface and groundwater is partially dependent on soil depth, ground slope, density of vegetation, permeability, extent and duration of shallow water table, and its function as a groundwater discharge zone.

4.6.3 **Organic litter layer**

The organic litter layer in a forest buffer provides a physical barrier to sediment movement, maintains surface porosity and higher infiltration rates, increased populations of soil mycorrhizae (a symbiotic relationship of plant roots and the mycellium of fungi - aids in decomposition of litter and translocation of nutrients from the soil into the root tissue), and provides a rich source of carbon essential for denitrification. The organic soil provides a reservoir for storage of nutrients to be later converted to woody biomass. A mature forest can absorb as much as 14 times more water than an equivalent area of grass. The absorptive ability of the forest floor develops and improves over time. Trees release stored moisture to the atmosphere through transpiration while soluble nutrients are used for growth.

4.6.4 **Forested areas**

Trees have several advantages over other vegetation in improving water quality. They aggressively convert nutrients into biomass. They are not easily smothered by sediment deposition or inundation during periods of high water level. Their spreading root mats resist gullyng and stimulate biological and chemical soil processes. They produce high amounts of carbon needed as an energy source for bacteria involved in the denitrification process. A forest's effectiveness in pollution control will vary with the age, structural attributes and species diversity of its trees, shrubs and understory vegetation.

To consider the involvement of a forested area in water quality treatment, there are a number of functions that define that performance. These functions can be broadly defined as physical and biological functions and include the following:

- Sediment filtering

The forest floor is composed of decaying leaves, twigs and branches, which form highly permeable layers of organic material. Large pore spaces in these layers catch, absorb, and store large volumes of water. Flow of stormwater through the forest is slowed down by the many obstructions encountered. Suspended sediment is further removed as run-off flows into the vegetation and litter of the forest floor. This sediment is readily incorporated into the forest soil. With a well-developed litter layer, infiltration capacities of forest soils generally exceed rainfall and can also absorb overland flows from adjacent lands.

- Nutrient removal

Forest ecosystems serve as filters, sinks and transformers of suspended and dissolved nutrients. The forest retains or removes nutrients by rapid incorporation and long-term storage in biomass, improvement of soil nutrient holding capacity by adding organic matter to the soil, reduction in leaching of dissolved nutrients in subsurface flow from uplands by evapotranspiration, bacterial denitrification in soils and groundwater, and prevention from erosion during heavy rains.

4.7 Soils

The region has a wide variety of soils predominantly in the following categories:

- Allophanic soils;
- Podzol soils;
- Grey soils;
- Granular soils;
- Organic soils;
- Pumice soils;
- Raw soils;
- Ultic soils;
- Brown soils; and
- Recent soils.

These soils have significant variability in fertility, permeability, density and parent material so careful attention has to be given to specific site soils when considering development and stormwater management.

4.7.1 Biological factors influencing soil development

Soils possess several outstanding characteristics as a medium for life. It is relatively stable structurally and chemically. The underground climate is far less variable than above-surface conditions. The atmosphere remains saturated or nearly so, until soil moisture drops below a critical point. Soil affords a refuge from high and low extremes in temperature, wind, evaporation, light and dryness. These conditions allow soil fauna to make easy adjustments to the development of unfavourable conditions. On the other hand, soil hampers movement. Except for organisms such as worms, space is important. It determines living space, humidity and gases.

A wide diversity of life is found in the soil as shown in Figure 4.1. The number of species of bacteria, fungi, protists, and representatives of nearly every invertebrate phylum found in soil is enormous. It has been estimated that approximately 50% of the earth's biodiversity occurs in soil. Dominant among the soil organisms are bacteria, fungi, protozoans and nematodes.

Figure 4.1 – Soil life forms

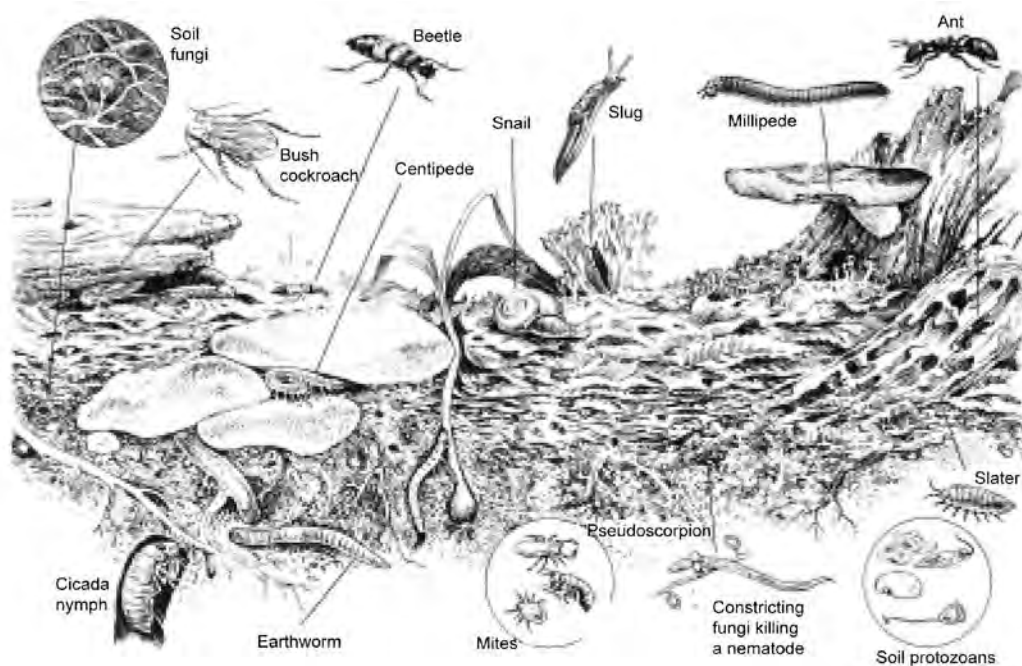

Prominent among the larger soil fauna are earthworms. Earthworm activity consists of burrowing through the soil. Burrowing involves ingestion of soil, the ingestion and partial digestion of fresh litter, and the subsequent egestion of both mixed with intestinal secretions. Egested matter is defecated as aggregated castings on or near the surface of the soil or as a semiliquid in intersoil spaces along the burrow. These aggregates produce a more open structure in heavy soil and bind light soil together. In this manner, earthworms improve the soil environment for other soil organisms by creating larger pore spaces and by mixing organic matter with the mineral soil.

Biological processes in soil development are the most complex soil forming factors. Lichens secrete organic acids that dissolve rock surfaces and successions of plants add nitrogen from the atmosphere. Dead roots, stems and leaves decompose and the products are absorbed back into the soil.

The vegetative community also has a very strong impact on soil development. The microclimate of a forest is very different from that of grassland. Tree roots penetrate further into the ground than do grass roots and bring up minerals from deeper areas and thus incorporate them into the organic layer.

The total amount of soil organic material depends not only upon vegetation, but also upon topographic and climatic influences. Peat formation can occur in basin situations where the water table is high. High levels of organic matter are also found in soils in cool, wet climates.

4.8 Slopes/topography

The presence of shallow root depths does not resist slope slippage on steeper slopes. Soil slippage is also directly related to the steepness of the slope, the type of soil and the underlying geology. Without deeper-rooted plants holding a slope, in situations where native vegetation has been replaced by grassed lawn, slopes in excess of 33% (18°) may start to creep. Slopes greater than 45% (24°) may see the onset of mass movement. In the case of Onerahi Chaos Breccia (Northland Allochthon where the soils are highly sheared and crushed variably calcareous and siliceous mudstones prone to slippage), slopes as flat as 1:8 can be unstable. Due to the shallow nature of the soils, most movement tends to occur in the first 1.5 m. Leaving native vegetation on these steeper slope areas is very important to maintain slope stability.

Recent studies in New Zealand have assessed the susceptibility of different vegetation types to landslides during rainstorms. In a study north of Gisborne landslide densities were 16 times greater under pasture than indigenous forest and four times greater under pasture than regenerating scrub. A survey of storm damage in tertiary sandstone/siltstone hill country reported that landslides in pasture were three to four times greater than in indigenous forest. Finally, in a detailed study of the relationship between slope morphology, regolith depth, and landslide incidence in eastern Taranaki hill country, identified a 10 times increase in erosion rate for modal slopes of 28-32° following deforestation.

4.9 Other natural features

There are other natural conditions that exist on sites beyond those discussed to this point. Those discussed earlier are the primary ones in terms of overall importance but there are others and consideration of their importance is in order.

4.9.1 Depression storage

Of the rainfall that strikes roofs, roads, pathways and pervious surfaces, some is trapped in the many shallow depressions of varying size and depth present on practically all ground surfaces. The specific magnitude of depression storage varies from site to site. Depression storage commonly ranges from 3 to 19 mm for flat areas and from 12 to 30 mm on grasslands of forests. Significant depression storage can also exist on moderate or gentle slopes with some estimation for pervious surfaces being between 6 to 12 mm of water and even more on forestland. Typical depths on moderate slopes can be 1 to 2 mm for impervious surfaces, 2 to 4 mm for lawns, 4 mm for pastures and 6 mm for forest litter. Steeper slopes would obviously have smaller values.

When using traditional hydrologic procedures, depression storage is contained in an initial abstraction term. The term includes all losses before run-off begins. It includes water that is ponded, retained by vegetation, evaporation, and infiltration. It is highly variable, but generally is correlated with soil and cover parameters.

Prior to urbanisation, catchments have a significant depressional storage factor. Passing through agricultural or wooded areas after significant rainfall clearly demonstrates the existence of depressional storage. The urbanisation process generally reduces that storage in addition to significantly modifying the land's surface. The combination of site compaction, site imperviousness and reduced depression storage causes dramatic increases in downstream flood potential and channel erosion.

Information from the Mahurangi Catchment north of Auckland indicates that long-term average annual predicted run-off varied from less than 300 mm (18% of rainfall) to greater than 600 mm (greater than 35% of rainfall). The 300 mm coincided with sub-catchments under permanent forest cover. The 600 mm coincided with sub-catchments in predominantly pastoral land use and on low infiltration soils. There is a clear statement in these statistics that significant volume reductions in run-off exist in forested catchments as opposed to volumes of run-off from pastoral land cover.

4.9.2 **Natural drainage systems**

Natural site drainage features exist on every site. The most common of these features is having an existing flow path for stormwater run-off. Water doesn't travel down a hill in a straight line. Straight lines are something that humans have developed to accelerate the passage of water downstream as quickly as possible. During site development, the tendency is to place water in conveyance systems, open and enclosed, which follow the shortest distance to site outfalls.

Shortening the flow distance effectively increases the slope that water travels on, accelerates the flow of water, and increases the ability of water to scour downstream receiving systems. When water travels over a meandering flow path, energy is dissipated, which reduces the erosion potential. Shortening flow lengths reduces energy expended and increases the available erosion producing energy. Stream channels will meander regardless of the degree of human alteration. Replicating existing flow paths and lengths, to the extent possible, promotes channel stability and increases function and value.

The additional functions provided by meandering channels over straight channels are also simply related to the length of the aquatic resource and the time that the water is in contact with the various biotic and abiotic processing mechanisms. The additional length of meandering channels provides a greater total quantity of aquatic resource, and the associated functions and values they provide.

4.9.3 **Uncompacted vegetated areas**

A common approach to site development is to clear most, if not all, of the site being developed. Existing vegetated areas of the site are often cleared even when in non-essential locations. Clearing and grading of areas that will remain pervious results in significant compaction of those areas. This compaction reduces expected infiltration rates and increases overland flow.

A key issue with respect to urban development is the issue of significant soil compaction. The activity of heavy earth moving equipment on a construction site causes significant compaction of soils whose surface is designed to remain pervious. Landcare Research (Zanders, 2001) did some investigation on urban soils and found that earthworks had a significant adverse effect on water flow through soils after cut and fill operations were conducted. The earthworks allowed virtually no percolation of water through Horizon 2 soil profile.

There are three options to address this concern:

- 1 Where cuts or fills of at least 1 m are intended to facilitate site development, the expected permeability of the soil may be reduced. Stormwater management calculations that detail post construction hydrology should use a modified approach to soil classifications.
- 2 In areas of significant site disturbance, and where there is less than 1 m of cut or fill, soil classifications are not modified, but consents should contain a construction requirement that significantly disturbed soils in areas where those soils remain pervious should be chisel ploughed. Chisel ploughing will break the surface crust of the disturbed soil and allow for a greater infiltration rate. This would then provide a good foundation for the placement of topsoil and prevent slippage of the topsoil when on slopes that become saturated.
- 3 Keep equipment out of areas preserved for open space.

4.10 **Linkage with site development**

The only way that site development can occur in a manner that integrates existing site resources is to identify those site resources present on the site prior to initiation of site design. The first step in site resource integration is in conducting an inventory of site resources and detailing them on a plan. A simple checklist can be developed which is based on the items presented here. The checklist could include the following items, which have been discussed throughout the Section.

- Wetlands;
- Floodplains;
- Riparian buffers;
- Vegetative cover;
- Soils;
- Steep slopes; and
- Other natural features.

A checklist should also include:

- Archaeological sites; and
- Cultural sites.

This plan should be included as a part of the Stormwater Management Plan submitted to BOPRC. A narrative should also be submitted to detail what steps have been considered and/or provided to integrate existing resources into the Stormwater Management Plan.

Plan designers and developers should also be aware of territorial authority specific criteria, which may overlap, or conflict with the natural site features items listed above.

4.11 **Natural mechanisms for stormwater pollution removal**

Although many stormwater related contaminants can be reduced if not eliminated through preventive design approaches driven by water quantity reduction objectives, not all contaminants can be eliminated. In such situations, an array of natural pollutant removal processes is available for use and should be exploited to the maximum. Because these processes tend to be associated with, even reliant upon, both vegetation and soil processes, they can be readily incorporated into other low impact design approaches. Such natural contaminant reduction/elimination processes include:

4.11.1 **Settling/deposition**

The kinetic energy of stormwater washes all types of matter, particulate form and other, from land cover surfaces. Particulates remain suspended in stormwater flows as long as the energy level is maintained. Heavier particulates require more kinetic energy in order to remain in suspension. As the energy level declines - as the storm flow slows, these suspended particulates begin to settle out by gravity, with larger, heavier particulates settling out most quickly and the smallest colloidal particulates requiring considerably more time for settling. To the extent that time can be maximised, more settling can be expected to occur, holding all other factors constant. Therefore, approaches which delay stormwater movement or approaches which reduce kinetic energy in some manner (e.g. energy dissipaters) serve to maximise settling and deposition.

4.11.2 **Filtering**

Another natural process is physical filtration. As contaminants pass through the surface vegetative layer and then down through the soil, larger particulates are physically filtered from stormwater. Vegetation on the surface ranging from grass to underbrush removes larger contaminant particulates. Stormwater sheet flow through a relatively narrow natural riparian buffer of trees and undergrowth has been demonstrated to physically filter surprisingly large proportions of larger particulates. Both filter strips and grass swales rely very much on this filtration process. Filtration may also occur as stormwater infiltrates into the topsoil strata.

4.11.3 **Biological transformation and uptake/utilisation**

Although grouped as one type, this category includes a complex array of different processes that reflect the remarkable complexity of different vegetative types, their varying root systems, and their different needs and rates of uptake of different contaminants. An equally vast and complex community of microorganisms exists within the soil mantle, and though more micro in scale, the myriad of natural processes occurring within this realm is just as remarkable. Certainly both phosphorus and nitrogen are essential to plant growth and therefore are taken up typically through the root systems of the various vegetative types, from grass to trees.

4.11.4 Chemical processes

For stormwater which has infiltrated into the soil mantle and then moves toward groundwater aquifers, various chemical processes also occur within the soil. Important processes occurring include adsorption through ion exchange and chemical precipitation. Cation Exchange Capacity (CEC) is a rating given to soil, which relates to a particular soil's ability to remove contaminants as stormwater enters the soil mantle (through the process of adsorption). Adsorption will increase as the total surface area of soil particles increases; this surface area increases as soil particles become smaller, as soil becomes tighter and denser (clay has more surface area per unit volume than does sand).

Low-impact design techniques offer an array of natural processes and techniques that substantially increase contaminant removal potential above and beyond mitigation being provided by many of the structural stormwater practices. Through a combination of vegetative-linked removal combined with using soils on a site, contaminants entrained in stormwater run-off are removed and in some cases eliminated. In this way, contaminants are prevented from making their way into either surface or groundwaters. The various design details are discussed later in this guideline.

4.12 Bibliography

- Chesapeake Bay Program, Chesapeake Bay Riparian Handbook: A Guide for Establishing and Maintaining Riparian Forest Buffers, edited by Palone and Todd, May, 1997.
- Collier, K.J., Cooper, Davies-Colley, Rutherford, Smith, Williamson, Managing Riparian Zones: A Contribution to Protecting New Zealand's Rivers and Streams, Volume 2: Guidelines, NIWA, Department of Conservation, July, 1995.
- Environmental Council of New Zealand, Wetlands A Diminishing Resources, Report for the Minister for the Environment, February, 1983.
- Ericksen, N.J., Creating Flood Disasters? New Zealand's need for a new approach to urban flood hazard, Water & Soil Miscellaneous Publication No. 77, Wellington, 1986.
- Molloy, Les, Soils in the New Zealand Landscape, The Living Mantle, Mallinson Rendel Publishers Ltd., 1988.
- Myers S. et al. A Guidebook for the Rapid Ecological Survey of Natural Areas, New Zealand Biological Resources Centre Publication No. 6, Department of Conservation, 1987.
- Myers, S., Wetlands in the Auckland Region, Auckland Regional Council, 1997.
- Quinn, J.M., Cooper, A.B., Williamson, R.B., Riparian Zones as Buffer Strips: A New Zealand Perspective, NIWA, 1993.
- Shaver, E., Maxted, J., Construction of Wetlands for Stormwater Treatment, 1993.
- Smith, R.L., Ecology and Field Biology Fifth Edition, Harper Collins College Publishers, 1996.
- Zanders, J., Urban Development and Soils, Soil Horizons Newsletter, Landcare Research, Issue 6, November 2001.

Part 5: Stormwater management concepts

5.1 Background

When considering the RMA, every person has a duty to avoid, remedy or mitigate any adverse effect on the environment arising from an activity. It also should be recognised that avoidance or remedy are much more cost effective options than mitigation. Those three duties can be defined as the following:

5.1.1 Avoid

This includes practices that prevent stormwater becoming contaminated in the first place. Examples include the following:

- Use of building or safety materials or paints that do not leach contaminants; or
- Picking an approach to development that has fewer adverse environmental effects; or
- Reducing the amount of impervious surface that is constructed; or
- New products that do not contain materials that, when wearing down, discharge contaminants.

The implementation of LID is the most appropriate avoidance principle that can be considered. LID reduces adverse environmental effects and reduces the amount of impervious surface that is constructed.

5.1.2 Remedy

In a similar fashion to avoidance, preventing practices or locations that generate contaminants from coming into contact with stormwater can remedy an existing problem.

Practices that remedy problems are practices, such as street sweeping, that have been implemented in urban areas to reduce constituent loadings in stormwater run-off, thereby reducing the need for more expensive structural practices. In a study of stormwater characteristics for various land uses in the city of Austin (City of Austin, 1990)

constituent median event mean concentrations (EMCs) were reduced in areas where street sweeping occurred at least once per week, versus those areas that did not receive maintenance. The important element here is the frequency of sweeping. Reducing the frequency of sweeping reduces the contaminant reduction benefits.

Examples of remedial actions could include the following:

- Road and storm drain maintenance practices such as street sweeping (using high efficiency regenerative sweepers) and catch pit cleaning;
- Controls on illegal dumping;

Poor engine tuning increasing contamination



- Landscaping practices that reduce or eliminate the use of fertilisers and pesticides;
- Storage practices for potential contaminants;
- Fleet vehicle maintenance programmes;
- Covering of contaminant generation areas on industrial sites; and
- Reduce, reuse or recycling programmes.

While avoiding a problem is much easier when consideration is given prior to construction being done, subsequent maintenance by substitution of products or by developing an environmental management plan for maintenance activities also can reduce or eliminate a contaminant problem. Individual actions, when taken in conjunction with other actions, can reduce contaminant loadings over time.

5.1.3 Mitigate

Mitigation has been the historical approach to reducing stormwater contaminants downstream. Mitigation involves the construction of stormwater treatment practices to reduce the quantity of stormwater and the level of contaminants in stormwater run-off.

The purpose of this guideline is to provide design guidance for stormwater management practices and thus it primarily is a mitigation guideline for stormwater effects. Any one practice, on its own, is unlikely to achieve the stormwater management objectives for a given project. For this reason it is necessary to consider the objectives early in the design process when competing demands can be carefully balanced and an integrated solution achieved. The need for, and size of, treatment devices is then minimised, as is their installation and maintenance costs. The combination of a number of different tools or practices to achieve an overall stormwater objective is normally referred to as a “treatment train”.

Stormwater management on new projects will mostly fall in the mitigation category until low-impact design principals are promoted and adopted and require stormwater management practices to reduce downstream contaminant levels.

Example of treatment train of mitigation practices on one site to reduce contaminant discharge



5.2 Stormwater treatment processes

Stormwater treatment practices attempt a difficult task; the removal of contaminants entrained in stormwater flows. Significant proportions of contaminants are dissolved in stormwater, and many others are attached to fine particles of silt and clay, which do not easily settle. Processes that reduce contaminant levels include the following:

- Sedimentation;
- Aerobic and anaerobic decomposition;
- Filtration and adsorption to filter material;

- Biological uptake;
- Biofiltration; and
- Flocculation.

These processes will be discussed individually in the following subsections.

5.2.1 Sedimentation

Most stormwater management programmes in New Zealand and internationally started initially with an intention to mitigate the effects of excess sedimentation into streams and estuaries. The logic was that capture of sediment, while being beneficial, would also provide capture of other contaminants that are attached to the sediments. The following tables and figure provide discussion of sediment particle size, contaminants associated with various sized particles, fall velocities for various sediment particle sizes and lastly a representation of how particle size determines whether they can be removed by sedimentation.

The first table, Table 5.1 provides a listing of various particle classes and their sizes (Chow, 1964).

Table 5.1 Particle characteristics.

Size		Class
Millimetres	Microns	
64-32		Very coarse gravel
32-16		Coarse gravel
16-8		Medium gravel
8-4		Fine gravel
4-2		Very fine gravel
2-1	2,000-1,000	Very coarse sand
1-0.5	1,000-500	Coarse sand
0.5-0.25	500-250	Medium sand
0.25-0.125	250-125	Fine sand
0.125-0.062	125-62	Very fine sand
	62-31	Coarse silt
	31-16	Medium silt
	16-8	Fine silt
	8-4	Very fine silt
	4-2	Coarse clay
	2-1	Medium clay
	1-0.5	Fine clay
	0.5-0.24	Very fine clay

Sediment coarser than medium silt settles rapidly, but much longer settling times are required for finer particles to settle. Particles less than 10 µm tend not to settle discretely according to Stokes Law (1851), but exhibit flocculent settling characteristics. Particle shape, density, water viscosity, electrostatic forces, and flow characteristics affect settling rates.

Stokes Law $V_s = 2/9(r^2g(p_p - p_f)/\eta)$

- Where: V_s = settling velocity (m/s)
 R = particle radius (m)
 G = standard gravity (m/s)
 p_p = particle density (kg/m³)
 p_f = fluid density (kg/m³)
 η = fluid viscosity (pascal-second (pa-s))

Table 5.2 discusses particle size and contaminants associated with them in general stormwater run-off (Ding et al, 1999).

Table 5.2 Metals distribution and particle sizes.

Particle Size (µm)	Metals distribution (%)							
	Cd	Co	Cr	Cu	Mn	Ni	Pb	Zn
<10	46	60	71	63	71	63	73	60
10-100	36	31	24	30	21	29	23	35
>100	18	9	5	7	8	8	4	5

As can be seen, significant portions of the contaminant loads are attached to finer sediments. It should be noted that there is variation of the above table by various researchers and better information should be obtained before definitive statements are made. The important point is the trend, which indicates that metals tend to be associated with fine sediments.

Table 5.3 shows particle settling velocities based on Auckland data (Semadeni-Davies, 2006) and includes the proportion of particles in each size category.

Table 5.3 Particle size versus settling velocity.

Particle diameter (µm)	Proportion of particles (%)	Cumulative proportion (%)	Particle density (kg/m ³)	Settling velocity (m/h)
3	5	5	1,100	0.002
6	8	13	1,300	0.021
10	5	18	1,600	0.118
15	6	24	1,900	0.397
20	5	29	1,900	0.706
25	4	33	1,900	1.102
30	3	36	2,150	2.028
50	12	48	2,300	6.366
75	19	67	2,500	16.524
100	12	79	2,650	32.31
150	15	94	2,650	67.732
200	5	99	2,650	94.086
300	1	100	2,650	149.517

It should be noted that actual settling velocities in the field are often significantly lower than the theoretical values, especially for finer particles. This can be due to turbulence but can also be due to a reduction in settling velocities that occurs the more particles are present. The greater the concentration of suspended sediments, the less the settling velocity can be. Measurements of reductions in settling velocities of 50% and greater have been recorded in high sediment laden water when compared to the same soil particle sizes in clear water. This is not a major factor in permanent stormwater practices but would be a consideration for sediment control ponds.

Figure 5-1 shows sediment particle diameter with the ability to remove various particle sizes with sedimentation (Minton, 2002).

Figure 5.1 - Particle size and general classification

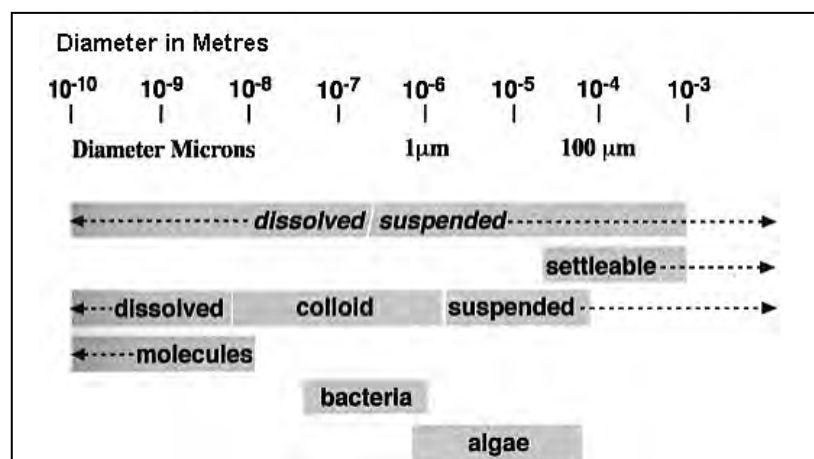

As can be seen from the above tables and figure, the ability to use sedimentation as a means of contaminant reduction is limited to larger particle sizes. Depending on the contaminants of concern, removal of suspended solids by sedimentation alone may not remove the contaminants of greatest concern. It is important to identify the contaminants of greatest concern in order to determine what processes can remove a given contaminant.

Removal of nutrients by sedimentation is not very effective as nitrogen tends to be in a soluble form while phosphorus may be dissolved or attached to sediments. Sedimentation can remove moderate levels of phosphorus but have negligible effect on nitrogen.

5.2.2 Aerobic and anaerobic decomposition

Another process by which contaminants are removed is by microorganisms reducing soluble BOD (Biological Oxygen Demand) and breaking down nutrients and organic compounds by aerobic and anaerobic decomposition. The primary practice that uses aerobic and anaerobic decomposition is wetlands.

Once the aerobic microorganisms have taken up contaminants they die and settle to the bottom of ponds where further anaerobic oxidation may take place. In anaerobic conditions, microorganisms can remove nitrogen by de-nitrification. This is an important process in constructed wetland function. Figure 5-2 (Kadlec, Knight, 1996) shows a simplified wetland nitrogen cycle.

This process is important when considering areas where nutrient enrichment of receiving systems (primarily lakes) is a problem.

Denitrification is a reduction process where electrons are added to nitrate or nitrite nitrogen, resulting in the production of nitrogen gas, nitrous oxide (N_2O) or nitric oxide (NO). This can only occur when dissolved or free nitrogen is absent. In other words there has to be an anaerobic layer at the bottom of the wetland for denitrification to occur. Anaerobic processes are an important mechanism for nitrogen removal. Nutrient removal in wetlands is not only due to uptake by flourishing plant growth, but also to physical processes such as the adsorption of nutrients to sediments, precipitation and sedimentation. Plants and sediments are the major accumulators of nutrients in wetlands. Some nutrients such as nitrogen compounds may be converted to nitrogen gas and return to the atmosphere due to the creation of an anaerobic environment.

Periodic harvesting of plants may stimulate further plant growth and this may, in turn, enhance further nutrient removal.

Figure 5.2 - Wetland process for denitrification

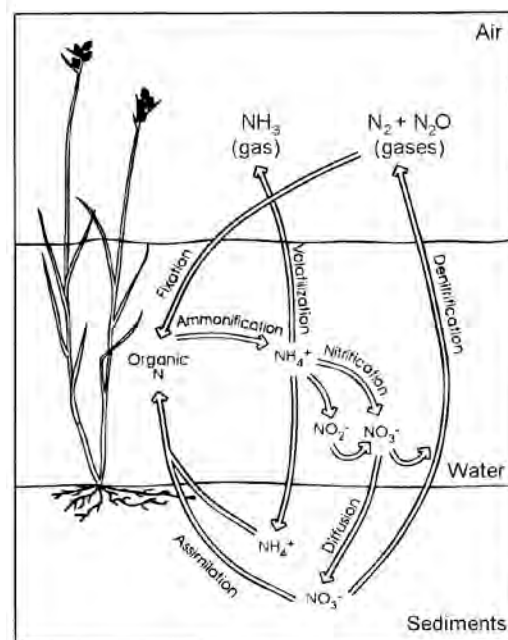

Having an anaerobic layer develop in a wetland can have other less desirable effects as water can become acidic and mobilise contaminants already captured. If nutrients are not a concern in a given catchment and wetlands are proposed due to their enhanced ability to capture dissolved metals, it is important to maintain an aerobic environment to prevent remobilisation.

5.2.3 Filtration and adsorption to filter material

As sediment particles pass through a filter bed or through soil, the following filtration processes may remove them:

- Settling into crevices;
- Enmeshment (entangling) in interstices; and
- Impingement onto filter particles followed by sticking onto particles (by electrostatic or other bonding).

Filtration has been used for years in wastewater treatment to remove solids from liquids. In the late 1980's filtration was being applied to stormwater treatment, primarily for sediments and oils and grease removal. It functions by interposing a medium to fluid flow through which the fluid can pass, but the solids in the fluid are retained. Its function is determined by the pore size, the thickness of the medium and the live storage elevation above the medium, which drives the fluid through the medium. The path for the fluid to pass through the medium is tortuous and particles are unable to move through the medium.

Adsorption is the accumulation of dissolved substances on the surface of a media such as plants or filters. Dissolved substances can also be removed by adsorption to filter material and biological uptake by microorganisms living among the filter material.

Adsorption is a process that occurs when a liquid solute accumulates on the surface of a solid or forms a film on the surface. It is different from absorption where the substance diffuses into the solid. Atoms of the clean surface experience a bond deficiency and it is favourable for them to bond with whatever happens to be available. Adsorption is a key removal mechanism for dissolved metal reduction in stormwater run-off.

5.2.4 Biological uptake

Wetlands and bio-retention areas use the interaction of the chemical, physical, and biological processes between soils and water to filter out sediments and constituents from stormwater. They also use interaction of plants to enhance the treatment process. Constituents are first absorbed, filtered and transformed by the soil and then taken up by the plant roots. Table 5.4 provides some discussion of contaminant uptake by vegetation (Kadlac, Knight, 1996).

Sand filtration practice at a petrol station, recently maintained



Swale providing biological uptake of nutrients



Table 5.4 Ability of biota to uptake contaminants.

Nitrogen	Nitrogen reduction by plants is extremely complicated and depends on the form of nitrogen, pH, growing season, climate, etc. Most of the information available relates to performance of wetland plants with little information on nitrogen uptake by biofiltration systems. Organic nitrogen compounds are a significant fraction of the dry weight of plants.
Phosphorus	Plants require phosphorus for growth and incorporate it in their tissue. The most rapid uptake is by microbiota (bacteria, fungi, algae, etc.) because they grow and multiply at high rates. Phosphorus is a nutrient and its addition stimulates growth.
Metals	Metals reach plants via their fine root structure, and most are intercepted there. Some small amounts may find their way to stems, leaves and rhizomes. Upon root death, some fraction of the metal content may be permanently buried, but there is no data on metal release during root decomposition.

Plants do take up nutrients or metals from stormwater via absorption processes. However they may also re-release them to the water column when they die and decay. An example of this is a swale that is periodically mowed. Unless the grass cuttings are physically removed from the catchment, they will eventually decompose and the contaminants (primarily nutrients) will again be available for transport downstream.

Biological uptake is a less important process in swales, filter strips and rain gardens than it is in wetlands where, for nutrients, it can be an important process.

5.2.5 Biofiltration

A variation to the filtration mechanism is to use plants as the filter media. Biofiltration is a contaminant control technique using living material to capture and biologically degrade and process contaminants. Contaminants adhere to plant surfaces or are absorbed into vegetation. This mechanism is a combination of filtering, reduced settling time and adhesion.

An example of biofiltration is a swale or rain garden where the combination of soils and vegetation provide natural biofiltration. Rain gardens operate by filtering run-off through a soil media prior to discharge into a drainage system. The major contaminant removal pathways are (Somes, Nicholas and Crosby, Joe, 2007):

- Event processes:
 - Sedimentation in the extended detention storage, primary sediments and metals;
 - Filtration by the filter media, fine sediments and colloidal particles; and
 - Nutrient uptake by biofilms.
- Inter-event processes:
 - Nutrient adsorption and contaminant decomposition by soil bacteria; and
 - Adsorption of metals and nutrients by filter particles.

Rain garden servicing a bus depot



The major issues with performance of biofiltration as a contaminant reduction practice is maintenance of low flow velocities and hydraulic loading during storms too large to permit sedimentation of silts and clays, even with dense vegetation (Mazer, Booth, and Ewing, 2001).

5.2.6 Flocculation

Flocculation is a process of contact and adhesion whereby the particles of a dispersive medium form larger size particles, which then settle to the bottom of a liquid. Clay particles are colloidal particles that have electrostatic surface charges. In general, most colloidal material has a negative charge. Particles with like charges tend to repel each other, preventing the forming of coagulated particles. These characteristics cause the colloidal particles to remain in solution. Destabilising colloidal material to allow coagulation and settlement to occur is achieved by adding reagents that develop positive charges. Positively charged ions in the solution act to destabilise the colloidal matter and allow settlement of coagulated material to occur.

Flocculation occurs after the addition of chemical to destabilise the charges on the colloidal particles in suspension. The particles adhere to each other via the flocculant ions on the surface of the particles. These charged ions provide an opportunity for charged particles in a system to adhere to them, thereby merging individual particles (Figure 5.3). This results in larger, denser flocs that settle more rapidly (ARC, 2003).

Figure 5.3 - Process of coagulation of colloids due to ion exchange

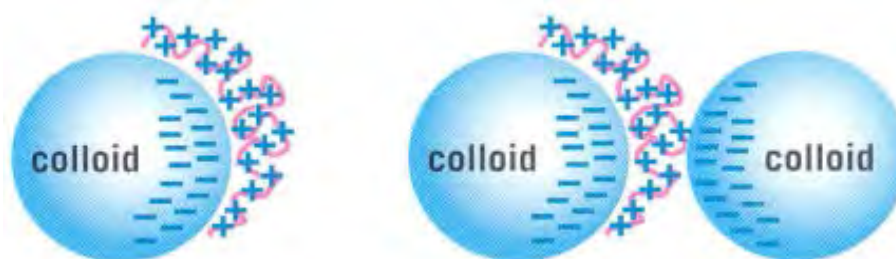

The Auckland Regional Council and the New Zealand Transport Agency have been using flocculation for approximately seven years on sediment control ponds to improve performance at removal of clay particles. Monitoring to date has indicated enhanced sediment removal performance using polyacrylamide, alum and polyaluminium chloride (PAC). For a number of reasons use has gravitated to PAC as the flocculant of choice.

There has been some experimentation with flocculation in New Zealand for lake phosphorus control but that has been done on a trial basis and not implemented long term (Environment BOP, 2004). It has been used overseas, primarily using alum in lakes for nutrient and macrophyte control. Results have been generally positive but there have been indications of potentially toxic concentrations of aluminium with dosing (Carr, 1999). In addition, the issues of collection and disposal of flocculated sediments is an issue that needs better direction and understanding (Harper, Harvey, H., undated).

5.3 Bibliography

- City of Austin, Stormwater Pollutant Loading Characteristics for Various Land Uses in the Austin Area, Environmental Resources Management Division, Environmental and Conservation Services Department, City of Austin, Austin Texas, 1990.
- Ven Te Chow, Editor -in- Chief, Handbook of Applied Hydrology: A Compendium of Water-resources Technology, McGraw-Hill Book Company, 1964.
- Ding, Y, Dresnack, R., Chan, P.C., Assessment of High-Rate Sedimentation Processes: Microcarrier Weighted Coagulation Jar Tests, Prepared for the U.S. EPA, contract number 7C-R364-NAFX, New Jersey, U.S.A., 1999.
- Kadlec, R.H., Knight, R.L., Treatment Wetlands, CRC Press, Inc., Lewis Publishers, 1996.
- Semadeni-Davies, Annette, Fall Velocities of Stormwater Sediment Particles, prepared for Auckland Regional Council, December 2006.
- Minton, Gary, Stormwater Treatment: Biological, Chemical and Engineering Principles, Printed and bound by Amica International Inc. 2002.
- Mazer, G., Booth, D., Ewing, K., Limitations to Vegetation Establishment and Growth in Biofiltration Swales, Ecological Engineering, Volume 17, Issue 4, pages 429-443, August 2001.
- Somes, Nicholas and Crosby, Joe, Review of Street Scale WSUD in Melbourne Study Findings, Kingston City Council and the Better Bays and Waterways Institutionalising Water Sensitive Design and Best Management Practice Project, January 2007 (revised).
- Auckland Regional Council, Flocculation Guidelines: Technical Publication 90, Auckland Regional Council, 2003.
- Carr, David, W., An Assessment of an In-Line Alum Injection Facility used to Treat Stormwater Run-off in Pinellas County, Florida, Sixth Biennial Stormwater Research & Watershed Management Conference, September 1999.
- McIntosh, John, Assessment of Nutrient Reduction Treatments (Forest Research and URS), Report to the Regulation & Monitoring Committee, Meeting of 23 November 2004.
- Harper, Harvey, H., Current Research and Trends in Alum Treatment of Stormwater Run-off, Environmental Research & Design, Inc., undated.

Part 6: Choosing a stormwater management device

6.1 Introduction

Stormwater management practices are asked to provide water quantity control, water quality control or sometimes both. It is important to recognise that stormwater management practices do not perform equally and in all situations. A practice using infiltration of run-off as the method of choice is not going to function in soils that do not allow passage of water through it due to limited permeability rates. In the same regard, a practice such as a stormwater management pond may be good at removal of suspended solids but provide little benefit for dissolved metals reduction.

It is important to recognise the potential effectiveness of different stormwater practices on the contaminants generated at a specific site and for a given receiving environment. Consideration should be given to contaminants of concern and stormwater management practices appropriate to remove those contaminants.

6.2 Site considerations

The success of any management practice depends on selecting the appropriate options for the sites control objectives and conditions at an early stage. The objectives must be clearly defined at the outset and site conditions investigated in enough detail to match the practice to the site so as to meet the objectives. Decisions need to be made whether quantity control, quality control or ecosystem protection or enhancement are required and which contaminants need to be treated and how.

Deciding whether a practice is relevant means looking at the following issues:

- Soils in the location of the intended stormwater management practice;
- Slopes;
- Catchment area draining to individual practices; and
- General constraints.

The following sections discuss each of these items in more detail.

6.2.1 Soils

Underlying soils are very important to determine whether a given stormwater management practice will function as intended. More permeable soils can enhance the operation of some practices, but adversely affect the performance of others. As an example, a constructed wetland may not retain water if the underlying soils are sandy. Figure 6.1 provides a map of major soil types in the BOPRC Region. A larger version of the map is available on the BOPRC website:

www.envbop.govt.nz/RegionMap/BOPRegionMap.htm

For a number of practices, having soil of a given permeability may not present fatal problems. If a constructed wetland were intended for a given site that has sandy soils, a clay or geotextile liner would prevent infiltration of water and maintain a normal pool level.

Figure 6.1 - Soils of the Bay of Plenty region

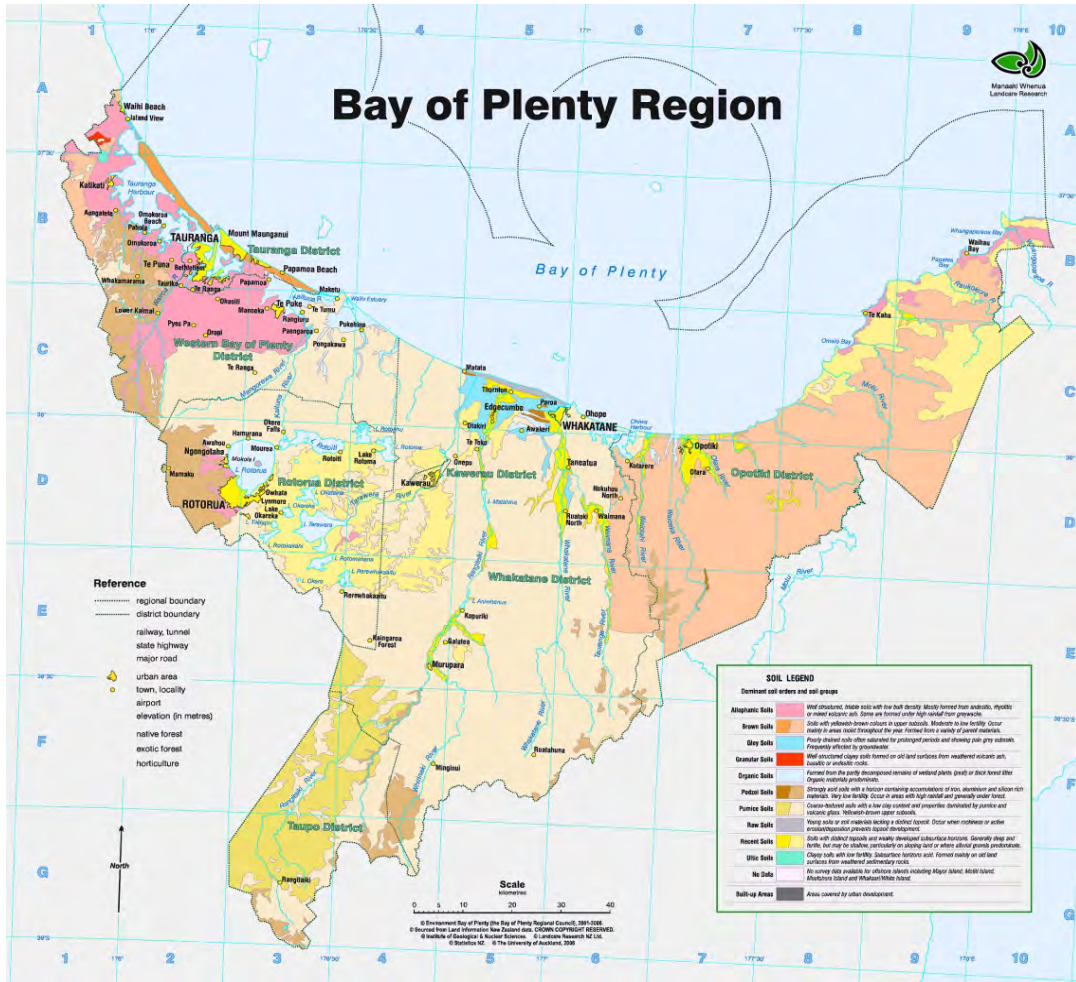

On the other hand infiltration practices rely on passage of water through the soil profile, and more permeable soils transmit greater volumes of water. Having poor permeability in subsoils would preclude the use of infiltration practices for a given area. From a general context, the following Table 6.1 provides a discussion of various soils and their approximate infiltration rate.

Table 6.1 Infiltration rate for various soil textural classes.

Texture class	Approximate infiltration rate in mm/hour
Sand	210
Loamy sand	61
Sandy loam	26
Loam	13
Silt loam	7
Sandy clay loam	4.5
Clay loam	2.5
Silty clay loam	1.5
Sandy clay	1.3
Silty clay	1.0
Clay	0.5

The location of the red line in the table indicates a normal minimum permeability limit for when infiltration practices are suitable for a given site. If the infiltration tests indicate an infiltration rate of less than 7 mm/hr then infiltration is not normally considered as an appropriate practice.

Table 6.2 provides a view of practices and their suitability for various soil textures.

Table 6.2 Soil and suitability of various stormwater management practices.

Ponds/wetlands				
Sand filters				
Rain gardens				
Infiltration				
Swales/filter strips				
	Sand	Loam	Silty	Clay
<i>Blue colour denotes acceptable practice range related to soil types.</i>				

To some people there is confusion over what a loam soil is. Loam is soil that is composed of sand, silt and clay in relatively even concentration (approximately 40-40-20% respectively). Loam soil contains the right amount of sand, silt, clay and organic material. It is known as a “garden soil” that is good for plants. They generally contain more nutrients than does sandy soils. Silty loam is generally considered as the soil having the minimum permeability rates for use of infiltration practices. Loamy soil is also commonly recommended for use in rain gardens.

6.2.2 Slopes

Slope is important when selecting a stormwater management practice. Steeper slopes may:

- Eliminate some practices from consideration;
- Require practices to be modified from a more desired approach; or
- Have little impact on the use of others.

Stormwater management practices that rely on storage of water have slope limitations as adequate storage may necessitate significant cuts and fills to meet storage requirements. The adjacent simplified figure 5-1 (ARC, 2003) shows how slope steepness can impact on storage ability of a pond. The same analogy applies to filter systems that have a live storage requirement.

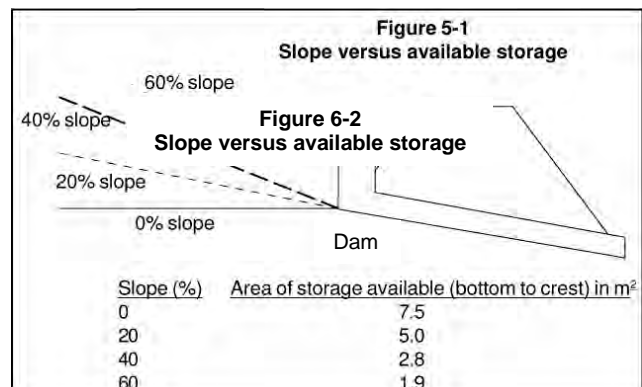

Other practices, such as vegetated swales may be adapted for steeper slopes if the swales are placed along the contours, rather than up or down slopes. The ability to manipulate direction of swales is limited and slope may well determine whether swales or filter strips can be used on a given project. Swales and filter strips are normally limited to approximately a 5% slope to ensure that adequate residence time will be provided for significant contaminant reduction and to ensure that flow velocities don't cause erosion.

The following Table 6.3 provides some discussion of stormwater management practices and their limitations related to slope.

Table 6.3 Slope limitations of various stormwater management practices.

Practice	Slope limitation
Ponds/wetlands	As the slope increases the amount of cuts and/or fills increases. Ponds generally are not suitable on slopes >10%.
Sand filters	Sand filters can either be pre-fabricated units or constructed in place. For prefabricated units, generally live storage can be provided within the unit so slope is not a critical issue. For open systems, the slope problems are similar to ponds or rain gardens.
Rain gardens	Similarly to ponds, live storage is a problem on steeper slopes. The surface of the rain garden has to be level to ensure an even flow through the media.
Infiltration	Infiltration practices are not recommended on steeper slopes or on fill slopes. There is a potential for slope instability with seepage coming out on the slope below the practice or for lateral flow to occur at the natural ground/fill interface. Infiltration should only be used when a geotechnical engineer certifies it as an appropriate use.
Swales/filter strips	Not suitable for slopes >5% unless check dams flatten overall slope.

6.2.3 Catchment area

Catchment area is another key element that determines the suitability of a stormwater management practice at a specific site. Some practices, due to treatment or hydrological factors are more appropriate to smaller or larger catchment areas. Practices that rely on vegetative or filter media filtering of run-off are more appropriate for smaller catchment areas, as large flows may overwhelm their ability to filter the run-off. Ponds, on the other hand, are more appropriate for larger catchment areas. (ARC, 2003). The following Table 6.4 provides guidance for stormwater management practices and catchment areas that they are suitable for.

Table 6.4 Stormwater management practices related to catchment areas.

Stormwater management practice											Controlling factor for use
Ponds											Catchment area to maintain normal pool of water
Wetlands											Catchment area to maintain hydric soils
Sand filters											Volume of run-off
Rain gardens											Volume of run-off
Infiltration											Soils, slope, stability, etc.
Swales and filter strips											Rate of run-off and slope
	0	2	4	6	8	10	12	14	20	40	(in hectares)
	■ Suitable for use		■ Marginal for use								

6.2.4 General constraints

There are a number of other constraints that may limit a given practice from being used on a specific site. Those items can include, but not be limited to, the following issues:

- High groundwater table and potential mounding;
- Proximity to bedrock;
- Slope stability;
- Space availability;
- Maximum depth limits;
- High sediment input;
- Thermal effects; and
- Cost.

Each of these issues is discussed in the following subsections.

6.3 High groundwater table and potential mounding

Having a high groundwater table can preclude the use of a number of practices. Figure 6.2 (Department of Natural Resources, 1984) shows a typical schematic of ground surface and groundwater level. Seasonally there can be a wide variation in groundwater levels and that difference can be in excess of a metre depending on the time of year.

Figure 6.2 - Groundwater schematic

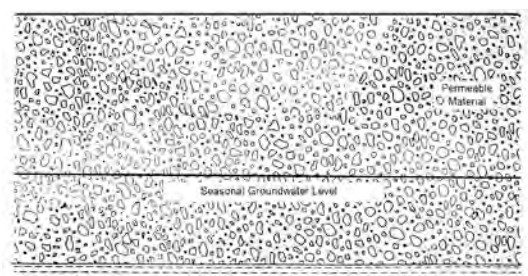

Practices that need to be cognisant of groundwater levels in terms of their location and applicability include:

- Ponds, both deeper and wetlands;
- Infiltration practices; and
- Swales.

Filter systems can generally be designed around site conditions as long as there is a positive outfall.

Groundwater mounding can also be a concern. This is particularly true for infiltration practices, where significant surface run-off is concentrated in one area, soaks into the ground and then elevates local groundwater levels as shown in Figure 6.3. Even though predevelopment groundwater levels may be low enough that problems shouldn't result, the artificial raising of local groundwater levels could cause performance problems.

Figure 6.3 - Groundwater mounding under an infiltration practice

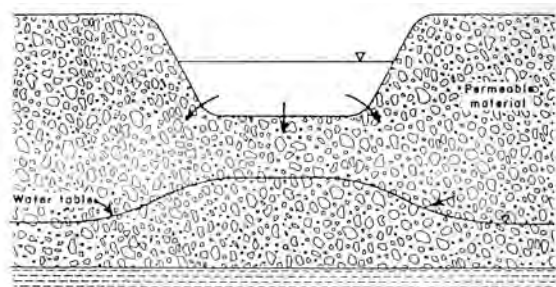

6.3.1 Proximity to bedrock

Proximity to bedrock has two major issues: drainage in a similar fashion that infiltration practices have with groundwater levels, and cost to construct a practice whose invert requires excavation in bedrock. Either of these two issues could fatally impact on use of a given practice and it could apply to any practice depending on the depth to bedrock.

6.3.2 Slope stability

Having a practice on a slope could increase instability issues related to the slope. Practices that discharge to ground on a slope could have that discharge exit the slope above the toe of the slope, as shown in Figure 6.4 (figure by author), and increase saturation of the slope or have overland flow across the slope where it did not exist prior to development. This could apply to infiltration practices primarily but could also apply to rain gardens and swales if they discharge to the top of a steep slope.

Figure 6.4 - Slope and seepage from an infiltration trench

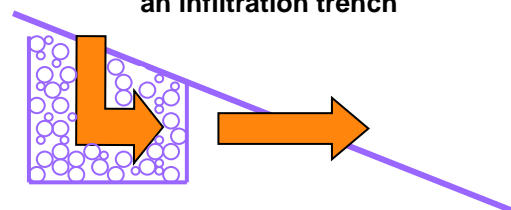

If local stability codes are considered from around the country, a uniform requirement relates to consideration of springs and groundwater conditions. The Greater Wellington Regional Council has a Landslide Hazard Fact Sheet (undated) with one heading being "Too Much Water". The text states, "A small amount of rain dampens the soil and helps particles stick to each other. Too much rain can cause the soil particles to lose contact with each other. Then the heavy waterlogged soil starts to move. Small surface slips after rainstorms are common in the Wellington region". Using a practice on a slope that may not have existing stability issues and then artificially putting water in the soil could cause stability concerns. Geotechnical reports should be done if there is an intention to place stormwater flows in the ground on slopes.

6.3.3 Space availability

In general, space allocated for stormwater management is always going to be limited. There may be situations where regulatory requirements and downstream impacts may necessitate acquiring additional land but, for the most part, practices will have to fit within a given limited site area that is available for stormwater management practices.

From a water quantity perspective there may be opportunities to be creative, such as under sizing pipes conveying catchment drainage and using road embankments to control water quantity discharges downstream. Water quality will still need to be provided for the highway itself, as catchment flows would necessitate large treatment practices.

Those practices having the greatest area requirements are ponds and wetlands. These practices are generally more appropriate for larger catchments (as detailed in the catchment discussion in Section 5.2.3) and larger footprints.

6.3.4 Maximum depth limits

There will be situations, especially where there are reticulation systems, when the invert of the receiving system pipe will determine the invert of the stormwater management practice. If the invert of the receiving pipe is above the invert of the stormwater management practice then the practice won't drain and could cause localised flooding or system bypass.

There has to be a positive outfall from stormwater management practices if they are to function for peak control or water quality treatment.

6.4 High sediment inputs

A number of stormwater management practices are sensitive to excess sediment loadings and will incur maintenance problems if catchment sediment loads draining to the individual practice are high. Examples of this situation would be areas adjacent to a treatment practice undergoing earthworks and having high sediment loads entering the treatment system. Another situation could involve horticultural activities where seasonal land clearing and planting could increase sediment run-off to treatment practices.

Prematurely clogged rain garden from unstabilised adjacent areas



Practices that are sensitive to high sediment loadings that will have a fairly rapid decline in water quality treatment performance include the following:

- Infiltration practices;
- Sand filters;
- Rain gardens;
- Swales; and
- Filter strips.

Ponds and wetlands, having sediment forebays, have the ability to store larger sediment loads than the other practices, although they still would require more frequent maintenance to maintain performance.

6.4.1 Thermal effects

Water temperature affects water chemistry and quality, and has a pervasive, over-riding influence on the biota through its control of enzyme systems and the physiology of cold-blooded animals. Water temperature is therefore a key factor influencing the ecological performance of streams. Summer is the main problem time for stream temperatures.

Pavement modifies stormwater temperatures, raising it during the summer, but cooling it in cold winter months. A study done in the U.S. (Black, 1980) observed during one summer storm that the temperature of the stormwater from a parking lot was 5°C higher than the rainwater.

From a New Zealand context, acute mortality for most native New Zealand fauna tested to date occurred above 25°C. LT₅₀ values (lethal temperatures that killed 50% of the test organisms over a 10 minute duration) for nine species of native fish ranged from 27.0-31.9°C (Richardson *et. al*, 1994). Juvenile and adult eels were considerably more tolerant than other fish species (LT₅₀ ranges from 34.8-39.7°C), and thus were not used in setting assessment criteria. Native invertebrate species were more sensitive than fish, where LT₅₀ values (24-hour exposure) for 12 species ranged from 25.9-32.4°C (Quinn *et. al*, 1994). Simons (1986) recommended that a maximum value of 3°C below the lowest LT₅₀ would allow for a margin of safety. Based upon the test data and interpretations, slight, moderate and severe adverse effects were estimated to occur above 22°C, 24°C and 26°C respectively.

There are two possible sources of temperature increase from urban land uses: impervious surfaces and stormwater management ponds. Temperature increases from pavements were mentioned above but stormwater ponds could increase thermal loadings to receiving systems. Ponds may have degraded water quality due to temperature increases, as their surface area tends to be exposed to direct sunlight and heat up. They could cause significant adverse effects on downstream macroinvertebrate communities (Maxted *et. al*, 2005). There are ways to reduce those impacts including if the ponds:

- Are not located in stream channels;
- Have below surface outfalls (temperatures are greatest at the surface); and
- Are small enough that riparian vegetation could provide shading of the pond surface.

Thermal impacts from wetlands are reduced from those caused by ponds due to increased surface area coverage by wetlands vegetation.

Other stormwater management practices may mitigate the effects of impervious surface temperature increases by moderating temperature as the water passes through the practice.

6.4.2 Cost

Stormwater management costs can relate to several factors including:

- Property acquisition;
- Practice construction; and
- Whole of life costs relating to subsequent operational expenses.

All of these factors can, and should, enter into decisions regarding practice selection and implementation. Costs may be difficult to predict on a nationwide basis depending on regulatory requirements from various consenting authorities, and site acquisition costs will be highly variable.

Landcare Research is developing a whole-of-life costing model for a number of stormwater management practices. It is very preliminary at this time (2010) but it should provide good value on stormwater cost considerations when it is completed.

An example of highway expected costs comes from the State of Washington (Hoey and Girts, 2000) where the Washington State Department of Transportation estimates \$7 million/year for maintenance of stormwater practices and capital costs ranging from 8-20% of total project costs depending on project type and location.

Experience by this author of stormwater management practices over the years has indicated operational costs would approximate 5% of construction costs on an annual basis to ensure adequate funding for maintenance activities. There will be years where that funding is not completely used but there will be other years where significant maintenance is required, which averages the long-term costs out.

One element of costs that may not normally be considered is the benefits of stormwater management relating to the following:

- Flooding and property damage;
- Degradation of water quality;
- Loss of fish and wildlife habitat; and
- Loss of marine habitat.

Ward and Scrimgeour (1991) utilised a non-market valuation technique to quantify some of the valued aspects of Auckland's marine environment. They considered that the total benefits derived, based on the level of water quality at that time, were estimated to be \$442 million (in 1991 dollars) per annum. In addition, scenarios were considered to calculate future benefits and losses as a result of deterioration in water quality. This work was only an estimation of values associated with the marine environment and excluded freshwater environmental values and the avoided property and safety implications of flooding events in developed areas. While this was only one study it is indicative that there are financial benefits to implementation of stormwater management.

6.5 Contaminant generation

Addressing contaminants should be done on the basis of the receiving system and the potential contaminants generated by the activity. For years, most stormwater management programmes were focused towards removal of suspended solids, but that may not be appropriate for activity-derived contaminants or for various receiving systems. When looking at contaminant generation potential, New Zealand data is similar to water quality data collected overseas.

In terms of practice selection, New Zealand data indicates that as with overseas studies, lead is the least soluble of the key elements in stormwater (<10%) with zinc being the most soluble (about 40%). Cadmium and copper appear to be moderately soluble with about 30% in the soluble phase. If zinc is a concern on a given project, practices that rely on sedimentation will not be effective at total zinc removal. If lead were a specific concern, sedimentation would be an effective approach.

The Auckland Regional Council has developed a contaminant load model (ARC Version May 2006) that inputs the land use (source) that is generating the contaminant and then allows various stormwater management practices to be applied to determine contaminant discharge from a given area. The following Figure 6.5 shows the contaminant spread sheet, which can be downloaded from the ARC website at www.arc.govt.nz/fms/stormwater/contaminantLoadModelMAY06.xls.

The figure is not provided to view various inputs but rather to show the general appearance of the spread sheet. For roads, the contaminant model considers various vehicles/day and applies contaminant loads for that situation as shown in the following Table 6.5.

Figure 6.5 - Auckland Council load model excel spreadsheet

Contaminant Load Model
Version MAY06



SOURCE	Site area (m²)	Source contaminant management train				Contaminant yields, loads, and load reduction efficiencies																	
		Source Area (m²)	First management option	Second management option	Third management option	Fraction of area treated by train	Zinc				Copper				Total Petroleum Hydrocarbons								
							Yield (kg m⁻² yr⁻¹)	Load (kg yr⁻¹)	Reduction (%)	Retention (%)	Yield (kg m⁻² yr⁻¹)	Load (kg yr⁻¹)	Reduction (%)	Retention (%)	Yield (kg m⁻² yr⁻¹)	Load (kg yr⁻¹)	Reduction (%)	Retention (%)					
Roads	Government residential	4				4	0.10	0.40	0.05	0.10	0.01	0.01	0.01	0.01	0.01	0.01	0.01	0.01	0.01	0.01	0.01	0.01	0.01
	Government water (per user)	4				4	0.10	0.40	0.05	0.10	0.01	0.01	0.01	0.01	0.01	0.01	0.01	0.01	0.01	0.01	0.01	0.01	0.01
	Commercial open (per user)	4				4	0.10	0.40	0.05	0.10	0.01	0.01	0.01	0.01	0.01	0.01	0.01	0.01	0.01	0.01	0.01	0.01	0.01
	Commercial (per user)	4				4	0.10	0.40	0.05	0.10	0.01	0.01	0.01	0.01	0.01	0.01	0.01	0.01	0.01	0.01	0.01	0.01	0.01
	Commercial (per user)	4				4	0.10	0.40	0.05	0.10	0.01	0.01	0.01	0.01	0.01	0.01	0.01	0.01	0.01	0.01	0.01	0.01	0.01
	Commercial (per user)	4				4	0.10	0.40	0.05	0.10	0.01	0.01	0.01	0.01	0.01	0.01	0.01	0.01	0.01	0.01	0.01	0.01	0.01
	Commercial (per user)	4				4	0.10	0.40	0.05	0.10	0.01	0.01	0.01	0.01	0.01	0.01	0.01	0.01	0.01	0.01	0.01	0.01	0.01
	Commercial (per user)	4				4	0.10	0.40	0.05	0.10	0.01	0.01	0.01	0.01	0.01	0.01	0.01	0.01	0.01	0.01	0.01	0.01	0.01
	Commercial (per user)	4				4	0.10	0.40	0.05	0.10	0.01	0.01	0.01	0.01	0.01	0.01	0.01	0.01	0.01	0.01	0.01	0.01	0.01
	Commercial (per user)	4				4	0.10	0.40	0.05	0.10	0.01	0.01	0.01	0.01	0.01	0.01	0.01	0.01	0.01	0.01	0.01	0.01	0.01
Commercial (per user)	4				4	0.10	0.40	0.05	0.10	0.01	0.01	0.01	0.01	0.01	0.01	0.01	0.01	0.01	0.01	0.01	0.01	0.01	
Commercial (per user)	4				4	0.10	0.40	0.05	0.10	0.01	0.01	0.01	0.01	0.01	0.01	0.01	0.01	0.01	0.01	0.01	0.01	0.01	
Commercial (per user)	4				4	0.10	0.40	0.05	0.10	0.01	0.01	0.01	0.01	0.01	0.01	0.01	0.01	0.01	0.01	0.01	0.01	0.01	
Commercial (per user)	4				4	0.10	0.40	0.05	0.10	0.01	0.01	0.01	0.01	0.01	0.01	0.01	0.01	0.01	0.01	0.01	0.01	0.01	
Commercial (per user)	4				4	0.10	0.40	0.05	0.10	0.01	0.01	0.01	0.01	0.01	0.01	0.01	0.01	0.01	0.01	0.01	0.01	0.01	
Commercial (per user)	4				4	0.10	0.40	0.05	0.10	0.01	0.01	0.01	0.01	0.01	0.01	0.01	0.01	0.01	0.01	0.01	0.01	0.01	
Commercial (per user)	4				4	0.10	0.40	0.05	0.10	0.01	0.01	0.01	0.01	0.01	0.01	0.01	0.01	0.01	0.01	0.01	0.01	0.01	
Commercial (per user)	4				4	0.10	0.40	0.05	0.10	0.01	0.01	0.01	0.01	0.01	0.01	0.01	0.01	0.01	0.01	0.01	0.01	0.01	
Commercial (per user)	4				4	0.10	0.40	0.05	0.10	0.01	0.01	0.01	0.01	0.01	0.01	0.01	0.01	0.01	0.01	0.01	0.01	0.01	
Commercial (per user)	4				4	0.10	0.40	0.05	0.10	0.01	0.01	0.01	0.01	0.01	0.01	0.01	0.01	0.01	0.01	0.01	0.01	0.01	
Commercial (per user)	4				4	0.10	0.40	0.05	0.10	0.01	0.01	0.01	0.01	0.01	0.01	0.01	0.01	0.01	0.01	0.01	0.01	0.01	
Commercial (per user)	4				4	0.10	0.40	0.05	0.10	0.01	0.01	0.01	0.01	0.01	0.01	0.01	0.01	0.01	0.01	0.01	0.01	0.01	
Commercial (per user)	4				4	0.10	0.40	0.05	0.10	0.01	0.01	0.01	0.01	0.01	0.01	0.01	0.01	0.01	0.01	0.01	0.01	0.01	
Commercial (per user)	4				4	0.10	0.40	0.05	0.10	0.01	0.01	0.01	0.01	0.01	0.01	0.01	0.01	0.01	0.01	0.01	0.01	0.01	
Commercial (per user)	4				4	0.10	0.40	0.05	0.10	0.01	0.01	0.01	0.01	0.01	0.01	0.01	0.01	0.01	0.01	0.01	0.01	0.01	
Commercial (per user)	4				4	0.10	0.40	0.05	0.10	0.01	0.01	0.01	0.01	0.01	0.01	0.01	0.01	0.01	0.01	0.01	0.01	0.01	
Commercial (per user)	4				4	0.10	0.40	0.05	0.10	0.01	0.01	0.01	0.01	0.01	0.01	0.01	0.01	0.01	0.01	0.01	0.01	0.01	
Commercial (per user)	4				4	0.10	0.40	0.05	0.10	0.01	0.01	0.01	0.01	0.01	0.01	0.01	0.01	0.01	0.01	0.01	0.01	0.01	
Commercial (per user)	4				4	0.10	0.40	0.05	0.10	0.01	0.01	0.01	0.01	0.01	0.01	0.01	0.01	0.01	0.01	0.01	0.01	0.01	
Commercial (per user)	4				4	0.10	0.40	0.05	0.10	0.01	0.01	0.01	0.01	0.01	0.01	0.01	0.01	0.01	0.01	0.01	0.01	0.01	
Commercial (per user)	4				4	0.10	0.40	0.05	0.10	0.01	0.01	0.01	0.01	0.01	0.01	0.01	0.01	0.01	0.01	0.01	0.01	0.01	
Commercial (per user)	4				4	0.10	0.40	0.05	0.10	0.01	0.01	0.01	0.01	0.01	0.01	0.01	0.01	0.01	0.01	0.01	0.01	0.01	
Commercial (per user)	4				4	0.10	0.40	0.05	0.10	0.01	0.01	0.01	0.01	0.01	0.01	0.01	0.01	0.01	0.01	0.01	0.01	0.01	
Commercial (per user)	4				4	0.10	0.40	0.05	0.10	0.01	0.01	0.01	0.01	0.01	0.01	0.01	0.01	0.01	0.01	0.01	0.01	0.01	
Commercial (per user)	4				4	0.10	0.40	0.05	0.10	0.01	0.01	0.01	0.01	0.01	0.01	0.01	0.01	0.01	0.01	0.01	0.01	0.01	
Commercial (per user)	4				4	0.10	0.40	0.05	0.10	0.01	0.01	0.01	0.01	0.01	0.01	0.01	0.01	0.01	0.01	0.01	0.01	0.01	
Commercial (per user)	4				4	0.10	0.40	0.05	0.10	0.01	0.01	0.01	0.01	0.01	0.01	0.01	0.01	0.01	0.01	0.01	0.01	0.01	
Commercial (per user)	4				4	0.10	0.40	0.05	0.10	0.01	0.01	0.01	0.01	0.01	0.01	0.01	0.01	0.01	0.01	0.01	0.01	0.01	
Commercial (per user)	4				4	0.10	0.40	0.05	0.10	0.01	0.01	0.01	0.01	0.01	0.01	0.01	0.01	0.01	0.01	0.01	0.01	0.01	
Commercial (per user)	4				4	0.10	0.40	0.05	0.10	0.01	0.01	0.01	0.01	0.01	0.01	0.01	0.01	0.01	0.01	0.01	0.01	0.01	
Commercial (per user)	4				4	0.10	0.40	0.05	0.10	0.01	0.01	0.01	0.01	0.01	0.01	0.01	0.01	0.01	0.01	0.01	0.01	0.01	
Commercial (per user)	4				4	0.10	0.40	0.05	0.10	0.01	0.01	0.01	0.01	0.01	0.01	0.01	0.01	0.01	0.01	0.01	0.01	0.01	
Commercial (per user)	4				4	0.10	0.40	0.05	0.10	0.01	0.01	0.01	0.01	0.01	0.01	0.01	0.01	0.01	0.01	0.01	0.01	0.01	
Commercial (per user)	4				4	0.10	0.40	0.05	0.10	0.01	0.01	0.01	0.01	0.01	0.01	0.01	0.01	0.01	0.01	0.01	0.01	0.01	
Commercial (per user)	4				4	0.10	0.40	0.05	0.10	0.01	0.01	0.01	0.01	0.01	0.01	0.01	0.01	0.01	0.01	0.01	0.01	0.01	
Commercial (per user)	4				4	0.10	0.40	0.05	0.10	0.01	0.01	0.01	0.01	0.01	0.01	0.01	0.01	0.01	0.01	0.01	0.01	0.01	
Commercial (per user)	4				4	0.10	0.40	0.05	0.10	0.01	0.01	0.01	0.01	0.01	0.01	0.01	0.01	0.01	0.01	0.01	0.01	0.01	
Commercial (per user)	4				4	0.10	0.40	0.05	0.10	0.01	0.01	0.01	0.01	0.01	0.01	0.01	0.01	0.01	0.01	0.01	0.01	0.01	
Commercial (per user)	4				4	0.10	0.40	0.05	0.10	0.01	0.01	0.01	0.01	0.01	0.01	0.01	0.01	0.01	0.01	0.01	0.01	0.01	
Commercial (per user)	4				4	0.10	0.40	0.05	0.10	0.01	0.01	0.01	0.01	0.01	0.01	0.01	0.01	0.01	0.01	0.01	0.01	0.01	
Commercial (per user)	4				4	0.10	0.40	0.05	0.10	0.01	0.01	0.01	0.01	0.01	0.01	0.01	0.01	0.01	0.01	0.01	0.01	0.01	
Commercial (per user)	4				4	0.10	0.40	0.05	0.10	0.01	0.01	0.01	0.01	0.01	0.01	0.01	0.01	0.01	0.01	0.01	0.01	0.01	
Commercial (per user)	4				4	0.10	0.40	0.05	0.10	0.01	0.01	0.01	0.01</										

Table 6.5 Contaminant loads for various daily traffic counts.

Vehicles/day	Contaminant unit loadings for various contaminants			
	Sediment (g/m ² /yr)	Zinc (g/m ² /yr)	Copper (g/m ² /yr)	Total petroleum hydrocarbons (g/m ² /yr)
<1,000	4	0.021	0.0070	0.11
1,000-5,000	30	0.107	0.0349	0.54
5,000-20,000	150	0.537	0.1744	2.68
20,000-50,000	299	1.068	0.3472	5.34
50,000-100,000	300	2.281	0.7414	11.41
>100,000	300	3.532	1.1480	17.66

As can be seen, the contaminant loads increase geometrically rather than linearly. Very high traffic roadways can have a significant impact on contaminant delivery to a receiving system. The daily traffic count could very well determine whether stormwater management needs to be provided for a given highway. This information would also help to prioritise where stormwater treatment needs to be provided.

6.6 Contaminant removal processes

Once the contaminants of greatest concern are identified, it is important to understand the processes that may be used to reduce contaminant discharge downstream. The following Table 6.6 lists all of the principal mechanisms that can capture, hold and transform various classes of contaminants in stormwater run-off and the factors that promote the operation of each mechanism to improve water quality.

Table 6.6 Summary of contaminant removal mechanisms.

Mechanism	Contaminants affected	Removal promoted by
Physical sedimentation	Solids, BOD, pathogens, particulate COD, P, N, metals, synthetic organics	Low turbulence
Filtration	Same as sedimentation	Fine, dense herbaceous plants, constructed filters
Soil incorporation	All	Medium-fine texture
Chemical precipitation	Dissolved P, metals	High alkalinity
Adsorption	Dissolved P, metals, synthetic organics	High soil Al, Fe, high soil organics, neutral pH
Ion exchange	Dissolved metals	High soil cation exchange capacity
Oxidation	COD, petroleum hydrocarbons, synthetic organics	Aerobic conditions
Photolysis	Same as oxidation	High light
Volatilisation	Volatile petroleum hydrocarbons and synthetic organics	High temperature and air movement

Mechanism	Contaminants affected	Removal promoted by
Biological microbial decomposition	BOD, COD, petroleum hydrocarbons, synthetic organics	High plant surface area and soil organics
Plant uptake and metabolism	P, N, metals	High plant activity and surface area
Natural die-off	Pathogens	Plant excretions
Nitrification	NH ₃ -N	Dissolved oxygen >2 mg/l, low toxicants, temperature >5-7°C, neutral pH
Denitrification	NO ₃ + NO ₂ - N	Anaerobic, low toxicants, temperature >15°C

A key factor to consider in the functioning of all mechanisms is time. The effectiveness of settling a solid particle is directly related to the time provided to complete sedimentation at the particle's characteristic settling velocity (shown in Table 5.3). Time is also a crucial variable to determine the degree that chemical and biological mechanisms operate. Characteristic rates of chemical reactions and biologically mediated processes must be recognised to obtain treatment benefits. For all of these reasons, water residence time is the most basic variable to apply as an effective treatment practice technology.

The information in Table 6.6 can also be arranged by features that promote specific contaminant control objectives. The following features provide for most objectives.

- Features that assist in achieving any objective
 - Increasing hydraulic residence time
 - Low turbulence
 - Fine, dense herbaceous plants
 - Medium-fine textured soil
- Features that assist in achieving specific objectives
 - Phosphorus control
 - High soil exchangeable aluminium and/or iron content
 - Addition of precipitating agents
 - Nitrogen control
 - Alternating aerobic and anaerobic conditions
 - Low toxicants
 - Neutral pH
 - Metals control
- High soil organic content
 - High soil cation exchange capacity
 - Neutral pH

- Organic control
 - Aerobic conditions
 - High light
 - High soil organic content
 - Low toxicants
 - Neutral pH

6.7 Device selection

Section 9 provides detailed discussion on choosing and designing stormwater management practices. This subsection is providing a more generic discussion of practices and their ability to remove various contaminants and function for water quantity control. In a number of situations, stormwater management practices can provide both water quantity and water quality control for a given site. In other situations, this may not be possible and multiple practices may have to be used to achieve desired outcomes. The following Table 6.7 provides some discussion of various practices and their ability to address water quantity and water quality for various contaminants.

Table 6.7 Stormwater management practices and water quantity/quality control.

Practice	Water quantity peak control capability	Water quality capability			
		Sediment	Metals	TPH	Nutrients
Extended detention dry pond	High	Moderate	Pb - Moderate Cu - Low Zn - Low	Low	P - Low N - Low
Extended detention wet pond	High	High	Pb - High Cu - Moderate Zn - Moderate	Low	P - Moderate N - Low
Wet pond	High	High	Pb - High Cu - Moderate Zn - Moderate	Low	P - Moderate N - Low
Wetland	High	High	Pb - High Cu - High Zn - High	High	P - High N - High
Filter systems	Low	High	Pb - High Cu - Moderate Zn - Low	High	P - Moderate N - Low
Rain gardens	Low	High	Pb - High Cu - High Zn - High	High	P - High N - Moderate
Infiltration	Moderate	High	Pb - High Cu - High Zn - High	High	P - High N - Moderate
Swales and filter strips	Low	High	Pb - High Cu - Moderate Zn - Moderate	Mod	P - Moderate N - Low

As can be seen from Table 6.7, selection of a stormwater management practice or practices will depend on the contaminants of concern and whether peak discharge control is a requirement. Other than ponds and wetlands, water quality practices have limited peak flow control capability and must be used in conjunction with another practice if overall project control is to be achieved.

6.8 Treatment train approach

As mentioned briefly in the previous paragraph, water quality treatment practices have limited peak flow control capability and must be used in conjunction with a water quantity control practice if both issues (water quantity/water quality) are to be addressed. It may be difficult for one practice to provide for multiple benefits and increasingly, on an international basis, more emphasis is being placed on a stormwater “treatment train” approach to stormwater management where several different types of stormwater practices are used together and integrated into a comprehensive stormwater management system.

A treatment train approach ideally considers both source control and treatment as part of the overall approach. Figure 6.6 shows a schematic of a treatment train approach to stormwater management. Cleaning catch-pits, street vacuum sweeping, substitution of various less contaminating building materials would be the first car in the treatment train. Source control can have value and should be considered.

Figure 6.6 - Schematic of a treatment train approach

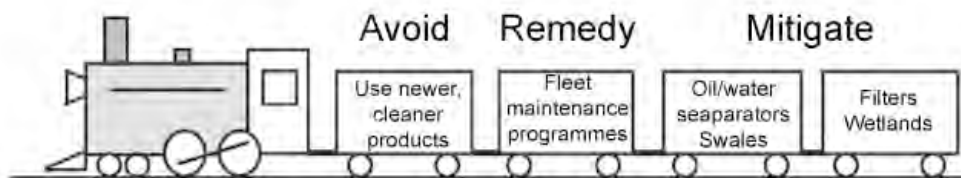

Once source control has been implemented to the degree that it can, contaminant removal and peak flow control would then be pursued. A word of caution should be mentioned though with respect to using practices that complement each other and don't serve the same function. A basic question has to also be asked, “Is the incremental improvement of using two or more practices worth the additional expenditure of funds. It may be that two practices do overlap in function but the first practice is easier and less expensive to maintain than the second one and the cost savings would offset the additional construction cost.

Minton (2006) provides a number of recommendations for a treatment train approach that have been adapted in the following Table 6.8 to discuss how various practices may work in conjunction with one another.

Table 6.8 Various desired functions with examples of various stormwater management practices.

Function	Examples
Removal of coarse solids to reduce maintenance costs	Forebay in a wet pond or extended detention dry pond followed by a sand filter
Removal of fine sediments to meet a treatment performance goal	Sand filter followed by a wet pond or wetland
Removal of dissolved contaminants	Sorptive media filter followed by wet pond, wetland or rain garden

Function	Examples
Reduction of petroleum hydrocarbons to prevent clogging of a second treatment practice	API unit followed by a sand filter or rain garden
Removal of litter to prevent clogging or fouling a second treatment practice	Continuous deflection separation followed by a wetland
Infiltration	Swale followed by an Infiltration practice
Aesthetics	Rain garden followed by a wetland
Wildlife habitat	Rain gardens followed by a wetland
Reliability of long-term performance	Wet pond followed by a wetland

Recommendations also adapted from his overall list include the following:

- Follow the golden rule: Don't place in a treatment train two practices that have the same function.
- Conversely, follow the second golden rule, which is to have a different function for each element of the treatment train.
- When considering a specific system component, the specific contaminant to be removed should be identified, rather than thinking in terms of a general removal of multiple contaminants.
- Any two elements of the system should be considered separately.
- Recognise that including a second element may provide minor benefit.
- The additional expected benefit of an additional element should be compared to the incremental cost of the added element operation.
- Care should be taken when calculating efficiency of the overall treatment train.

An example of a treatment train approach could be the use of swales adjacent to a roadway. The swales would then discharge into a wet pond or a wetland. The combination of practices would provide water quantity control and water quality control for sediments and dissolved metals. Depending on the outlet design of the wetland, hydrocarbons would be volatilised and evaporate. The combination of practices would provide excellent water quality control.

6.9 Bibliography

Auckland Regional Council, Stormwater Management Devices: Design Guidelines Manual, Second Edition, May 2003.

Department of Natural Resources, Standards and Specifications for Infiltration Practices, Water Resources Administration, February 1984.

Greater Wellington Regional Council, Landslide Hazard, Emergency Management.

Rowe, D., Quinn, J., Parkyn, S., Collier, K., Hatton, C., Joy, M., Maxted, J., Moore, S., Stream Ecological Valuation (SEV): A Method for Scoring the Ecological Performance of Auckland Streams and for Quantifying Mitigation, Auckland Regional Council, Technical Publication No 302, 2006.

Black, P., Water Quality Patterns During a Storm on a Mall Parking lot, Water Resources Bulletin, 16, 4, 615, 1980.

Richardson, J., Boubée J.A.T., West D.W., Thermal Tolerance and Preference of Some Native New Zealand Freshwater Fish, New Zealand Journal of Marine and Freshwater Research 28: 399-407, 1994.

- Quinn, J., M., Steele, G., L., Hickey, C., W., Vickers, M.L., Upper Thermal Tolerances of Twelve New Zealand Stream Invertebrate Species, *New Zealand Journal of Marine and Freshwater Research* 28: 391-397, 1994.
- Hoey, J., Girts, M., Technical Memorandum: Stormwater Management Cost Information, prepared for Washington Stormwater Policy Advisory Committee, December, 2000.
- Simons, M., J., Effects of Elevated Temperature on Three Migratory Fish from the Waikato River, Technical Publication 40, Hamilton, New Zealand, Waikato Valley Authority, 1986.
- Kennedy, Paul, The Effects of Road Transport on Freshwater and Marine Ecosystems, Ministry of Transport, June 1999 and updated October 2003.
- Maxted, J., R., McCready, C., H., Scarsbrook, M., R., Effects of Small Ponds on Stream Water Quality and Macroinvertebrate Communities, *New Zealand Journal of Marine and Freshwater Research*, Vol. 39: 1069-1084, 2005.
- Ward, J., Scrimgeour, F., Auckland Regional Stormwater Project: An Economic View, June 1991.
- Horner, R., Skupien, J., Livingston, E., Shaver, E., Fundamentals of Urban Run-off Management: Technical and Institutional Issues, Terrene Institute in cooperation with the U.S. Environmental Protection Agency, August 1994.
- Minton, G., R., Treatment Trains, Don't Get Run Over, *Stormwater Journal for Surface Water Quality Professionals*, July/August Issue, 2006.

Part 7: Hydrology and water quality

When considering hydrologic design criteria recommendations, the recommendations have to be considered in light of the issues discussed in Section 3 regarding receiving systems. These issues include:

- Water quantity design criteria;
- Stream channel erosion mitigation criteria; and
- Water quality design criteria.

The following sections discuss the three issues.

It should be noted that there is some variation between BOPRC hydrological and Hydraulics Guidelines and this guideline. The hydrologic design method here is for design of stormwater management practices where the design approach for the Hydrological and Hydraulics Guidelines is primarily focused on catchment-wide approaches in rural and river situations. The appropriate method should be used for specific situations.

7.1 Water quantity design

There are two purposes for implementation of water quantity control:

- Preventing existing flooding problems from getting worse; and
- Controlling intermediate storms to minimise potential increases in out-of-bank flows downstream.

Both of these situations may be encountered on a specific project on a case-by-case basis. It is important to define the source of flooding problems and situations where flooding issues need to be considered.

The situation considered in this guideline is flooding in the context of being caused or exacerbated by impervious surfaces. These surfaces increase stormwater run-off from a pre-development condition that may have been pasture or bush. It is not the intent of this guideline to consider flooding from a tidal surge context. Thus, flooding issues are considered on streams or reticulation systems located within catchments that drain rainfall-generated run-off and are not tidally induced flooding.

7.1.1 Preventing existing flooding problems from getting worse

It is imperative that projects not increase the risk of downstream flooding where there is flooding potential for existing structures. Structures, in this context could be habitable buildings or highways.

Where there are downstream flooding problems, peak discharges for the post-development 100-year (1% AEP) storm may need to be managed to ensure that downstream flood levels are not increased. Depending on the catchment, the number of tributaries and the location of the project in a catchment, timing of stormwater discharges may be an issue.

Two bodies of work have been done related to preventing increases in downstream flood potential when hydrologic analyses have not been done on a catchment-wide basis. In a study on the Flat Bush catchment in Manukau City (MCC, 2004) MCC limits post-development peak flow at 80% of the pre-development flow rate. The 80% flow rate was based on a catchment hydrological model. This is to compensate for the increased volume of run-off as a result of development in the catchment. Normal attenuation of this run-off in ponds considerably extends the duration of sub-catchment peak flows, resulting in a greater coincidence of peaks and therefore a greater combined downstream discharge than occurs in the pre-development situation. The indicative target of 80% is necessary to avoid any cumulative hydrological effects that could increase the peak flow downstream.

In another study, catchment studies in New Jersey, U.S. (Shaver *et. al*, 2007) the following Figure 7.1 details identical criteria to the Manukau City 80% figure for catchments there. Figure 7.1 shows locations throughout the catchment with location 1 being the site. The vertical axis shows the ratio of post-development peak discharge and pre-developed peak discharge where the value of 1 is where the two discharges are the same. Using the 80% criteria shows that the ratio is always less than 1 as you travel through the catchment.

Figure 7.1 - Comparison of pre and post 100-year peak rates for Middle Brook Catchment (red line is existing, black line is modelled with detention)

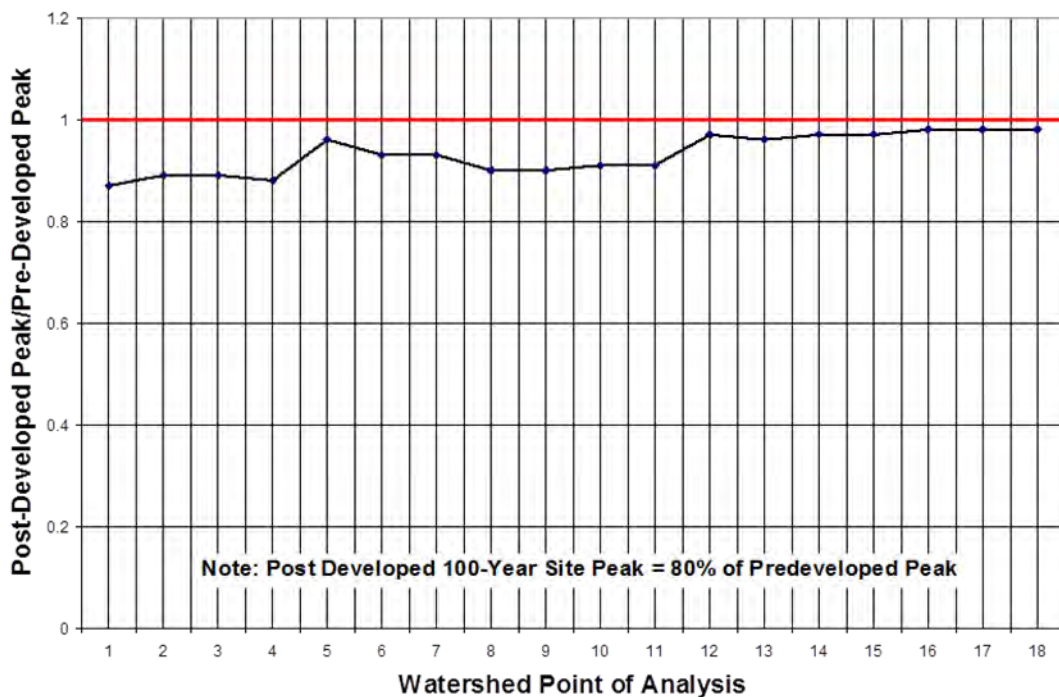

An examination of this comparison shows that, under this level of peak rate control, post-developed run-off rates are less than pre-developed for the entire storm. This increased time period offers greater opportunity for this and other post-developed site hydrographs with similar levels of control to combine downstream in such a way as to produce a total downstream peak that is no greater than the pre-developed peak at that location.

BOPRC would prefer, in situations where there are existing downstream flooding problems (to habitable structures or roads), that a catchment-wide analysis be done to determine potential adverse effects of upstream development. This would allow specific design requirements to be implemented.

In the absence of a catchment study that evaluates a potential project in a given location, it is important to err on the side of caution, especially where human safety or structure damage is concerned. As such, in catchments where flooding problems do exist, it is recommended that the post-development peak discharge for the 100-year storm for a new development be limited to 80% of the pre-development peak discharge.

7.1.2 Controlling intermediate storms

The intent of peak discharge control of storms is to limit downstream increases in larger storm frequencies from the two-year storm and larger. The issue of which storms to control has been considered (Department of Natural Resources, 1982) through an analysis of a number of different policies for peak flow control. By considering a wide range of policies in conjunction with their peak flows, volumes and timing the effects of the various policies can be visually represented through flow duration curves and hydrographs. Figure 7.2 shows a comparison of flood frequency curves for various stormwater management policies.

Figure 7.2 - Comparison of flood frequency curves for various stormwater policies

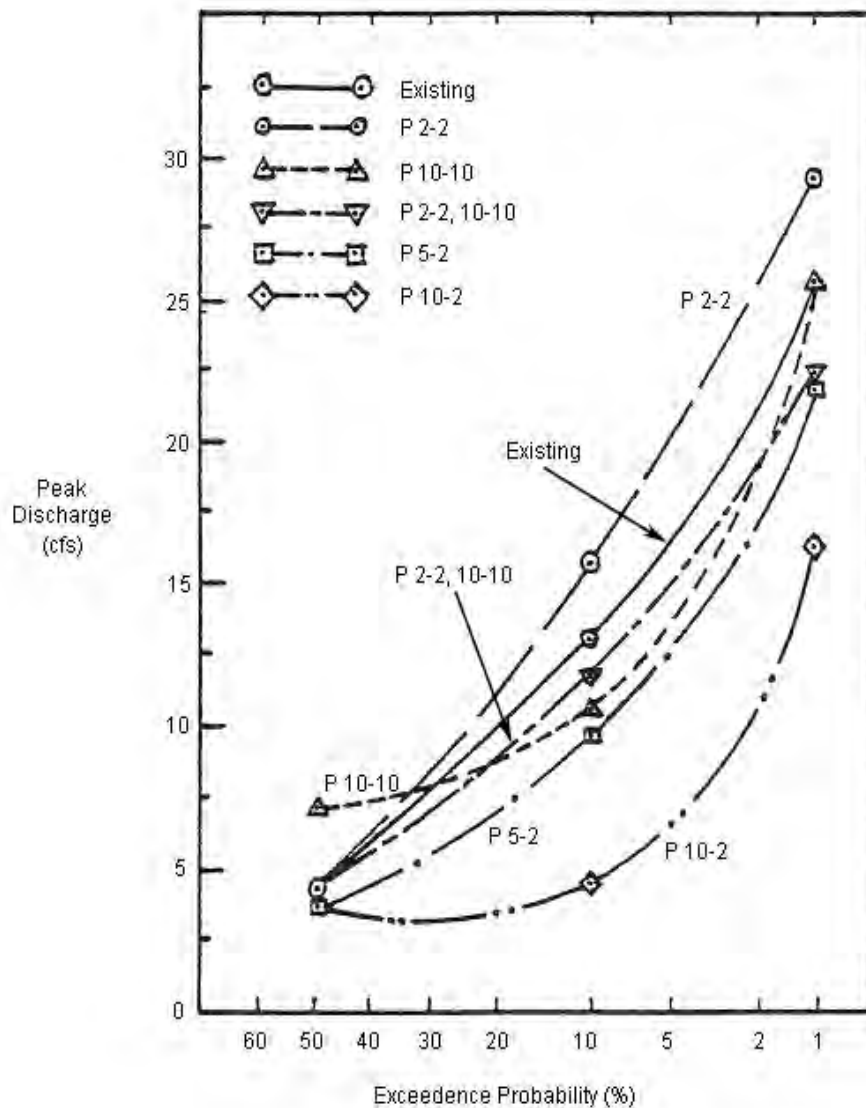

To explain what the numbers mean, P stands for policy while the first number after the P stands for the post-development storm frequency and the second number stands for the pre-development storm frequency. A P 2-2 reflects a policy where the post-development peak discharge for the two-year storm cannot exceed the pre-development peak discharge for the two-year storm. A P 5-2 policy means that the post-development five-year peak discharges cannot exceed the two-year pre-development peak discharge.

What can be seen from the figure is that the 2-2, 10-10 (post-development two-year storm cannot exceed the pre-development two-year storm and the ten-year post-development storm cannot exceed the pre-development ten-year storm) comes closest to matching the existing frequency curve. By providing multiple storm controls the post-development frequency curve comes closest to the pre-development frequency curve. Matching the two and ten-year post-development storms to their pre-development level is a common way of minimising downstream intermediate storm peak discharge increases.

7.1.3 Catchment location

A major consideration regarding imposition for peak discharge control is catchment location. As a general rule stormwater detention for peak flow control should only be done in the top half of a catchment where the potential for coincidence of peaks cannot occur. Figure 7.3 shows an orange line in the approximate mid-point location on the Rangitāiki River where detention below this location could increase the downstream risk of flooding. There can be some confusion regarding timing issues around the catchment mid-points and BOPRC should be consulted regarding those areas.

The same concern does not apply to erosion control criteria, where imposition of volume or extended detention control are required throughout the catchment.

7.1.4 Design rainfall calculations

BOPRC accepts design rainfalls using NIWA's High Intensity Rainfall Design System (HIRDS), version 3 (2010). For projects in the City of Tauranga, designers should be aware that TCC uses local rainfall data (OPUS, 2005) and that rainfall data should be used for projects in the city.

Another point is that climate change should be accounted for in the post-development calculations to determine storage requirements for stormwater management practices.

Figure 7.3 - Example of catchment location determining peak control requirements



7.1.5 Hydrologic design method

The hydrologic analysis approach for this guideline is the Rational Formula. The Rational Method was developed approximately 150 years ago and is still widely used internationally. There are some limitations to use of the method but it does provide reasonable peak discharge results on small catchments with relatively uniform land use. There is a good discussion on the use of the Rational Method in Appendix C of the NZWERF Guideline (2004). In addition to that the City of Christchurch has a detailed discussion of the Rational Method in their Waterways, Wetlands and Drainage Guide (2003).

It is only suitable for small catchments as the method does not account for catchment storage during flood events, but it is appropriate for small sites (that is it fits within limitations on the use of the toolbox set out in Part A. NZWWA (2004) recommends that it not be used for catchment areas in excess of 50 ha. For sites or catchment areas greater than 50 ha the intended hydrologic design method shall be submitted to council prior to initiation of modelling to ensure that the design approach is acceptable.

The Rational Formula is the following:

- Q_{wq} = 0.00278 CIA
- Q = Peak discharge
- C = Run-off coefficient
- I = Rainfall intensity (mm/hr)
- A = Catchment area in hectares (ha)

Where the values of 'C' are provided in Table 7.1.

Table 7.1 Rational Formula run-off coefficient values.

Description of surface	C factor
Natural surface types	
Bare impermeable clay with no interception channels or run-off control	0.70
Bare uncultivated soil of medium soakage	0.6
Heavy clay soil types	
Pasture and grass cover	0.40
Bush and scrub cover	0.35
Cultivated	0.30
Medium soakage soil types	
Pasture and grass cover	0.30
Bush and scrub cover	0.25
Cultivated	0.20
High soakage gravel, sandy and volcanic soil types	
Pasture and grass cover	0.20
Bush and scrub cover	0.15
Cultivated	0.10

Parks, playgrounds and reserves	
Mainly grassed	0.30
Predominantly bush	0.25
Gardens, lawns, etc.	0.25
Developed surface types	
Steel and non-absorbent roof surfaces	0.90
Asphalt and concrete paved surfaces	0.85
Near flat and slightly absorbent roof surfaces	0.80
Stone, brick and precast concrete paving panels	
With sealed joints	0.80
With open joints	0.60
Unsealed roads etc.	
Unsealed roads	0.50
Railway and unsealed yards and similar surfaces	0.35
Land use types	
Fully roofed and/or sealed developments	0.90
Industrial, commercial shopping areas and town house developments	0.65
Residential areas in which impervious area exceeds 35% of gross area (this includes most modern subdivisions)	0.45
<i>Source: Table 2, Document E1, NZ Building Code</i>	

The run-off coefficients are to be modified for slope as follows:

- - 0.05 for slope < 5%
- No adjustment for 5<slope<10%
- +0.05 for 10%<slopes<20%
- +0.10 for slopes >20%

7.1.6 Storm duration and time of concentration

In calculating the peak discharge, the storm duration is normally equal to the time of concentration (t_c) of the catchment. For most small catchments the time of concentration may normally be assumed to be ten minutes. For the purposes of this design guideline the storm duration will be one hour for calculating run-off peak discharges and volumes. If a catchment time of concentration must be calculated, the New Zealand Building Code (2003) has a discussion on calculating the catchment time of concentration. For the purposes of this toolbox t_c is calculated as the following:

$$T_c = t_e + t_f$$

Where:

- T_c = Time of concentration (minutes)
- t_e = Time of entry for overland flow (minutes)
- t_f = Time of network flow (minutes)

Unless another duration is indicated by the site analysis, the storm duration to use for peak control purposes is the one-hour storm.

7.1.7 Volume needs for storage

The estimated volume of storage for a two and ten-year storm can be determined by using the following equation.

$$V_{\text{estimated}} = 1.5 (Q_{\text{post}})D$$

Where $V_{\text{estimated}}$ = Required storage volume (m^3)

Q_{post} = Post-development peak discharge rate (m^3/s)

D = Duration of storm (s)

This equation gives the total run-off volume for the storm analyses. For the purposes of this toolbox, the storm duration is one hour (3,600 seconds). The 1.5 constant was used to provide reasonable volume estimates when compared with the volumes predicted doing a number of case studies using the unit hydrograph method provided in the Auckland Region's TP 108. The general equation is based on a trapezoidal hydrograph with storm duration greater than the time of concentration. If the storm duration equalled the time of concentration, a triangular hydrograph would have been used but the volume requirements fit a one-hour storm better than a ten-minute T_c . The approach provided here gives an approximate volume when compared with a more sophisticated approach, is slightly conservative and should be used unless another method is used that is acceptable to council.

The Rational Formula provides a peak rate of run-off and the rainfall intensity (the 'i' factor) is the maximum rate of rainfall over a one-hour period. It does not necessarily represent the entire rainfall but only represents the peak rainfall intensity.

- (i) Checking calculations of the Rational Formula peak discharge versus the peak rate of discharge using a unit hydrograph approach, there was fair agreement, which is logical since the unit hydrograph and rational i factor are based on the peak rainfall that occurs during the storm. The unit hydrograph approach used a Chicago hydrograph with storms clustered so the peak of one method gives a somewhat close approximation to the other method.

There are differences in the total volume of run-off for the two methods. This wasn't surprising as the Rational Method is only based on peak intensity and not total storm volume. The method was developed to size channels and pipes and there wasn't a need to consider total volume as pipe or channel size was only based on peak rates. From a stormwater management perspective the unit hydrograph approach has been used as the total storm volume now becomes important and that calculation of volume has to be based on total storm volume and not only the peak storm intensity.

So, the detention volumes are based on a 24-hour storm, which represents the entire storm volume and not just the one-hour peak intensity. As a result, the total detention volume will exceed the volume that occurs during the peak intensity period. The conversion factor (1.5) is used to convert the peak period of intensity to a total storm volume. The conversion factor does not relate to time of concentration as that would still relate to the peak rate of discharge.

The calculation should be done for two and ten-year storms when peak control is required for those intermediate storms. The pre-development peak discharges shall be based on one-hour rainfall without considering global warming. The volumes of storage shall be based on the peak flows in the post-development land use assuming global warming.

7.1.8 Effects of climate change

The Resources Management Act Amendment Act (March 2004) requires councils to have particular regard to the effects of climate change. Incorporating climate change predictions into stormwater design is important if infrastructure is to maintain the same level of service throughout its lifetime.

In terms of rainfall around the country (Ministry for the Environment, 2010), mean rainfall will vary around the country, and with season. Decreases in annual mean are expected in the Bay of Plenty Region. In terms of extreme rainfall, heavier and/or more frequent extreme rainfalls are expected; especially where mean rainfall increase is predicted. For the Bay of Plenty region the average change in temperature is expected to be approximately 3°C.

The two and ten-year ARI daily storm events are used to confirm a device's ability to convey peak flows under moderately severe conditions. For device components with a design life greater than 25 years the storm event post-development precipitation values (two and ten-year) should be adjusted to account for climate change. The values obtained from HIRDS for the two and ten-year rainfall should be increased by the percentages listed in Table 7.3 unless locally, more detailed data provides more accurate recommendations.

Table 7.3 Factors (percentage adjustments) for use in deriving extreme rainfall information for screening assessments (Table 5.2 from MfE, 2008).

Duration	ARI (Years)						
	2	5	10	20	30	50	100
<10 minutes	8.0	8.0	8.0	8.0	8.0	8.0	8.0
10 minutes	8.0	8.0	8.0	8.0	8.0	8.0	8.0
30 minutes	7.2	7.4	7.6	7.8	8.0	8.0	8.0
1 hour	6.7	7.1	7.4	7.7	8.0	8.0	8.0
2 hours	6.2	6.7	7.2	7.6	8.0	8.0	8.0
3 hours	5.9	6.5	7.0	7.5	8.0	8.0	8.0
6 hours	5.3	6.1	6.8	7.4	8.0	8.0	8.0
12 hours	4.8	5.8	6.3	7.3	8.0	8.0	8.0
24 hours	4.3	5.4	6.3	7.2	8.0	8.0	8.0
48 hours	3.8	5.0	6.1	7.1	7.8	8.0	8.0
72 hours	3.5	4.8	5.9	7.0	7.7	8.0	8.0

Note: This table recommends percentage adjustments to apply to extreme rainfall per 1°C of warming, for a range of average recurrence intervals (ARIs). The percentage changes are mid-range estimates per 1°C and should be used only in a screening assessment. The entries in this table for a duration of 24 hours are based on results from a regional climate model driven for the A2 SRES (Special Report on Emissions Scenarios - see MfE, 2008 Appendix 1) emissions scenario.

The entries for ten-minute duration are based on the theoretical increase in the amount of water held in the atmosphere for a 1°C increase in temperature (8%). Entries for other durations are based on logarithmic (in time) interpolation between the ten-minute and 24-hour rates.

In the BOPRC region the increase in annual mean temperature up to the year 2090 is expected to be 2.1°C (middle of the road scenario). While the annual average rainfall is expected to decrease slightly the intensity of storms is expected to increase. The values in Table 6.4 should be multiplied by 2.1 to provide an expectation of rainfall for a given storm.

7.1.9 Recommendation for storm peak discharge control

There are three recommendations related to peak discharge control:

- Where there are existing flooding problems downstream and in the absence of a catchment study that evaluates a potential project in a given location and depending on the location of a project within a catchment (per Section 6.1.3), it is recommended that the post-development peak discharge for the 100-year storm for a new project be limited to 80% of the pre-development peak discharge.
- In terms of intermediate storm control, it is recommended that the two and ten-year post-development peak discharges not exceed the two and ten-year pre-development peak discharges.
- In addition, the rainfall data for the two and ten-year storms should be increased for the post-development condition by the percentages shown in Table 8.4.
- These recommendations only apply to projects located in the top half of catchments so as to avoid concerns over coincidence of peaks aggravating downstream flooding concerns.

7.2 Stream channel erosion

Urban development has the effect of increasing the frequency and magnitude of stormwater flows, particularly during frequent, small storm events. As a consequence, streams suffer stability problems.

The composition of the stream banks and bed are the key factors in stream erodibility. Erosion occurs when the shear stress (the “force” of water flowing along the bed and banks) exceeds the ability of the banks or bed to withstand it. Stream erosion is sensitive to changes in the magnitude of flood flows (Beca, 2001).

Scientists engaged in the study of stream erosion for the most part agree on the primary cause of stream erosion. One study out of the U.S. (Julian and Torres, 2005) concludes that hydraulic bank erosion is dictated by flow peak intensities. A more accurate approach to stream erosion is based on shear stress. In principle, the total shear stress on the bed of a stream is the average stress over the bed of a stream (τ - N/m²) that resists the gravitational forces on the water under uniform conditions (Jowett, Elliott, 2006). In practice, shear stress is difficult to calculate because the water surface slope or energy slope varies across and along the reach of a river.

That being the case permissible velocities can be established to control stream erosion. Table 7.4 provides information on permissible velocities that limit stream channel erosion concerns.

Table 7.4 Maximum permissible velocities (Fortier and Scobey 1926).

Material	Velocity (m/s)
Fine sand (colloidal)	0.46
Sandy loam (non-colloidal)	0.53
Silt loam (non-colloidal)	0.61
Alluvial silt (non-colloidal)	0.61
Ordinary firm loam	0.76
Volcanic ash	0.76
Fine gravel	0.76
Stiff clay	1.14
Graded loam to cobbles (non-colloidal)	1.14
Alluvial silt (colloidal)	1.14
Graded silt to cobbles (colloidal)	1.22
Coarse gravel (non-colloidal)	1.22
Cobbles and shingles	1.52
Shales and hard pans	1.83

A compounding factor relating to stream erosion depends on whether the stream has a floodplain or is an incised gully with channel flow whose depth depends on the amount of water being transported. In situations where there is a floodplain, the erosion potential does not increase significantly once the flow spreads out over the floodplain. As flows increase, the flow spreads out on the floodplain and the depth of flow and velocity do not significantly increase. On the other hand, flow in incised channels progressively increases in velocity and depth as flow increases and leads to further increases in erosion potential.

When addressing stream erosion concerns, there are two methods for meeting erosion control objectives:

- Run-off volume control.
- Detention time control.

The approach to addressing stormwater criteria for each of these situations is considered individually.

7.2.1 Run-off volume control

The volume of run-off can be used as a criterion for developing an erosion control recommendation. It is necessary to specify both the volume (or depth) of run-off to be stored and the duration over which this volume may generally be infiltrated into the ground. A given volume of run-off might be specified for retention and that run-off must pass through the retention system and infiltrate in a given period of time, which would depend on the inter-event time period during that time of year when the average inter-event dry period is least. An example of this is that storms in Auckland during winter months occur approximately every two days. In that scenario, the retained volume must be drained within 48 hours to ensure that the storage volume is available for the next storm.

Lacking any more specific rainfall data for the Bay of Plenty region, it is assumed that the two-day inter-event dry period during the winter months is a reasonable figure.

It is also important to consider LID as a design element to reduce increases in stormwater run-off volume. Reduction in site disturbance, soil compaction, and impervious surfaces all translates into a reduction in increases in stormwater run-off volume and peak rates of discharge.

LID should be incorporated into all site development plans to reduce potential impacts on receiving systems.

7.2.2 Detention time control

An alternative to run-off volume control is to establish an extended detention time, which is the time interval between the times of the inflow and outflow hydrographs when a defined percent of the volume has been discharged. In this situation duration of flow is recommended that effectively separate the detained flow from the storm hydrograph. A general recommendation of 24 hours is recommended to achieve this separation.

7.2.3 General Discussion

The intent of volume control or extended detention is to prevent initiation or aggravation of stream channel erosion. By reducing the total volume of water running off the land or extending the time that flows take to travel through the catchment, channel erosion potential is reduced. Figure 7.4 (McCuen, 1987) provides a visual representation of that intent.

In general, the figure relates flow discharge with flow duration. As discussed prior in Section 7.2, peak rates of flow and higher velocities potentially cause channel erosion. Figure 7.4 shows three lines and those lines represent: pre-development flows without extended detention, post-development flows without extended detention, and the post-development condition with extended detention. If channel erosion were at a given flow rate (say 3 m³/s) the red line would indicate where the flow becomes erosive. Both pre and post-development conditions cause stream erosion while the extended detention discharge is below the erosion threshold.

Figure 7.4 - Discharge versus flow duration for pre, post and extended detention

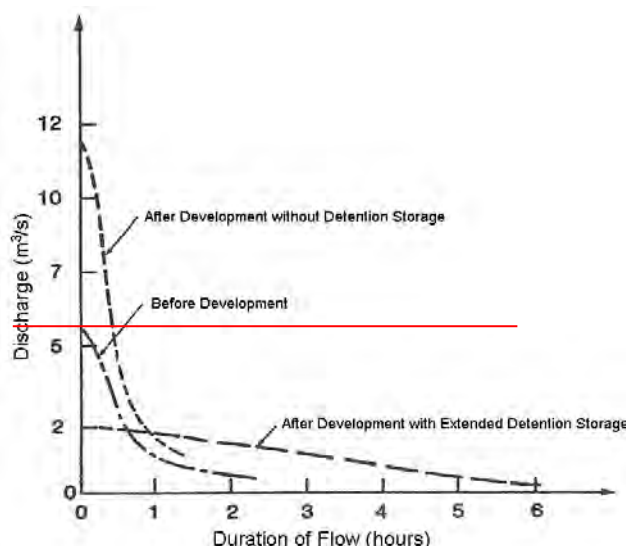

While it is recognised that erosion is a natural process, the intent of volume control or an extended detention criteria is to prevent accelerated level of erosion as a result of increased catchment imperviousness.

There are two questions that need to be addressed:

- What criteria should be established; and
- Where should the criteria be applied?

7.2.4 **What criteria should be established?**

An overseas study (McCuen, 1987) for the case of non-cohesive sediments suggested that the run-off discharged from a detention basin for the post-development conditions and a two-year, 24-hour rainfall should not exceed 25 mm over the 24-hour duration of the design storm. The discharge approximates that of a water quality storm. Work done by Beca, (2001) indicated that for cohesive soils the discharge from a detention basin should not exceed 30 mm over the 24-hour duration storm or within a maximum peak outflow of 7.5 L/s/ha. Beca also recommended having an active storage requirement of up to 130% of the water quality volume as being required to achieve erosion control in cohesive soils.

Another option to specific criteria would be for the project designer to calculate the receiving stream shear stress in the pre and post-construction condition. If the stream is stable then maintain the pre-development peak flow rate and shear stress. If this analysis becomes too complicated then a generalised level of control is recommended.

For the purposes of this guideline, erosion control criteria is regarded as either 1 or 1.2 times the water quality volume, depending on evidence of existing stream erosion, that should be live storage provided within the stormwater management practice to be infiltrated or released over a 24-hour period.

7.2.5 **Where the criteria should be applied?**

The criterion applies to natural (earthen) streams only. It does not have the same limitations or restrictions as peak flow control (top half of catchment), so will be generally recommended throughout a catchment. At the very bottom end of a catchment it is recommended that shear stress analyses be done to determine whether volume control or extended detention is required.

Once tidal limits are reached, there is no need to consider extended detention.

Another situation is where catchment slopes are very slight and velocities of flow are under those provided in Table 6.5. An example of this situation is around Papamoa. In this area, getting the water off the land is the problem and stream velocities for the two-year storm may be below the permissible velocities.

7.2.6 **Water quality credit for extended detention**

One benefit of providing extended detention for stream channel erosion control is that storing and releasing of stormwater over a 24-hour period will provide improved sedimentation due to gravitational sedimentation over that time period. As a result, when used in conjunction with a wet pond or wetland the permanently stored volume calculated for water quality control can be reduced by 50% due to a water quality credit provided by the extended detention. This credit is provided if the criteria provided in Section 6.2.4 are followed.

7.2.7 Recommendations for stream erosion control

The following recommendations are made to address stream channel erosion:

(a) Erosion control criteria

There are three different approaches that can be taken to address stream channel erosion:

- Check the two-year stream velocities against Table 7.4 to ensure that velocities are non-erosive. If they are non-erosive in the post-development condition assuming ultimate development of the catchment under the appropriate district plan land use, then no extended detention is required.
- Implement extended detention or volume control according to the following:
 - If the stream is stable under the existing development condition, design detention or retention storage for a 24-hour release of an equivalent volume to the water quality storm.
 - If the stream is not stable, multiply the water quality volume by 1.2 to determine the extended detention volume. That volume is then stored and released over a 24-hour period.
- Conduct a shear stress analysis for a specific site doing the following:
 - Conduct catchment modelling, i.e. continuous simulation, using land use, initial losses and time of concentration for the catchment in the pre-development condition without the proposed project. Another simulation will then have to be done for the catchment with the development in place.
 - Input climate information including evaporation data and long-term rainfall.
 - Identify a typical downstream cross-section, slope bed material and channel roughness.
 - Apply standard channel hydraulics to the cross-section to get a relationship between the discharge and shear stress.
 - Develop the relationship between shear stress and erosion rate.
 - Combine this with the discharge/shear stress relationship to get a discharge/erosion relationship.
 - Apply the output hydrographs from the hydrological simulations to get the discharge/erosion curve to get the long-term time series of erosion rate.
 - Calculate the long-term erosion with and without the new development to determine whether the project will make erosion worse.

Volume control uses the same volumes as recommended for detention but then infiltrates or otherwise uses (water tanks, designed evapotranspiration) the run-off.

(b) Where applicable

Stream erosion issues are applicable where:

- There is a new project; and
- There is a natural stream; and
- Catchment imperviousness exceeds 3%; and
- There is potential for future development to increase stream channel instability; and
- There is no tidal influence to the stream where the new development discharges to it.

7.3 Water quality design

There are several items that need to be considered when discussing stormwater quality design. These items include:

- General sizing requirements; and
- Effluent limits versus best practicable option (BPO).

7.3.1 General sizing requirements

The size of stormwater run-off event to be captured and treated is a critical factor in the design of stormwater quality treatment practices. If the design run-off event is too small, the effectiveness of the practice will be reduced because too many storms will exceed the capacity of the practice. If the design event is too large, the smaller run-off events will tend to empty faster than desired or the cost of the practice will be greater than the benefit that it provides.

Analytical work to determine optimal policies for rainfall capture (Clar and Barfield, 2004) has indicated that there is a maximised point of run-off volume capture at approximately the 90-percentile storm. The 90-percentile storm is that storm where 90% of all storms on an annual basis are less than. The use of the 90% storm has become widespread throughout the U.S.

In the Auckland region, similar work was done based on rainfall information taken from the Botanic Gardens at Manurewa (1983-1990) (ARC, 1992). The frequency distribution of rainfall for events greater than 2 mm is shown in Figure 7.5. As an example of the information gained by the use of the figure, the distribution indicates that for a storm depth of 25 mm:

- 95% of events would have a lesser depth;
- 80% of the storm volume would be captured if a device could capture up to 25 mm of rainfall;
- Events with a total rainfall depth less than 25 mm have a cumulative rainfall depth of 60% of total rainfall.

Figure 7.5 – Frequency distribution of run-off events

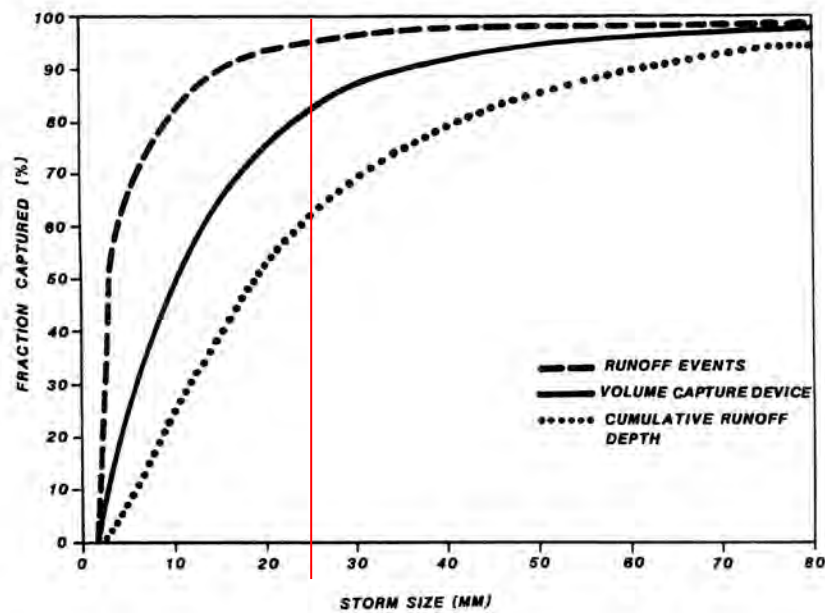

Rainfall in the region is highly variable and the 90% storm shown in Figure 7.6 based on work done by NIWA for New Zealand Transport Agency (2008). A good representation of the 90% storm in a specific location can be found by using NIWA's High Intensity Rainfall Design System (HIRDS), version 3 (2010) where the two-year one-hour rainfall for a given latitude/longitude approximates the 90% water quality rainfall. So, for the Bay of Plenty region the water quality rainfall is provided by using the two-year, one-hour storm as determined by HIRDS version 3.

Figure 7.6 - 90% rainfall for Eastern Bay of Plenty region

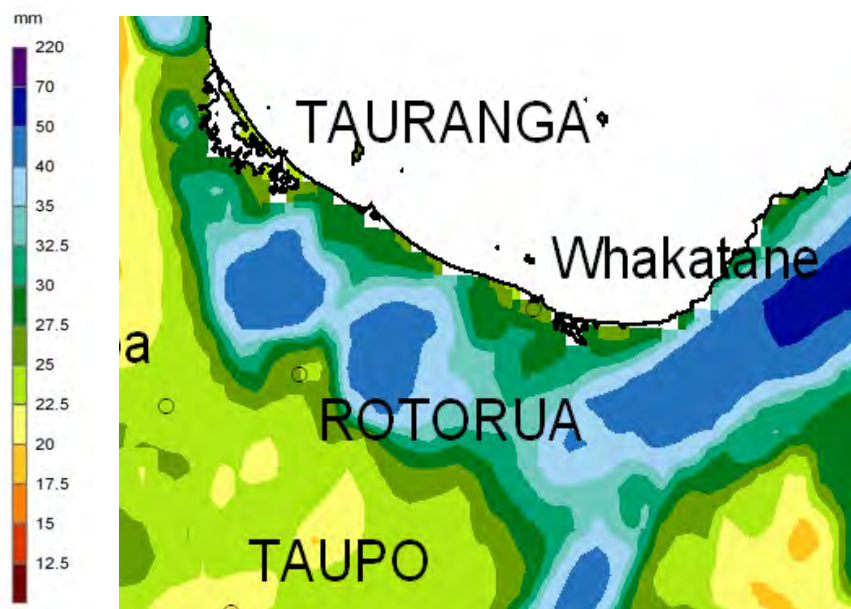

7.3.2 Effluent limits

Bay of Plenty Regional Council uses a Suspended Sediment Concentration (SSE) water quality effluent of not being greater than 150 g/m^3 , except where a ten-minute duration 10% AEP storm event is exceeded. As an example, the ten-year, ten-minute storm for Tauranga is 19 mm of rainfall so storms beyond that intensity can exceed the 150 g/m^3 limit. There are a number of other conditions related to water quality in the regional plan but the only effluent limit is the suspended solids one. Implementation of stormwater management according to these guidelines will normally meet the effluent limit unless a given site has an exceptional sediment load that may overwhelm a given practice. Those situations will have to be considered individually for appropriate design requirements.

7.3.3 Recommendations for water quality control

The following recommendations are made:

- (a) Where sediment is the contaminant of concern
 - The 90% storm should be used for determining water quality treatment volumes and flow rates in sizing stormwater management practices.
 - In areas where the 90% storm is greater than 30 mm, water quality treatment will use 30 mm of rainfall for design purposes.
 - Implementation according to this guideline will normally meet BOPRC effluent limit guidelines.
- (b) Where nutrients are the contaminants of concern
 - The 90% storm should be used for determining water quality treatment volumes and flow rates in sizing stormwater management practices.
 - In areas where the 90% storm is greater than 30 mm, water quality treatment will use 30 mm of rainfall for design purposes.
 - Due to the limited ability of individual stormwater management practices to achieve significant removal of nitrogen, a treatment train approach must be used to improve efficiency. This will necessitate at least two practices used in conjunction with one another to improve nitrogen capture. See Section 7.4 for more detail on this issue.

7.3.4 Calculating water quality volumes

The Rational Formula does not calculate volumes of run-off but rather calculates peak discharges for various storm intensities. Calculate the water quality volume to be treated by using the 90% storm. The City of Christchurch has a simple method of determining the first flush volume in their Waterways, Wetlands and Drainage Guide (2003) where the water quality volume (their first flush volume) and the following approach is based on that method but also accounts for pervious flow contribution.

Calculating the water quality volume is done by the following two calculations.

$$A_{wq} = 0.9 (\text{imp. \%}/100) \times \text{total site area} + 0.15 (\text{pervious \%}/100) \times \text{total site area}$$

Where total site area = m^2

$$\text{The water quality volume } V_{wq} = (90\% \text{ storm}) A_{wq}$$

Where 90% storm depth is in metres (m)

Use this method to calculate the water quality volume storage.

7.4 Summation of recommendations

7.4.1 Peak flow control

There are three recommendations related to peak discharge control:

- Where there are existing flooding problems downstream and in the absence of a catchment study that evaluates a potential development in a given location and depending on the location of a project within a catchment, it is recommended that the post-development peak discharge for the 100-year storm for a new development be limited to 80% of the pre-development peak discharge.
- In terms of intermediate storm control, it is recommended that the two and ten-year post-development peak discharges not exceed the two and ten-year pre-development peak discharges.
- In addition, the rainfall data for the post-development two and ten-year storms should be increased by the percentages shown in Table 6.4.
- These recommendations only apply to projects located in the top half of catchments so as to avoid concerns over coincidence of peaks aggravating downstream flooding concerns.

7.4.2 Stream erosion control

The following recommendations are made to address stream channel erosion.

(a) Erosion control criteria

There are three different approaches that can be taken to address stream channel erosion:

- Check the two year stream velocities against Table 7.4 to ensure that velocities are non-erosive. If they are non-erosive in the post-development condition assuming ultimate development of the catchment under the appropriate district plan land use, then no extended detention is required.
- Implement extended detention or volume control according to the following:
 - If the stream is stable under the existing development condition, design detention or retention storage for a 24-hour release of an equivalent volume to the water quality storm.
 - If the stream is not stable, multiply the water quality volume by 1.2 to determine the extended detention volume. That volume is then stored and released over a 24-hour period.
- Conduct a shear stress analysis for a specific site doing the following:
 - Conduct catchment modelling, i.e. continuous simulation, using land use, initial losses and time of concentration for the catchment in the pre-development condition without the proposed project. Another simulation will then have to be done for the catchment with the development in place.
 - Input climate information including evaporation data and long-term rainfall.

- Identify a typical downstream cross-section, slope bed material and channel roughness.
- Apply standard channel hydraulics to the cross section to get a relationship between the discharge and shear stress.
- Develop the relationship between shear stress and erosion rate.
- Combine this with the discharge/shear stress relationship to get a discharge/erosion relationship.
- Apply the output hydrographs from the hydrological simulations to get the discharge/erosion curve to get the long-term time series of erosion rate.
- Calculate the long-term erosion with and without the new project to determine whether the highway will make erosion worse.

Volume control uses the same volumes as recommended for detention but then infiltrates or otherwise uses (water tanks, designed evapotranspiration) the run-off.

(b) Where applicable

Stream erosion issues are applicable where:

- There is a new development project; and
- There is a natural stream; and
- Catchment imperviousness exceeds 3%; and
- There is potential for future development to increase stream channel instability; and
- There is no tidal influence to the stream where the new development discharges to it.

7.4.3 Water quality control

The following recommendations are made:

- 1 The 90% storm be used for determining water quality treatment volumes and flow rates in sizing stormwater management treatment practices.
- 2 In regions where the 90% storm is greater than 30 mm, water quality treatment will use 30 mm of rainfall for design purposes.
- 3 Implementation according to this guideline will normally meet BOPRC effluent limit guidelines.
- 4 In the Rotorua Lakes Catchment areas, at least two practices should be used in conjunction with one another to improve removal of nitrogen from the stormwater discharge.

7.5 Bibliography

- Beca Carter Hollings & Ferner Ltd., Flat Bush Catchment Management Implementation Plan, Version A6, prepared for Manukau City, June 2004.
- Shaver, E., Horner, R., Skupien, J., May, C., Fundamentals of Urban Run-off Management: Technical and Institutional Issues, 2nd Edition, North American Lake Management Society, 2007.
- Department of Natural Resources, The Effects of Alternative Stormwater Management Design Policy on Detention Basins, State of Maryland, 1982.
- Opus International Consultants Ltd., Tauranga City High Intensity Rainfall Update October 2005, done for Tauranga City Council, 10 October 2005.
- Department of Building and Housing, Compliance Document for New Zealand Building Code, Clause E1, Surface Water, Reprinted September 2003.
- Beca Carter Hollings & Ferner Ltd., Stream Erosion: A Hydological Basis for Management, prepared for Auckland Regional Council, December 2001.
- Ministry for the Environment, Tools for Estimating the Effects of Climate Change on Flood Flows, A Guidance Manual for Local Government in New Zealand, May 2010.
- Julian, J.P., Torres, R., Hydraulic Erosion of Cohesive Riverbanks, Department of Geological Sciences, University of South Carolina, Geomorphology 76 (2006) 193-206.
- Jowett, I., G., Elliott, A., Cohesive Sediment Design Parameters for Auckland Streams, Prepared for the Auckland Regional Council, NIWA Client Report, July 2006.
- Fortier, Scobey, Maximum Permissible Velocities Recommended and the Corresponding Unit-Tractive Force Values, recommended for use in 1926 by the Special Committee on Irrigation Research of the American Society of Civil Engineers, 1926.
- McCuen, R., H., Moglen, G., E., Kistler, E., W., and Simpson, P., C., Policy Guidelines for Controlling Stream Channel Erosion with Detention Basins, Department of Civil Engineering, University of Maryland, 1987.
- Clar, M., L., Barfield, B., J., Stormwater Best Management Practice Design Guide, Volume 1, General Considerations, EPA-600/R-04/121, September 2004.
- ARC, Stormwater Treatment Devices: Design Guideline Manual, Technical Publication No. 10, October 1992.
- New Zealand Water Environment Research Foundation, On-Site Stormwater Management Guideline, October 2004.
- New Zealand Transport Agency, Stormwater Treatment Standard for State Highway Infrastructure, draft document March 2009.
- ANZECC, National Water Quality Strategy: Australian and New Zealand Guidelines for Fresh and Marine Water Quality, Australian and New Zealand Environment and Conservation Council and Agriculture and Resources Management Council of Australia and New Zealand, Canberra, Australia, 2000.
- Christchurch City Council, Waterways, Wetlands and Drainage Guide, Part B: Design, 2003.

Part 8: Design procedures for incorporation of LID into site design

8.1 Introduction

BOPRC is giving strong preference to supporting the implementation of LID as an evolutionary step in our use of land. As such, all new development activities need to answer a series of questions or checklist items during the site design process. If site designers ask these questions and consider what their responses to those questions are then LID is accomplished. The most important aspect of LID is that it achieves a new way of thinking about site design.

The approach provided here is simplistic and attempts to avoid the temptation to become overly detailed and complicated. There are thousands of variations to LID and no amount of detail will cover every situation.

In terms of approach in this Section, individual components of site design will be provided in a checklist for that component. These individual components are grouped so that an overall checklist for the LID process is followed.

8.2 Design procedure in overview

As design procedures go, LID is simple as shown in Figure 8.1. The procedure is based on using an analysis of existing site conditions as a baseline from which to start from. These existing site conditions provide an inventory of the full range of natural systems - water, soil, geology, vegetation, and habitat - as well as cultural and archaeological factors. These systems range from the very macro in scale for resources of region wide significance, down to micro scale site-specific conditions, such as steep slopes or the presence of first or second order streams. The more this complex system is documented and understood from the start, the better the earthworks and building programme can be fitted on the site with reduced impact. Extra design effort up front will pay important dividends in the long run. LID requires a major departure from the conventional mindset of site disturbance and stormwater disposal, which is a reactive approach with an end of the line process forcibly imposed through a consent requirement. LID is based on understanding natural system opportunities, which enable us to achieve essential stormwater quantity and quality management objectives integrated into the development design from the very beginning.

LID requires that a series of questions be answered which, from an earthworks and stormwater perspective, are preventive in nature. If these questions are addressed, the reduction of stormwater run-off can be maximised. In most situations, sediment control and stormwater mitigation will still be required due to site disturbance and the increased volume and peak rates of run-off. On-site mitigation efforts in stormwater management should attempt to use less impacting forms of management such as incremental stabilisation and vegetated swales or filters where practical, but more structural forms of management such as ponds or wetlands will still possibly be required although their sizes will be reduced from the conventional site development approach.

A relevant analogy to the benefits of LID is the relationship that erosion control has to sediment control. Erosion control during construction is preventive in that it reduces the total amount of sediment generated. Sediment control attempts to reduce downstream delivery of sediment through the use of mitigative practices. LID is similar to erosion control as it is preventive. Conventional stormwater management is like sediment control in that it attempts to reduce adverse impacts rather than preventing them.

The most important aspect shown in Figure 8.1 is the conceptual earthwork and stormwater management plans being done concurrently with the entire site design process. All of the preventive and mitigative steps link into the conceptual process. The building programme, site design including earthworks, and stormwater management concept are integrated and optimised. This integration of erosion and sediment control and stormwater management issues into site design from the start of the design process is essential to LID.

Figure 8.1 – Low-impact design approach

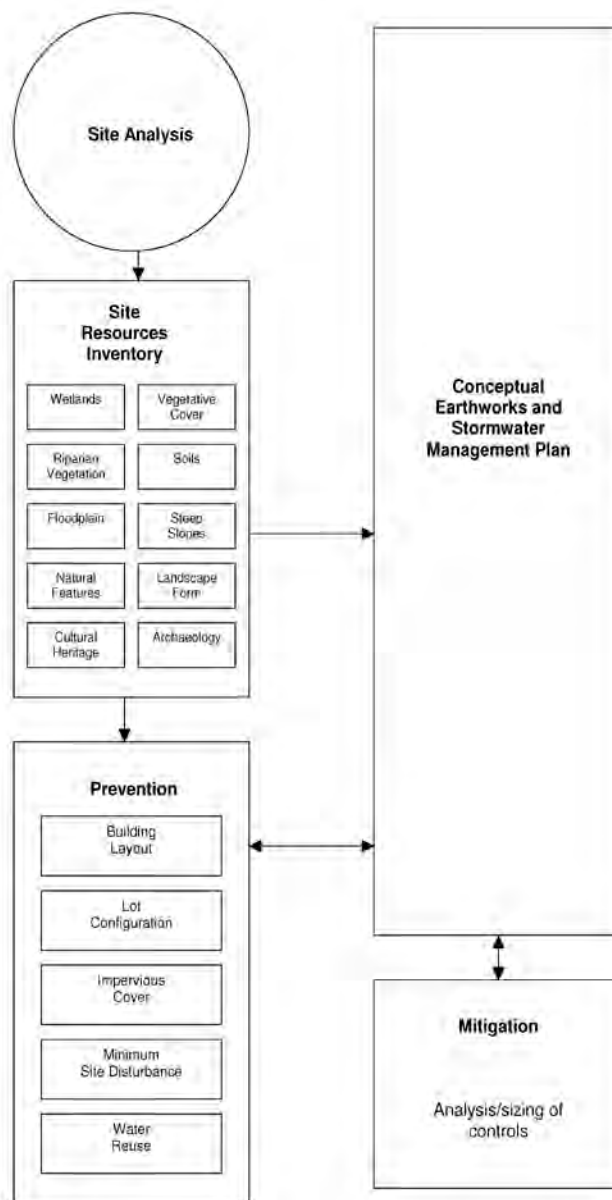

8.3 LID design approach

LID presents a series of questions or checklist items that should be answered as the design process proceeds. If a designer asks these questions and considers their response then LID is accomplished. The most important aspect of LID is that it achieves a new way of thinking about site design.

The process should not become overly complicated as there are thousands of variations and you won't be able to cover every situation.

One key theme that permeates the overall process is to have a minimum earthworks strategy. The less site modification that occurs, the less adverse effects will occur.

There are individual sections to the process depending on the aspect of site design that is being considered. Those processes include the following items:

- General context information;
- LID ancillary benefits;
- Site natural features analysis;
- Hydrologic factors;
- Building considerations;
- Lot configuration;
- Impervious surface reduction;
- Minimisation of site disturbance;
- Calculation considerations; and
- Mitigation considerations.

These considerations are appropriate at a site or subdivision level of development. In addition, catchment development would have a number of similar factors along with some additional ones as detailed in its own checklist that is provided in Section 11. The last checklist listed in Section 9 relates to ancillary benefits that need to be considered during the LID design process.

8.3.1 General context information

General context information considered		
Information	Yes	No
The surrounding land context (rural, urban, vegetation, etc.)		
The site position in a catchment (top, middle, bottom)		
Site size		
Structure plan, district plan, network consent, code of practice indicate ranges of development for this site and adjacent ones		

8.3.2 LID ancillary benefits

Ancillary benefits considered		
Information	Yes	No
Urban design components		
Crime prevention through environmental design		
Energy efficiency		
Ecology		
Landscape amenity		
*Note: for a detailed breakdown please refer to the LID ancillary benefits checklist in Section 8.3.12.		

8.3.3 Site analysis

Site natural features considered		
Feature	Yes	No
Wetlands		
Streams (including intermittent ones)		
Floodplains		
Riparian buffers		
Existing site vegetative cover		
Soils		
Depth to groundwater		
Steep slopes (>33% or 18°)		
Other natural site features		
Cultural or archaeological locations		

8.3.4 Receiving environment

Receiving environment factors considered		
Questions to answer	Yes	No
Does the site drain directly to tidewater or the coast?		
Does the receiving system have sensitivities detailed in the RPS, district plan, Conservation Management Strategy, etc.?		
Are there known downstream flooding problems?		
Does the site contain first or second order streams?		
Are any site streams perennial?		
Does the site stormwater discharge to ground?		

8.3.5 Hydrological factors considered

Hydrological factors considered		
Questions to answer	Yes	No
Have you identified the route taken by stormwater run-off from the source to the receiving environment?		
Is the pathway stable enough for stormwater drainage to enter it without eroding?		
Can the pathway provide for stormwater treatment?		
Can site soils be used for infiltration of run-off?		
Can roof or site run-off be used to reduce overall stormwater run-off volume?		
Can revegetation of native vegetation be used to reduce run-off?		
Do impervious surfaces drain directly to receiving waters?		

Circle the appropriate “receiving system” and “stormwater issue” to determine priorities:

Table 3.1 Receiving environments and stormwater issues.

Receiving system	Flooding issues	Stream erosion issues	Water quality
Streams	May be a priority depending on location within a catchment	High priority if the receiving stream is a natural, earth channel	High priority
Ground	Not an issue depending on overflow	Not an issue	High priority
Estuaries	Not an issue	Not an issue	High priority
Harbours	Not an issue	Not an issue	Moderate priority
Open coast	Not an issue	Not an issue	Lower priority
Lakes	Not an issue	Not an issue	High priority

8.3.6 Building considerations

Building programme considerations		
Consideration	Yes	No
Does the site have public sewer?		
Does the site have public water?		
Can the development reduce the total number of units?		
Can the type of units be modified (single family to apartment)?		
Is there flexibility in lot density?		
Is there flexibility in individual lot requirements?		

8.3.7 Lot configuration

Lot configuration considerations		
Consideration	Yes	No
Have lots been reduced in size as far as practicable?		
Have lots been clustered as far as practicable?		
Have lots been configured to avoid important natural features?		

8.3.8 Impervious surface reduction

Impervious surface reduction considerations		
Consideration	Yes	No
Have road lengths and widths been reduced as far as practicable?		
Have driveway lengths and widths been reduced as far as practicable?		
Has potential for shared driveways or parking spaces been explored?		
Have parking ratios and parking sizes been reduced as far as practicable?		
Have cul-de-sacs/roundabouts been designed to minimise imperviousness?		
Has kerbing been reduced to the extent possible or have kerb cuts been used to reduce flow concentrations?		

8.3.9 Minimisation of site disturbance

Site disturbance minimisation considerations		
Consideration	Yes	No
Has maximum total site area, including both soil and vegetation been protected from clearing or other site disturbance?		
Can disturbance of important natural, cultural or archaeological features be minimised?		
Are areas of open space maximised?		
In terms of individual lots, has maximum lot area, including both soil and vegetation, been protected from clearing or other site disturbance?		
Do structures correspond to site features such as slope, both in terms of type of structure, placement on lot, elevation, etc.?		
Have vegetation opportunities been maximised throughout the site?		
Have revegetation opportunities been maximised in important natural areas?		

8.3.10 Calculation considerations

Design calculation considerations		
Consideration	Yes	No
As a result of a decrease in the total disturbed area, are numbers of sediment ponds minimised as far as practicable, and subsequently their size and areal extent also minimised?		
Total sediment yield from the site during construction has been minimised as far as practicable from the conventional approach.		
Could impervious cover be minimised as far as practicable from conventional development?		
Have 'C' factors been reduced as far as practicable from conventional to LID?		
Have total run-off volumes been affected?		
Has the predevelopment time of concentration for site run-off been maintained as far as possible?		

8.3.11 Mitigation considerations

Mitigation considerations		
Consideration	Yes	No
Has the Stormwater Management Plan been integrated into the overall site design?		
Has prevention been minimised through LID considerations?		
Has mitigation been maximised through vegetative and soil based practices such as swales, rain gardens or infiltration practices?		
Can unpreventable impacts be mitigated through conventional stormwater management controls?		

8.3.12 LID ancillary benefits

Urban design		
Information	Yes	No
Context: Fit within the catchment.		
Character: Create vision and identity.		
Choice: Range of options within the development.		
Connections: Pathways through the development.		
Creativity: Innovation for the future.		
Custodianship: The creation of stewardship.		
Collaboration: Involvement of key catchment stakeholders.		

Crime Prevention Through Environmental Design (CPTED)		
Information	Yes	No
Access: Safe movement and connections.		
Surveillance and sightlines: See and be seen.		
Layout: Clear and logical orientation.		
Activity mix: Eyes on the street.		
Sense of ownership: Showing a space is cared for.		
Quality environments: Well-designed, managed and maintained environments.		
Physical protection: Using active security measures.		

Energy efficiency		
Information	Yes	No
Water use options available (roof, mains, grey water etc.).		
Control over the amount of water use and water use options.		
Buildings are insulated (placed underground, green roofs, high 'r' value insulation materials).		
Site design optimises solar exposure for living environments but allows for shading and cooling in summer months.		

Ecology		
Information	Yes	No
Rehabilitation potential for ecological systems.		
Enhanced/capitalised biodiversity of flora and fauna communities.		
Viability of ecological systems and processes.		
Landscape connectivity.		

Landscape amenities		
Information	Yes	No
Conservation: Protection of significant landscape features.		
View protection: Access to existing views.		
Coherence: Are existing landscape shapes maintained.		
Connectivity: Seamless transitions between development and open spaces.		
Scenic appeal: Enhancement of landscapes.		
Access and safety: Allowance for sightlines and orientation.		

8.4 How to measure success

There are several obvious questions that have to be asked when doing LID.

- 1 What are the goals or expectations?
- 2 How do you know when design efforts are completed?

At this time LID does not have a performance standard associated with it. You will not get a defined answer or a specific target value that you are shooting for. The ultimate goal is to prevent change to predevelopment hydrology when site development occurs, but that mission cannot be achieved in 95% of the sites being developed. Table 8.1 summarises the general effectiveness of each of the site design approaches discussed in this guideline. It indicates that most practices are at least moderately effective at providing two or three environmental benefits. Certain practices, notably natural landscaping and cluster development are at least moderately effective in achieving all four of the desired environmental objectives. However, the table also implies that a site design should incorporate several management practices in an integrated fashion to be highly effective in controlling adverse environmental impacts.

Table 8.1 Effectiveness of LID approaches.

LID practice	Run-off rate reduction	Run-off volume reduction	Run-off contaminant reduction	Habitat Protection
Reduced street widths	Moderately effective	Moderately effective	Moderately effective	Limited effectiveness
Reduced building setback	Moderately effective	Moderately effective	Moderately effective	Limited effectiveness
Natural drainage	Moderately effective	Moderately effective	Moderately effective	Limited effectiveness
Natural detention	Very effective	Limited effectiveness	Very effective	Moderately effective
Natural landscaping	Moderately effective	Very effective	Very effective	Very effective
Cluster development	Moderately effective	Very effective	Very effective	Very effective

The effectiveness of natural landscaping and cluster development will depend on how well these approaches are integrated into the overall Landscape and Drainage Plan.

LID presents a modern approach to site design where many existing site development requirements are questioned. The realistic goal of LID is to reduce impacts to the degree possible so that mitigation is minimised while still creating desirable communities. As such, the design approach is based upon a simple question for each aspect of site development - "Why?". Why do we need footpaths on both sides of a street? Why do we need streets to be as wide as they are? Why do lot sizes have to be a minimum dimension? Why do street locations have to be where they are? These questions go on and on throughout site design and they will probably require iterations and second-guessing to get it right.

When are design efforts completed? When the questions outlined in this part have been gone through and completed, and honestly, the process is completed. If the work has blended site resources into the development approach, reduced stormwater run-off as much as possible, and delivered the best product, then the process is finished.

What are the goals or expectations? We have to change the way we use land if we are going to have a desirable environment in the future. One tool in that effort is to change how we develop land and to bring nature more into the urban environment. As demonstrated in a number of sections, our activities have significant impacts on receiving systems in terms of contaminant entry into water and altered catchment hydrology. Our expectations are modest at this time but will certainly increase in the future with hydrologic change to catchments being minimised. Expectations are related to two areas: hydrologic change from pre-development to post-development reduction from a conventional development approach, and site resources and receiving systems should be protected to the extent possible. Our expectations are to see a reduced downstream impact through LID than would have otherwise occurred in a traditional site design.

8.5 Other types of development

LID is commonly thought of as being applicable for residential development as residential development covers the most land area and is the most common form of site development. But commercial, industrial, and even horticultural (especially protected cropping) activities as shown in Table 8.2 can successfully apply LID to reduce their impact on receiving systems. The approach is identical to residential LID in that existing site resources are delineated, site development is integrated into the site, and LID approaches to stormwater treatment are investigated. Not all LID approaches are suited to all development types. For example, site revegetation is most easily done on larger residential lot development, but is less feasible on small commercial development.

Table 8.2 *Appropriateness of LID for selected development types.*

LID Practice	Low density residential	Medium density residential	Multi-family residential	Commercial industrial
Reduced street widths	Generally appropriate	Generally appropriate	Generally appropriate	Occasionally appropriate
Reduced building setbacks	Generally appropriate	Generally appropriate	Occasionally appropriate	Occasionally appropriate
Natural drainage	Generally appropriate	Occasionally appropriate	Generally appropriate	Occasionally appropriate
Natural landscaping	Generally appropriate	Occasionally appropriate	Generally appropriate	Occasionally appropriate
Cluster development	Generally appropriate	Generally appropriate	Occasionally appropriate	Generally not appropriate

Any site being developed can incorporate LID. The greatest potential use of LID on commercial and industrial sites lies with use of the treatment train approach to stormwater management implementation. That is an element of LID but only one element of a broader context. Figure 8.2 is for a small commercial development and demonstrates several LID design principles. Roof run-off reused on site and parking lot run-off enters swales, which are then directed towards a stormwater detention pond having wetland attributes. The site design promotes water reuse, water quality treatment, plus providing control of water quantity peak discharges for the two and 100-year storm events.

As can be seen, the project does have to provide structural stormwater management control but the work done by the controls is augmented by water tanks and swales in addition to benefits provided by the wetlands vegetation.

The same issues related to residential site development requirements exist for commercial and industrial development in terms of kerbing, parking requirements, level of imperviousness, or revegetation opportunities. Almost every site can have steps taken to reduce downstream impact from conventional development approaches. One key important element is that combinations of approaches should be employed in an integrated fashion to maximise cumulative benefits.

8.6 Case studies

Several examples of LID implementation will be shown in case studies on residential subdivisions whose size and density are typical of Tauranga City. There are any number of examples that could be used but these two were considered as typical.

8.6.1 Case Study 1

Residential subdivision having the following:

- 40 hectare site;
- 2,000 m² lots;
- 142 lots;
- Overall imperviousness 30%;
- Conventional storm drain pipe system; and
- 100% site disturbance.

Figure 8.2 - LID on a commercial site

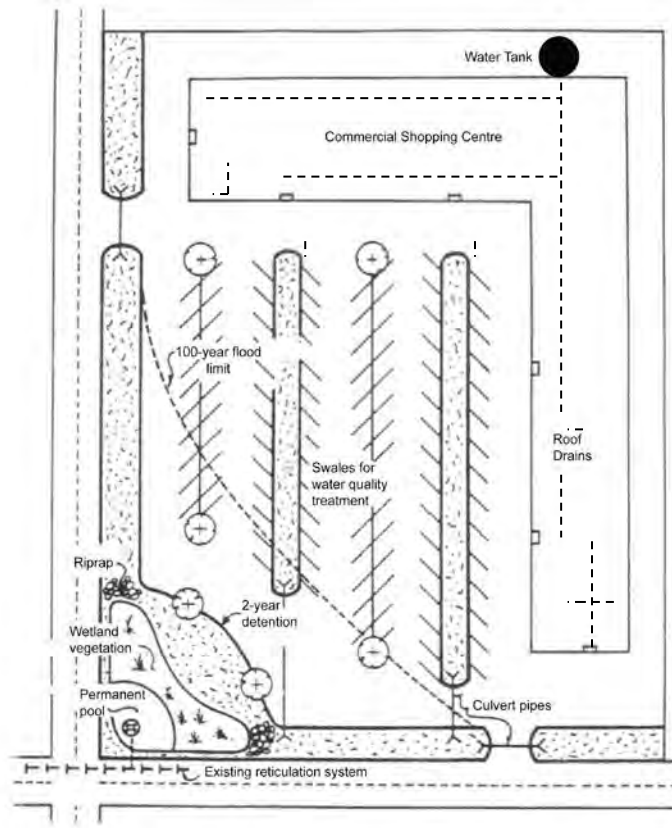

The above approach is a conventional approach that is shown on Figure 8.3.

Figure 8.3 - Typical subdivision development approach showing stormwater management ponds

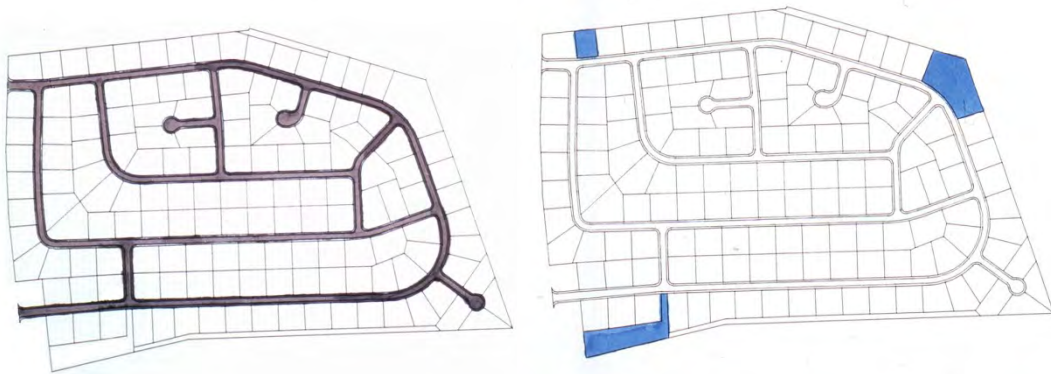

The site was then considered from an LID context to see if benefits could be realised in terms of open space maximisation and reduced hydrological change. The following two approaches were considered in Figure 8.4.

Figure 8.4 - Two different LID approaches to site development

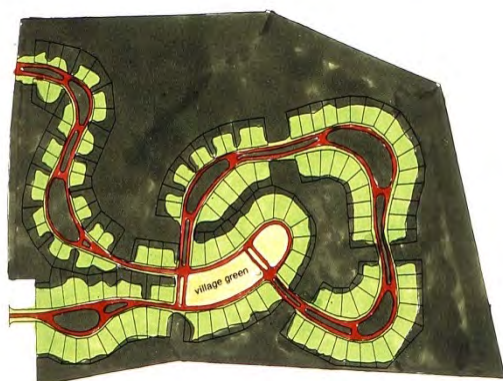

Parkway approach

- 1,000 m² lots
- 50% open space
- 15% imperviousness
- 60% undisturbed



Village Cluster approach

- 500 m² lots
- 72% open space
- 17% imperviousness
- 67% undisturbed

When the water budget for the site is considered for the conventional development, parkway approach and village cluster approach in Table 8.3, the following table is calculated.

Table 8.3 Subdivision annual water budget (m³).

	Pre-development	Conventional development	LID approach (Village)	Even better (Parkway)
Precipitation	432,373	432,373	432,373	432,373
Run-off	18,761	249,515	82,671	67,397
Recharge	154,377	118,552	128,864	134,556
Evapo-transpiration	259,267	194,136	220,611	230,441

As can be seen, the LID approaches provide a substantial reduction in stormwater run-off being discharged on an annual basis with greater levels of groundwater recharge and evapotranspiration from the conventional approach.

These numbers only indicate run-off differences from the modified development approach. They do not consider the benefits of using water tanks for non-potable water use or rain gardens, infiltration practices, swale or filter strips as overall site stormwater management components. Using those practices in conjunction with an LID approach to site land use would result in a similar water budget to the pre-development condition.

8.6.2 Case Study 2

Case Study 2 provides for residential development in a more urban situation. The conventional development approach consists of the following:

- 14.2 ha site;
- 128 lots;
- Average lot size 765 m²;
- Overall imperviousness 69%;
- Reserve 1.09 ha;
- Earthworks area 9.5 ha;
- Earthworks volume 62,000 m³;
- Conventional storm drainage system; and
- 100% site disturbance.

Figure 8.5 shows the predevelopment and conventional site development approach.

Figure 8.5 - Predevelopment site conditions and conventional development approach

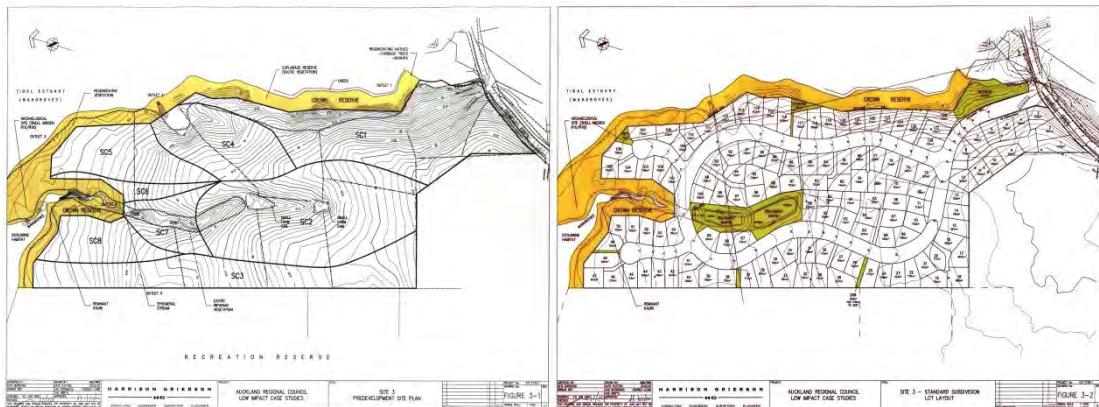

The LID design approach shown in Figure 8.6 provided for the following:

- 138 lots;
- Reserve area of 2.34 ha;
- Average lot size 650 m²;
- Earthworks area 7.6 ha;
- Earthworks volume 53,000 m³;
- Overall imperviousness 51%;
- Conventional storm drainage system; and
- 80% site disturbance.

Figure 8.6 - LID design approach for Case Study 2



In terms of a water budget, the following hydrological information is presented in Table 8.4.

Table 8.4 – Hydrological results.

Storm	Peak flow (m ³ /s)	Run-off (mm)	% increase
Two-year, 24-hour storm			
Pre-development	0.87	34	-
Conventional	1.48	59	74
Low-impact	1.37	52	53
Ten-year, 24-hour storm			
Pre-development	1.89	73	-
Conventional	2.70	106	45
Low-impact	2.59	97	33

Considering the water budget from an increase in total run-off and impacts on stream base flow over a given year, Table 8.5 provides the following information:

Table 8.5 – Changes in annual storm flow and base flow.

Site development status	Rainfall (m ³)	Storm flow (m ³)	Base flow (m ³)
Pre-development	181,638	31,449	39,088
Conventional	181,638	99,160	12,254
Low-impact	181,638	81,945	19,090

As can be seen, there is still a significant increase in site run-off both storm related and annually, but use of an LID approach can reduce site run-off and, in conjunction with stormwater practices, reduce downstream adverse effects.

8.7 Bibliography

Delaware Department of Natural Resources and Environmental Control,
Conservation Design for Stormwater Management, September, 1997.

Northeastern Illinois Planning Commission, Reducing the Impacts of Urban Run-off:
The Advantages of Alternative Site Design Approaches, April 1997.

Ministry for the Environment, New Zealand Urban Design Protocol, March 2005.

Auckland Regional Council, Low Impact Design Manual for the Auckland Region,
Technical Publication #124, April 2000.

Part 9: Detailed stormwater management practice design

9.1 Introduction

The parts up to now have laid the foundation for the need to consider stormwater management, the types of practices that can be used, analytical approaches and recommendations for the form that management should take from a flooding, erosional and water quality perspective. This part is devoted to detailed design approaches for stormwater quantity and quality control.

The part will be broken up to discuss several different areas.

- Source control;
- Design for operation and maintenance; and
- Flow and treatment control.

9.2 Source control

Prior to any consideration of stormwater treatment, consideration should be given to source control and a series of questions answered.

- Have building materials been used that minimise leaching of contaminants?
- Has existing vegetation been preserved to the degree practicable or has vegetation been re-established upon project completion?
- Are flow velocities and volumes increased downstream (energy dissipation)?
- Has slope disturbance been minimised and have disturbed slopes been vegetated and slope lengths minimised through the use of cut-off drains?
- Can concentrated flow areas be minimised?
- Are any cross drains combined and considered for erosion protection?

When these types of questions have been considered and addressed, the stormwater management practice selection process then moves on to flow and treatment control.

9.3 Design for operation and maintenance

As well as water quality and water quantity control, another key element that must be considered during the design phase is operation and maintenance of the practice. There are several key elements that must be considered during the design phase. Asking and answering some questions or giving serious consideration to operation of the stormwater practice and system can answer them.

- Spend a year at the practice;
- Asking maintenance questions such as who, what, when, where and how; and
- Considering the use of uniform materials or components.

9.3.1 Spend a year at the practice

The stormwater designer must imagine conditions at the completed practice throughout an entire year. This should not only include rainy and sunny weather but also consider time of year when evapotranspiration rates are different. Other site conditions may include hot, dry weather or drought when vegetation is stressed or dies. Finally, for safety purposes, the designer should also imagine what the system would be like at night.

As these conditions are visualised, the designer should also imagine how they might affect not only the operation of the practice itself, but also the people that will maintain it or otherwise interact with it. Will the outlet structure trash rack be prone to clogging from vegetation or debris floating in the stormwater run-off? Is there a safety issue related to maintenance for maintenance employees?

This approach is intended to assist the designer to consider and design for possible conditions at the practice, not just for specific storm events.

9.3.2 Asking maintenance questions

Another key element of design should involve asking specific questions that focus on operation and maintenance characteristics or functions of the practice. The questions should include at least:

- (a) Who will perform the maintenance?

Does the design of the practice require operation and maintenance specialists or will someone with general maintenance equipment and training be able to accomplish it?

- (b) What needs to be maintained?

A list of practice components that are part of the design may prompt a revised design with either a shorter list or one that modifies a practice component to facilitate maintenance. An example of this could be a sand filter system that has heavy covers that are not easily removed by hand or require a specialised piece of equipment to lift the covers.

- (c) When will maintenance need to be performed?

Does maintenance have to be done once a day, once a week, monthly or annually? The recurring costs of maintenance can be substantial. In addition, can maintenance only be done during dry weather? If so, what happens during the lengthy time periods of wet, rainy weather? In terms of effort and possible consequences, it is easier for the designer to provide answers to these questions now rather than having the maintenance personnel having to develop an approach later.

- (d) Where will maintenance have to be performed?

Recognising that these practices are being done for new developments within larger development areas, there will always be potential interaction with the public and safety concerns that have to be addressed. Will the maintainer be able to gain easy access to the practice? Once there, will they have a stable, safe place to stand and work? Can the design provide a means for the maintenance contractor to reduce the time on site to conduct maintenance inspections and perform maintenance?

- (e) How will maintenance be performed?

The simple instruction to remove sediment or harvest vegetation can become complicated if there hasn't been any provision made to allow equipment access to the practice or even to the site. Are locks used to limit public access to a practice? If security features are used then there has to be a common key to allow easy access. Stormwater practices cannot become a liability to the local community.

9.3.3 Considering the use of uniform materials or components

Specify materials that will last for as long as the life expectancy of the stormwater management practice might be. If further development is anticipated in 15 years than materials used should last 15 years. Reducing construction costs may have a significant adverse impact on long-term maintenance costs.

It is absolutely essential that the designer consider these issues during the design phase so they can be addressed now rather than being left for later resolution. The design phase may be the shortest amount of time given to a given project when considering construction time and whole-of-life aspects of a development and its stormwater management practices. It is vital that the design attempts to minimise future maintenance obligations and cost while providing for proper protection of downstream areas.

9.4 Consideration of practices in series

While these practices provide individual benefits for removal of contaminants, their use in series can provide greater benefit than those used only individually.

A simplified equation for the total removal of a given contaminant for two or more stormwater management practices in series is the following (State of New Jersey, 2004):

$$R = A + B - [(A \times B)/100]$$

Where:

R = Total removal rate

A = Removal rate of the first or upstream practice

B = Removal rate of the second or downstream practice

The use of this equation is easiest when considering removal percentages rather than using effluent limits as data on performance of practices for effluent limits can be highly variable.

BOPRC has significant interest in sediment and nutrients (in Rotorua Lakes Catchments) as contaminants of greatest concern so practice performance for them is provided in the following Table 9.1. Using the removal rates provided in the table will allow for calculation of overall removal of the contaminant of greatest concern. If metals are a contaminant of concern the Tauranga City Council Stormwater Management Guidelines should be consulted for practice removal rates and calculation of treatment train benefits.

Table 9.1 Removal rates for various stormwater practices for TSS and nutrients.

Practice	Removal rates (%)		
	TSS	Nitrogen	Phosphorus
Swales	70	20	30
Filter strips	80	20	20
Sand filters	80	35	45
Rain gardens (normal)	90	40	60
Rain gardens (w/anaerobic zone)	90	50	80
Infiltration practices	80	30	60
Dry ponds (no extended detention)	40	10	20
Dry ponds (with extended detention)	60	20	30
Wet ponds	75	25	40
Wetlands	90	40	50
Green roofs	Volume reduction only	Volume reduction only	Volume reduction only
Water tanks	Volume reduction only	Volume reduction only	Volume reduction only
Oil water separators	15	0	5

As an example, a stormwater management approach uses a swale to drain into a wetland to provide for water quality treatment for both sediment and nutrients from a road project.

$$R = A + B - [(A \times B)/100]$$

For sediment: $R = 70 + 90 - [(70 \times 90)/100] = 160 - 63 = 97\%$ removal

For nitrogen: $R = 20 + 40 - [(20 \times 40)/100] = 60 - 8 = 52\%$ removal

For phosphorus: $R = 30 + 50 - [(30 \times 50)/100] = 80 - 15 = 65\%$ removal

Obviously, the results depend on the removal rates of a given contaminant by a specific practice. The values given in Table 9-1 are relative values based on international literature. There will be local variation but the values can be considered approximate.

When using stormwater treatment practices in series, arrange the practices from upstream to downstream in ascending order of the contaminant removal ability. The lowest removal practice should be placed upstream of the higher removal practice.

9.5 Flow and treatment control

Specific design guidance is provided in this Section for the following practices:

- Swales
- Filter strips
- Sand filters
- Rain gardens
- Infiltration

- Wet ponds
- Wetlands
- Green roofs
- Water tanks
- Oil and water separators

These practices are seen as applicable for new development.

Prioritisation of this list is difficult as each practice has value, but one or more may be more appropriate in a given catchment. For example, swales, filter strips, sand filters, rain gardens and oil and water separators are primarily water quality practices with limited ability to address water quantity issues.

Wet ponds and wetlands can provide good water quantity control but wet ponds have a limited ability to remove hydrocarbons and soluble metals.

One practice that is good for both water quantity and water quality control is wetlands. Their organic substrate, density of vegetation and ability to provide live storage for water quantity control makes them suitable for both water quantity and water quality control. The major drawbacks of wetlands are their occupation of space and the need to have a catchment area large enough to support hydric soils, but they should be considered whenever peak control or stream erosion protection is a project component.

9.5.1 Swales

Description: Vegetated swales are designed and constructed to capture and treat stormwater run-off through:

- Filtration
- Infiltration
- Adsorption, and
- Biological uptake



Swales are a very appropriate practice for roads and new development. They can easily occupy a linear corridor without taking up much additional space. They can also take the place of conventional stormwater conveyance systems. Although swales may vary in their purpose in different areas, their overall objective is to slow stormwater flows, capture contaminants and possibly reduce the total volume of stormwater run-off.

Water quality treatment can be provided by passing stormwater flows through vegetation. Passage through vegetation and providing contact with organic matter allows physical, chemical and biological processes to occur that reduce contaminant delivery downstream.

Stormwater Management Function	
	Water quality
<input checked="" type="checkbox"/>	✓ Metals
<input checked="" type="checkbox"/>	✓ Sediment
	~ TPH
<input type="checkbox"/>	x Flood protection
<input type="checkbox"/>	x Stream channel erosion protection

A key factor in vegetated swale water quality performance is the residence time that the water takes to travel through the swale. Residence time depends on the following items:

- The longitudinal slope of the swale;
- The cross-sectional area of the swale; and
- Velocity of the flow.

The velocity of flow is a function of the flow area, slope and frictional resistance of the vegetation and a common equation for calculating velocity is Manning's Equation.

$$V = R^{0.67} s^{0.5} / n$$

Where:

- V = Average velocity in m/s
R = The hydraulic radius of the swale in metres
s = Slope of the swale in m/m
n = Manning coefficient of roughness

Residence time can then be determined by the following equation:

$$t = L/V$$

Where:

- t = Residence time in minutes (divide result by 60 s/m)
V = Velocity of flow at the design rate of flow in m/s
L = Swale length in metres

(a) Basic design parameters

The following Table 9.2 should be used for swale design elements.

Table 9.2 Swale design elements.

Design parameter	Criteria
Longitudinal slope	< 5%
Maximum velocity	0.8 m/s for water quality storm
Maximum water depth above vegetation	The water quality design water depth should <u>not</u> exceed design height for grass. This is a key criterion for ensuring Manning roughness coefficient is provided
Design vegetation height*	100-150 mm
Manning coefficient	0.25 for WQ storm, 0.03 for submerged flow (ten-year storm)
Maximum bottom width	2 m
Minimum hydraulic residence time	9 minutes
Minimum length	30 m
Maximum catchment area served	4 ha

Design parameter	Criteria
Maximum lateral slope	0%
Maximum side slope	4 H:1V (shallow as possible for mowing purposes)
Where longitudinal slope < 2%	Perforated underdrains shall be provided
Where longitudinal slope > 5%	Check dams shall be provided to ensure effective slope < 5%
Where concentrated flows enter the swale (from pipes)	Level spreaders shall be placed at the head of the swale to disperse flows
Ten-year storm velocities	< 1.5 m/s unless erosion protection is provided
* This applies to normal grasses. Other vegetation, such as oioi can provide improved performance with reduced maintenance frequency.	

There are several points that need some discussion and they include:

- Residence time.
- Manning's coefficient of roughness.
- Lateral inflow.

(b) Residence time

There have not been many studies that relate water quality performance in swale design. The most recognised work has been done in the U.S. (Metropolitan Seattle, 1992). That study recommended a residence of nine minutes for flow to pass through the swale and provide approximately an 80+% removal of total suspended solids. Most governmental agencies in the U.S. have adopted that criterion. More recently, the recommendation has been recommended upward to 22 minutes due to the uncertainty of performance (Washington State Department of Ecology, 2001). That change in residence time is a significant change from the nine-minute criterion but it is not recommended that the time be increased until further investigation of swale performance is done in New Zealand.

Residence time is seemingly more important for sediment reduction than it is for nutrient reduction. Investigations in Brisbane (Fletcher, *et. al*, undated) have indicated that concentrations of TSS continue to decrease over swale length and do not reach an asymptote. For TP and TN, however, there is a very rapid decrease in concentration within the first quarter of the swale length, after which a relatively constant concentration is maintained. For phosphorus the indication may relate to a high cation exchange capacity of the underlying silty-clay soils while for TN, the rapid initial decline in concentration suggests a rapid process such as soil sorption or adsorption.

(c) Manning's coefficient of roughness

Determining roughness coefficients is more art than science. Many design handbooks provide one value for Manning's coefficient of roughness of 0.2 (Metropolitan Seattle, 1992) or 0.25 (California Stormwater Quality Association, 2003). The ARC funded a swale study (Larcombe, 2003) where dye tests were done on a swale to determine "n" by measuring flow times through the swale. In all of the test trials the values of Manning's coefficient of roughness varied from 0.18-0.30. In reality the range is very consistent with the recommendations provided in the literature. The ARC recommended a series of equations for determination of "n" and using those equations provides values lower than Larcombe found in his study.

It is recommended that a standardised value for Manning's coefficient of roughness be set at 0.25. It is a mid-point in the Larcombe study and agrees favourably with the California recommendation. It is not felt that using the equations would provide necessarily a better result in design.

For the ten-year storm analysis, it is assumed that the vegetation is submerged so the coefficient of roughness is reduced accordingly. The value selected is 0.03 (Chow, 1959).

(d) Lateral inflow

A common concern with swales is lateral inflow from site areas to a point where the flow does not achieve the nine-minute residence time. To the degree that the nine minutes can be attained it should be. An example of this is Figure 9.1 that, in addition to check dams, shows a lateral flow diversion that directs the lateral flow to the head of the swale.

Where lateral inflow cannot meet the nine-minute residence time for part of the alignment, the normal approach is to accept that the average flow through the swale does take nine minutes. There will be areas in the upper part of the swale that may exceed the required residence time so the average is appropriate in light of the benefits that swales provide.

Figure 9.1 - Swale with check dams and diversion of lateral inflow

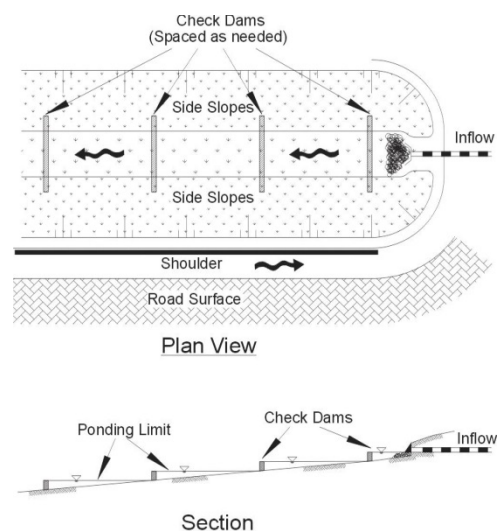

(e) Detailed design procedure

The design approach takes the designer through a series of steps that consider swale performance for water quality treatment and consideration of larger flows to ensure that scour or re-suspension of deposited sediments does not occur.

- (i) Estimate run-off flow rate from the water quality storm. Use the two-year one-hour storm as the water quality storm and use the rational formula for calculation of flows. One difference between swale and filter strip design and other stormwater management practices is that they are designed by flow rate, which is why the two-year one-hour storm is used in lieu of the 90% storm. Other practices are designed by calculation of the water quality volume.

- (ii) Establish the longitudinal slope of the swale.
- (iii) Select a vegetation cover. It should be grass and would generally be either perennial rye or fescue.
- (iv) The value for Manning's coefficient of roughness is 0.25.
- (v) Select a swale shape. Two shapes are proposed as they ensure distributed flow throughout the bottom of the swale. Triangular swales are not recommended as they concentrate flow at the bottom of the swale. Channel geometry and equations for calculating cross-sectional areas and hydraulic radius are provided under the individual configurations in Figure 9.2.

(f) An assumption is made on the depth of flow in the swale for the water quality storm. This assumed depth is used for calculating the bottom width of the swale and cross-sectional area.

(g) Use Manning's equation for calculating dimensions of the swale by using first approximations for the hydraulic radius and dimensions for selected shape.

$$Q = AR^{0.67}s^{0.5}/n$$

By making some assumptions about depth and width ratios such as the hydraulic radius for a trapezoid approximating the depth (d), the bottom width of a trapezoid (b) equals the following:

$$b = (Qn/d^{1.67}s^{0.5}) - Zd$$

The slope, depth, discharge and side slope are all known and b can be determined.

Where:

- Q = Design discharge flow rate (m³/s)
- n = Manning's n (dimensionless)
- s = Longitudinal slope (m/m)
- A = Cross-sectional area (m²)
- R = Hydraulic radius (m)
- T = Top width of trapezoid/parabolic shape (m)
- d = Depth of flow (m)
- b = Bottom width of trapezoid (m)

For a parabola, the depth and discharge are known so the top width can be solved for.

(h) Knowing b (trapezoid) or T (parabola), the cross-sectional area can be determined by the equations in Figure 10.2.

Figure 9.2 - Channel geometry

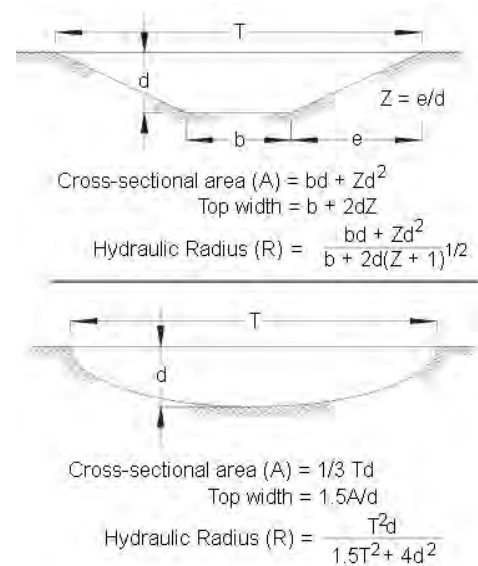

- (i) Calculate the swale velocity from the following equation:

$$V = Q/A$$

If $V > 0.8$ m/s repeat steps 1-9 until the velocity is less than 0.8 m/s.

- (j) Calculate the swale length (L in metres)

$$L = Vt \text{ (60 s/minute)}$$

Where t = residence time in minutes.

- (a) Flows in excess of the two-year one-hour storm

It is expected that run-off from events larger than the design storm will go through the swale. In that situation, a stability check should be performed to ensure that the ten-year, one-hour storm does not cause erosion. For the ten-year storm, flow velocities should not exceed 1.5 m/s, although higher velocities may be designed for with appropriate erosion protection. When considering larger storms consideration must be given to increased rainfall values as a result of climate change. Table 8.4 provides global warming design information.

- (b) Shallow slope situations

Where slopes are less than 2%, an under drain must be used to prevent soils from becoming saturated during wet times of the year. Figure 9.3 provides a typical cross section of the under drain system ensuring that water passes through the invert of the swale, through a loam soil, then geotextile fabric and gravel prior to discharge through a 100 mm perforated pipe.

Using an under drain can be one method to meet extended detention requirements. In this case, the extended detention volume can pass through the permeable soil with an assumption of total drainage time being 24 hours.

Figure 9.3 - Swale schematic showing soils and underdrain

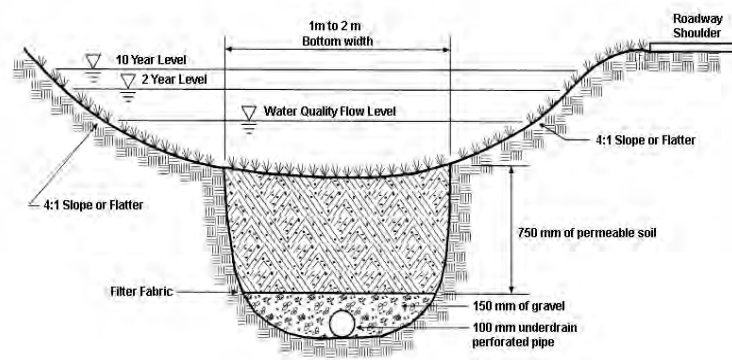

(c) Vegetation

For the most part, vegetation will consist of either perennial rye or fescue grass. There may be other forms of vegetation that would provide comparable or improved treatment effectiveness with less maintenance requirements. One type of grass is oioi (*Apodasmia similis*) that is a very dense grass that grows by rhizome and can become a thick filter media that you do not want to mow. The adjacent picture shows an oioi swale at the Auckland Botanic Gardens being constructed.

Oioi vegetation being placed in a stormwater treatment swale to promote metals uptake and have a reduced maintenance requirement



9.5.2 Case study

Project description

A small residential development in Rotorua is proposed with its expected imperviousness being 50%. The development is one hectare in size with average lot sizes being 500 m². Pre-development land use was a pasture and the slope is between 2-7%. The site has been graded to have ½ of the site drain to the front and ½ of the site to drain to the rear of the property. So, there are two swales, each servicing 0.5 ha.

Hydrology

Using the rational formula:

$$C = 0.45$$

$$Q_{wq} = 0.00278 CIA$$

$$I = \text{Rainfall intensity (mm/hr)} = 23.3 \text{ mm}$$

$$A = \text{Catchment area in hectares (ha)}$$

$$Q_{wq} = 0.00278(0.45)(23.3)(0.5) = 0.015 \text{ m}^3/\text{s}$$

For Q10 one-hour storm rainfall is 33.3 mm and Manning's coefficient of roughness is 0.03 for flow elevations above vegetation height. Effect of global warming on the ten-year storm is 15.5% increase in rainfall. So 33.3 mm for a ten-year storm increased by 15.5% results in 38.46 mm of rainfall.

$$Q_{10} = 0.00278(.45)(38.46)(0.5) = 0.024 \text{ m}^3/\text{s}$$

Swale design

$$\text{Slope of swale alignment} = 0.015$$

Several assumptions have to be made regarding the swale, first of which is that the swale will have a trapezoidal design. Side slopes (Z) will then be recommended and an assumption of design storm depth should be made. That value may change depending on the velocity of flow being less than 0.8 m/s.

For this case study, $Z = 4$ and the depth of flow = 100 mm, which is also the design height of the grass.

Based on the value for Q and s , and the assumptions for n and d , solve for the swale bottom width (b).

$$b = (Qn/d^{1.67}s^{0.5}) - Zd$$

$b = ((.014)(.25)/(.1^{1.67})(.015^{0.5})) - (4)(.1) = 0.95$ m. If the swale width had exceeded 2 m, the depth of vegetation could have been increased to 150 mm as long as the grass could remain standing during storm flow.

Calculate the top width:

$$T = b + 2dZ = 0.95 + 2(.1)(4) = 1.75$$
 m

Calculate the cross-sectional area:

$$A = bd + Zd^2 = (0.95)(.1) + 4(.1^2) = 0.135$$
 m²

Calculate the flow velocity:

$V = Q/A = 0.014/0.135 = 0.1$ m/s which is well under than the 0.8 m/s maximum - good.

Calculate the swale length:

$$L = Vt = 0.1 (540 \text{ s}) = 43.2$$
 m

As the swale will probably have larger flows pass through it, the swale design can be adjusted to account for the larger flows. In this situation the Manning coefficient of roughness will have to be decreased, as flow will be above the grass height so assume $n = .03$ as the vegetation is completely submerged. Solve for d and ensure that velocities are not erosive. $Q_{10} = 0.024$ m³/s.

The following Table 9.3 relating flow depth to Manning's n to discharge provides information on swale flow under larger flow conditions.

Table 9.3 Flow Depth vs. Manning's n versus Discharge.

Flow depth (m)	Manning's n	Discharge (m ³ /s)
0.1	0.25	0.02
0.1 - 0.15	0.03	0.084
Total Discharge		0.1

Even adding only 50 mm to the swale depth provides for conveyance of the ten-year event. In terms of ensuring that the velocity is not greater than 1.5 m/s.

$Q = AV$ or $Q/A = V = 0.024 \text{ m}^3/\text{s}/0.39 = 0.06$ m/s so the velocities during the ten-year storm are non-erosive.

As the project is in Rotorua, a combination of practices should be used. The swale has a nitrogen removal percentage of 20% and 30% for phosphorus. On this site it is recommended that a rain garden having an anaerobic zone be used with the swales draining into the rain gardens.

Using this approach will provide the following removals of sediments and nutrients.

$$R = A + B - [(A \times B)/100]$$

For sediment: $R = 70 + 90 - [(70 \times 90)/100] = 97\%$ removal

For nitrogen: $R = 20 + 50 - [(20 \times 50)/100] = 60\%$ removal

For phosphorus: $R = 30 + 80 - [(30 \times 80)/100] = 76\%$

9.5.3 Filter strips

Description: Filter strips are uniformly graded and densely vegetated to treat stormwater run-off by the following:

- Filtration
- Infiltration
- Adsorption, and
- Biological uptake



The major difference between swales and filter strips is that swales accept concentrated flow while filter strips accept flow as distributed or sheet flow. Filter strip performance also relies on residence time that stormwater flows take to travel through the filter strip and the depth of water relative to the height of vegetation. Good contact with vegetation and soil is required to promote the operation of the various mechanisms that capture and transform contaminants, so spreading flow in minimal depth over a wide area is essential.

Stormwater Management Function	
✓	Water quality
	✓
	Metals
✓	Sediment
	TPH
~	
x	Flood protection
x	Stream channel erosion protection

They are well suited for treating run-off from small impervious surfaces and for use as a pre-treatment device for other practices such as a sand filter or wetland.

A key element of filter strips is that they rely on vegetation to slow run-off velocities. If stormwater run-off is allowed to concentrate, it effectively short-circuits the filter strip and reduces water quality benefits. As used in this guideline, filter strips are simple designs that must withstand the full range of storm events without eroding.

Basic design parameters

The following Table 9.4 should be adhered to in designing a filter strip.

Table 9.4 Filter Strip design elements.

Design parameter	Criteria
Longitudinal slope	2-5%
Maximum velocity	0.4 m/s for water quality storm
Maximum water depth above vegetation	The water quality design water depth should <u>not</u> exceed ½ of the design height for grass. This is a key criterion for ensuring Manning roughness coefficient is provided

Design parameter	Criteria
Design vegetation height	100-150 mm
Manning coefficient	0.35 for WQ storm, 0.03 for submerged flow (ten-year Storm)
Minimum hydraulic residence time	9 minutes
Minimum length	Sufficient to attain residence time
Maximum catchment area served	2 ha
Maximum lateral slope	2%
Where longitudinal slope < 2%	Filter strips are not recommended for slopes less than 2% unless they are designed for infiltration of run-off
Where longitudinal slope > 5%	Level spreaders shall be provided to ensure effective slope < 5%
Maximum overland flow distance uphill of the filter strip	23 m for impervious surfaces
Where concentrated flows enter the swale (from pipes)	Flows entering a filter strip cannot be concentrated. If this is the situation, level spreaders must be used to disperse flows
Ten-year storm velocities	< 1.5 m/s unless erosion protection is provided

To be effective, filter strips require sheet flow across the entire strip. Once flow concentrates to form a channel, it effectively short-circuits the filter strip. Unfortunately, this usually occurs within a short distance for filter strips in urban areas. It is difficult to maintain sheet flow over a distance of 45 m for pervious areas and 23 m for impervious areas. This may be due in part to the inability to obtain evenly compacted and level soil surfaces using common construction methodology. For some applications, a level spreader can be used to help ensure even distribution of stormwater onto the filter strip.

(a) Detailed design procedure

A schematic of a filter strip is shown in Figure 9.4. The schematic shows a collection trench and a level spreader if the flow is from a pipe. In this situation the dispersed flow is maintained across the width of the filter strip.

(b) Design approach

The first step is to calculate the discharge (Q) for the area draining to the filter strip. If the filter strip is to take run-off only from impervious surfaces, the easiest way to determine the discharge is to use the rational equation $Q = CIA$ in an identical approach as was done in the swale design approach.

Figure 9.4 - Schematic of a filter strip

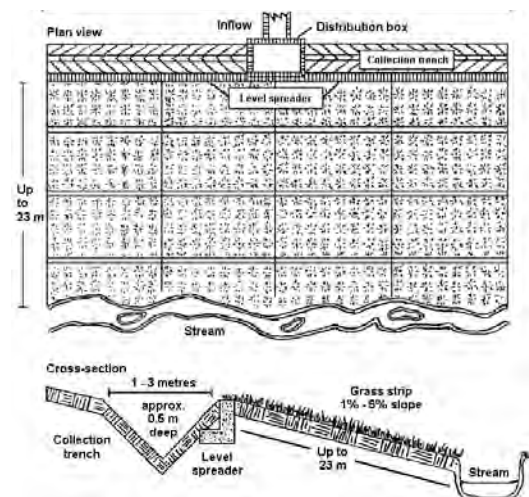

Once the peak discharge is determined, that discharge can be entered into Manning's equation to determine the width of the filter strip.

$$Q = AR^{2/3}S^{1/2}/n$$

Where:

A = width of filter strip x depth of flow (determined by design grass height)

W = width of filter strip in metres

R = depth of flow (due to very wide flow)(in metres)

d = depth of flow in metres = R

s = slope

n = roughness coefficient (0.35)

w is known from individual site conditions so $d = (Qn/ws^{5})^{.6}$

Solve for d based on knowing other design parameters and d must be less than 50 mm in depth

$Q = VA$ where $A = w \times d$ so velocity of flow can be determined

Once velocity is determined the length of filter strip can be determined by

$$L = Vt$$

Where:

L = length in metres

V = velocity in m/s

t = time in seconds (540 seconds for 9 minute residence time)

9.5.4 Case Study

(a) Project description

A small road project is being constructed in Te Puke with a filter strip to treat the road run-off. The two-year one-hour storm depth is 25.8 mm. The slope of land adjacent to the road is 3% and the road is 500 m with a crown in the centre so the portion of road draining to the filter strip is 3.6 m wide (1,800 m²).

(b) Hydrology

Using the Rational Formula:

$$Qwq = 0.00278 CIA$$

$$C = 0.85$$

$$I = 25.8 \text{ mm}$$

A = Catchment area in hectares

$$Qwq = 0.00278(0.85)(25.8)(0.18) = 0.011 \text{ m}^3/\text{s}$$

For the ten-year storm, the effect of global warming is predicted to be 15.5% increase in rainfall. So, design rainfall for the ten-year storm = 44 mm.

$$Q_{10} = 0.00278(.85)(44)(0.18) = 0.02 \text{ m}^3/\text{s}$$

(c) Filter strip design

$$Q = AR^{0.67}s^{0.5}/n$$

Where:

Q = Water quality discharge (m³/s)

A = Area of filter strip = (w - width in m)(depth of flow - d - in m)

R = 0.03 m based on water quality storm and very wide flow path

s = .03

n = .35

The width is given based on site conditions (75 m) so solve for y and ensure that it is less than 0.05 m.

$$d = (Qn/ws^{.5})^{.6}$$

You will know "w" based on local site conditions. For this example, assume w = 75 m.

$$d = (.011(.35)/75(.03)^{.5})^{.6}$$

d = 7.6 mm which is well under the maximum of 50 mm

Calculate the flow velocity:

V = Q/wd = .011/75(.0084) = .02 m/s which is well under the maximum 0.4 m/s allowed.

Calculate the length of the filter strip:

$$L = Vt = .02(540) = 10.8 \text{ m in length.}$$

As can be seen from this example, the filter strip width can be reduced substantially to adjust to site conditions. The two key elements are a maximum depth of flow during the two-year one-hour storm of 50 mm and a residence time of at least 9 minutes (540 seconds) to establish the length of the filter strip.

In terms of a two or ten-year storm, the main concern is that velocities of flow not exceed 1.5 m/s. Going through an analysis of the ten-year storm (worst case scenario).

$$Q_{10} = 0.02 \text{ m}^3/\text{s}$$

Again using Manning's equation:

Q = AR^{0.67}s^{0.5}/n and solve for d through the equation:

$$d = (Qn/ws^{.5})^{.6}$$

As the depth of flow still does not exceed the grass height the same n factor will be used. If the width of the filter strip were smaller and the depth of flow would exceed the design grass height an appropriate roughness coefficient to be used would be n = 0.15.

$$d = (.02(.35)/75(.03)^{.5})^{.6}$$

d = 0.01 m

Using the value to ensure that the velocity of flow during a ten-year storm will not exceed 1.5 m/s.

$$V = Q/wd = 0.02/75(.01)$$

$V = 0.03$ m/s which is well under an erosive velocity.

As the project is in Te Puke, a combination of practices for additional sediment removal does not need to be used. The filter strip has a suspended solids removal percentage of 80%.

9.5.5 Sand filters

Description: Sand filters are designed and constructed to capture and treat stormwater run-off through:

- Sedimentation
- Filtration
- Volatilisation
- Adsorption, and
- Biological processes



Sand filters use filtration for treating stormwater run-off. They are similar to biofiltration in that stormwater passes through a filtering media such as sand, gravel, compost or peat to filter out contaminants. They are especially suited for small catchment areas and are primarily water quality treatment practices having little water quantity benefit.

Sand filters have been used to treat stormwater run-off for years, mainly as a result of sand filter effectiveness at removal of hydrocarbons. They are very suitable in ultra-urban environments where space is limited but are also used where more space is available in a similar fashion to ponds.

As they are so effective at removal of finer sediments, they are prone to clogging and require maintenance on a more frequent basis than a practice such as wetlands. They are primarily used for high percentages of impervious surfaces where the majority of sediments are in the coarse fraction.

Basic design parameters

Sand filters should have a forebay (or sedimentation chamber) where coarser sediments would be captured and a filtration chamber, having an underdrain, for removal of finer sediments and hydrocarbons. A major component of a sand filter is live storage above the sediment/filtration chambers for storage of stormwater until the water can soak through the sand.

The following schematics provide a visual indication of how sand filters can be designed. They can be constructed similarly to ponds as shown in Figure 9.5, or an underground vault as shown in Figure 9.6 or as a linear filter as shown in Figure 9.7.

Stormwater Management Function	
	Water quality
<input checked="" type="checkbox"/>	Metals
<input checked="" type="checkbox"/>	Sediment
<input checked="" type="checkbox"/>	TPH
<input type="checkbox"/>	Flood protection
<input type="checkbox"/>	Stream channel erosion protection

The treatment process is the same for all three of the practices, but Figure 9.5 allows for peak flow control in addition to water quality treatment. The other two figures provide water quality control only.

Figure 9.5 - Sand filter basin

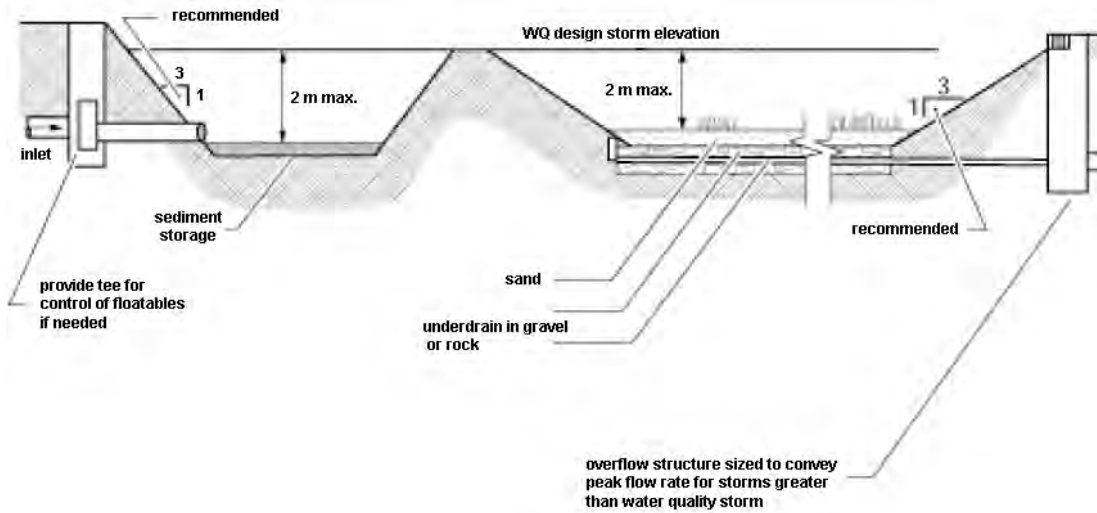

Figure 9-6 - Vault sand filter

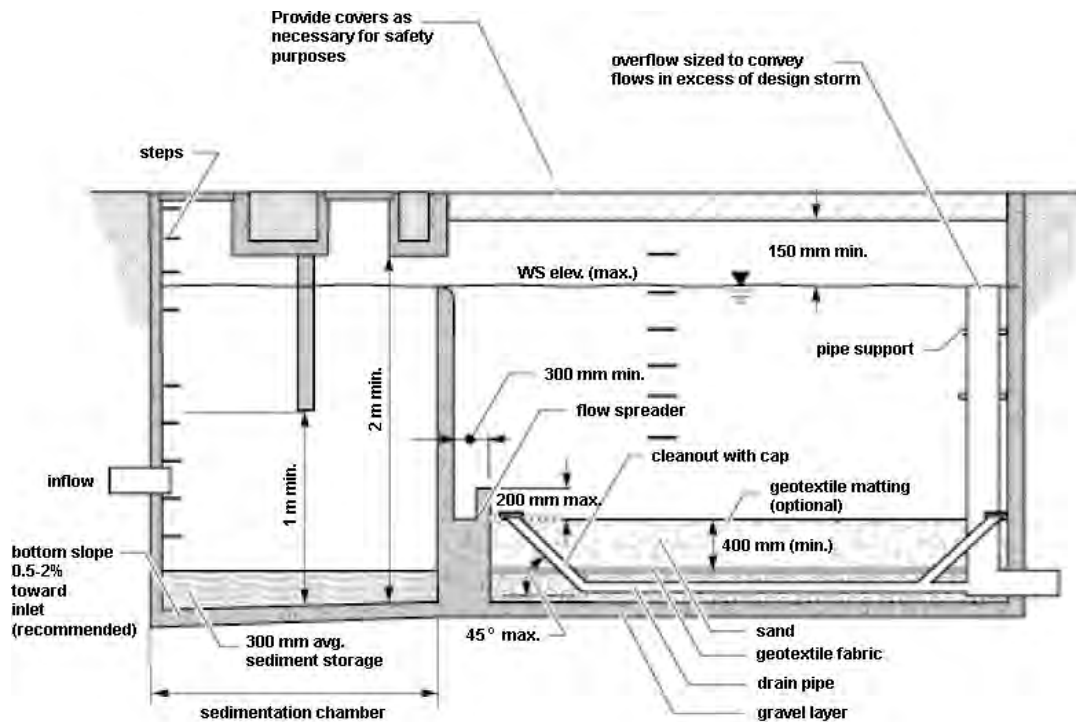
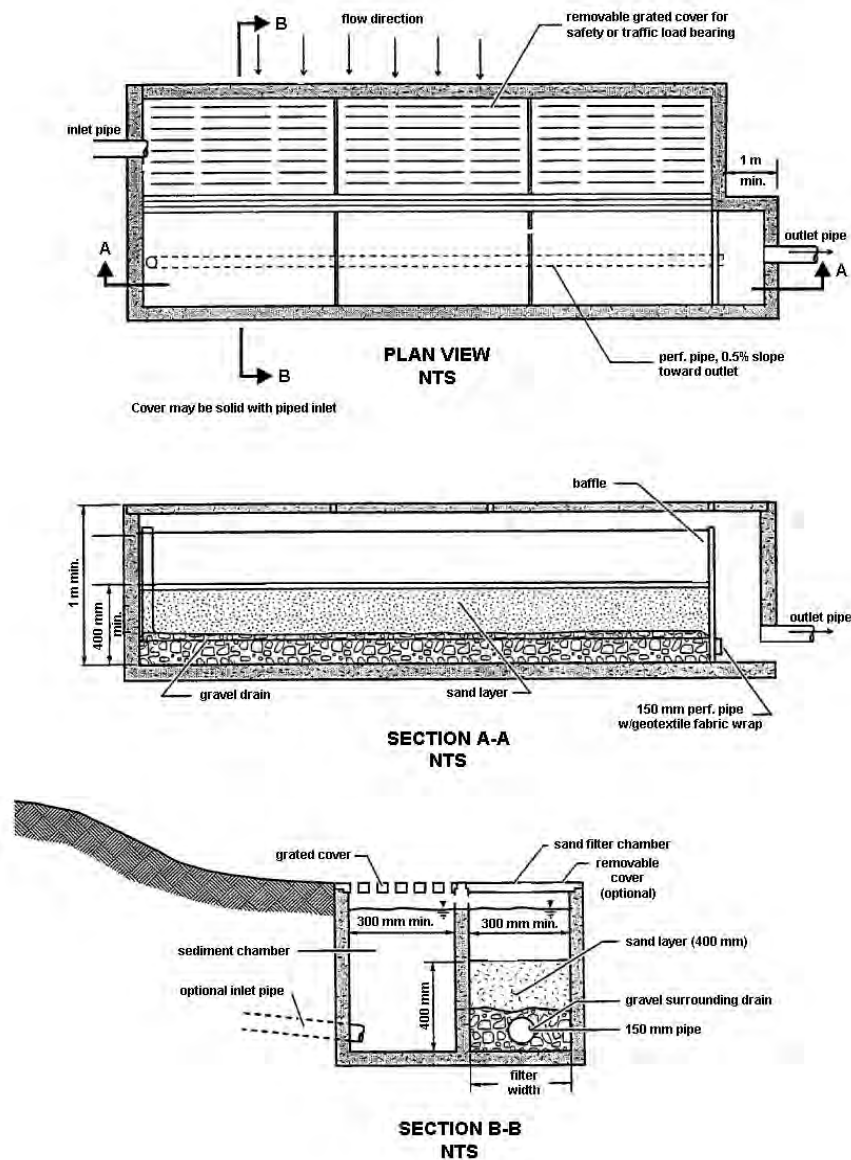

Figure 9.7 - Linear sand filter



An important consideration of sand filter performance is the diversion of larger flows around the filter. Having high flows enter the filter with an overflow in the filter will significantly reduce performance, as turbulent flow will allow for finer sediments to pass over the filter bed. In a similar fashion, hydrocarbons having a specific gravity less than water will pass over the filter into the overflow pipe.

A simple way to prevent contaminants from exiting the filter is to have a flow diversion structure placed prior to the sand filter. This is a simple design, especially when the flow into the filter is through a pipe. Figure 9.8 provides a schematic of how the flow diverter can be designed so that the water quality storm passes through the sand filter and larger flows bypass it. Figure 9.9 shows how the system is placed schematically.

Most street and road particulate matter is in coarser fractions. However, most stormwater contaminants are associated with fine particles. As sand filters have two chambers, the sedimentation chamber will remove the coarse sands and gravels while the filtration chamber will remove the finer silts and clays.

Figure 9.8 - Diversion weir

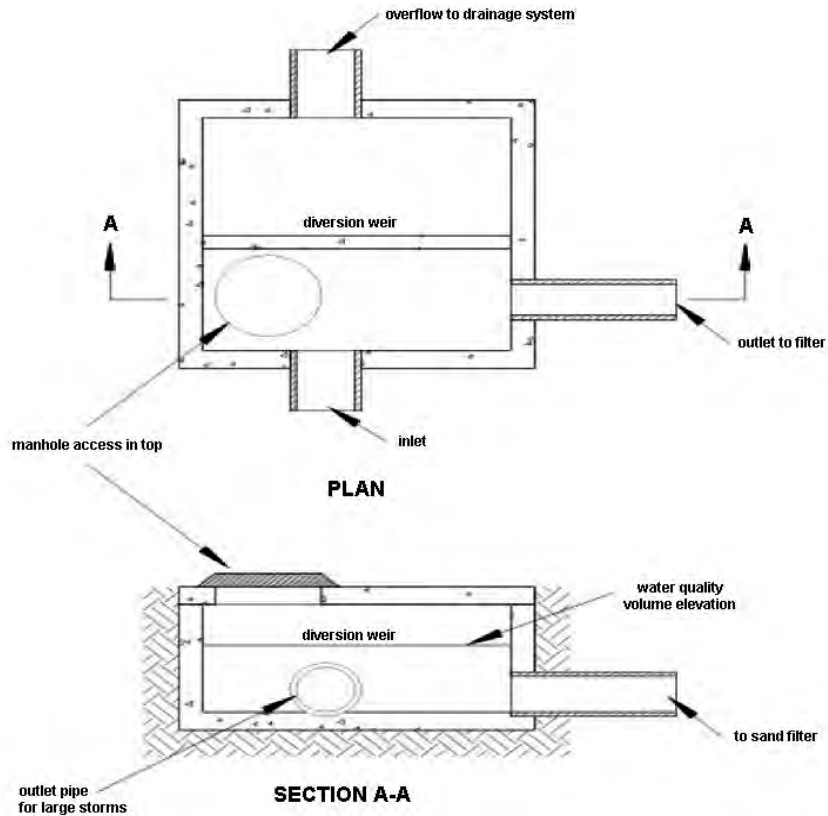
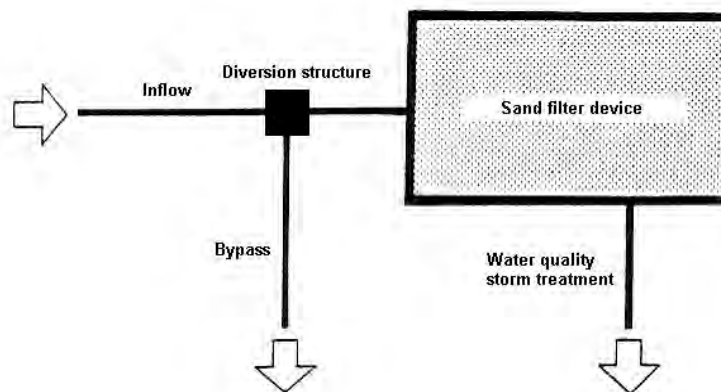

Figure 9-9 - Large flow bypass schematic



Detailed design procedure

Design approach

Calculate the water quality volume to be treated by using the 90% storm (two-year one-hour).

Calculating the water quality volume is done by the following two calculations:

$$A_{wq} = 0.9(\text{imp. \%}/100) \times \text{total site area} + 0.15 (\text{pervious \%}/100) \times \text{total site area}$$

Where total site area = m^2

The water quality volume $V_{wq} = (\text{two-year one-hour rainfall in metres}) A_{wq}$

A minimum of 37% of the water quality volume must be available as live storage to ensure that the water quality volume passes through the filter without bypassing. The sand filtration chamber is sized by a variation of Darcy's Law.

$$A_f = V_{wq}d_f/k(h+d_f)t_f$$

Where:

- A_f = surface area of sand bed (m^2)
- V_{wq} = water quality volume
- d_f = sand bed depth (m)
- k = coefficient of permeability for sand (m/day)
- h = average depth of water (WQ storm) above surface of sand (m)
($\frac{1}{2}$ maximum depth)
- t_f = time required for run-off to pass through the filter (days)

The following values should be used:

- t_f = 2 days (maximum)
- k = 1 m/day
- d_f = 0.3 m (minimum)

Several points should be discussed regarding the values that should be used:

- Time required to pass the water quality storm.
- The permeability rate selected.
- Time required passing the water quality storm.
- There are several reasons why this value was selected.

Having two days as a limiting value will ensure that the volume is available for the next storm. It should be recognised that these are averages and some fluctuation will occur.

Having the system drain within a two-day period will prevent the development of biofilms on the surface of the sand, which would reduce permeability rates.

Permeability rate

This is an issue that has controversy associated with it. Sand has a high permeability rate (Table 6-1 in Section 6) and the value selected is very low. Experience has shown that the initial high permeability rate rapidly reduces when contaminated stormwater run-off passes through the sand. The rate reduces to a level where it stabilises for a period of time before complete clogging occurs. The value generally accepted internationally is approximately one m/day.

- 1 Size the sedimentation chamber with the following points in mind.
 - Inflow into the chamber must not cause re-suspension of previously deposited sediments.
 - The sedimentation chamber outlet must deliver flow to the filtration chamber as sheet flow.
 - The sedimentation chamber must be at least 25% of the filtration area.

- Flow velocities in the sedimentation chamber are required to be below 0.25 m/s.
- The sedimentation chamber must have a permanent pool with a minimum depth of 400 mm to reduce potential for sediment re-suspension.
- The sedimentation chamber should be configured to avoid short circuiting of flow.

The sand specifications are the following as provided in table 9.5.

Table 9.5 Sand specifications.

Sieve size (mm)	Percentage passing
9.5	100
6.3	95-100
3.17	80-100
1.5	50-85
0.8	25-60
0.5	10-30
0.25	2-10

There will be some variation in sand grades from the specified grades. However, a number are close to the lower limit and can be used. It is important to meet as closely as possible the specified limits as coarser aggregate will allow for more contaminate migration and finer aggregate will clog more quickly.

Recent work done by the Facility for Advancing Water Biofiltration (FAWB) in Australia has indicated excellent TSS and metals removal with soil and sand-based filters that are non-vegetated (FAWB, 2008). Thus, it can be recommended that metals and sediments in the Bay of Plenty region could be effectively removed from stormwater discharges using sand filtration. A key element in the conclusion is that wetting and drying are key elements in treatment.

An under drainage system shall be provided. The system will normally consist of perforated lateral pipes (150 mm diameter) that are placed in the gravel or stone layer that is under the sand. The depth of the gravel layer shall be at least 200 mm in depth with filter fabric between the gravel and sand to prevent migration out of the system.

9.5.6 Case study

Project description

It is the intention to construct a parking lot in Whakatāne having a surface area of approximately 3,000 m².

Hydrology

- 1 The water quality storm is 24 mm.
- 2 Calculate the water quality volume to be treated.
 $A_{wq} = 0.9 (\text{imp. \%}/100) \times \text{total site area} + 0.15(\text{pervious \%}/100) \times \text{total site area}$

Where total site area = m^2

$$A_{wq} = 0.9 (100\%/100) \times 3,000 + 0.15 (0\%/100) \times 3,000 = 2,700 \text{ m}^2$$

The water quality volume $V_{wq} = 0.024 A_{wq}$

$$V_{wq} = .024 (2,700) = 64.8 \text{ m}^3$$

Sand filter design

- 1 Live volume of storage needed $V_l = .37 (64.8 \text{ m}^3) = 24 \text{ m}^3$
- 2 Sand filter surface Area - Assume that max. head, $h_p = 1 \text{ m}$ so $h = 0.5 \text{ m}$

$$A_f = V_{wq} d_f / k(h + d_f) t_f$$

We know the following:

$$V_{wq} = 64.8 \text{ m}^3$$

$$d_f = 0.3 \text{ m}$$

$$k = 1 \text{ m/day}$$

$$h = 0.5 \text{ m}$$

$$t_f = 2 \text{ days}$$

$$A_f = (64.8)(0.3) / 1(0.5 + 0.3) 2$$

$$A_f = 12.2 \text{ m}^2$$

- 3 Size sedimentation chamber has to have at least 25% of the surface area of the filter area = 3.05 m^2 . In reality it has to be larger due to the need to provide 37% live storage. If the designs live depth of storage is one metre then the volume above the combined filtration and sedimentation areas is 15.25 m^3 .

Since the required live storage is 24 m^3 then the combination of live storage in both the sediment chamber and filtration chamber must be increased by 8.75 m^3 . The designer can determine where that additional volume must be obtained, which could possibly include the pipe system draining to the filter.

As the project is in Whakatāne, a combination of practices for additional sediment removal does not need to be used. The filter strip has a suspended solids removal percentage of 80%.

9.5.7 Rain gardens

Description: Rain gardens are designed and constructed to capture and treat stormwater run-off through:

- Sedimentation
- Filtration
- Infiltration (depending on soils)
- Adsorption, and
- Biological processes



Rain garden is a common term that is used internationally to describe the storage, passage and eventual discharge of stormwater to a receiving system. Two other terms are commonly used for rain gardens and they are:

- Bioretention
- Biodetention

Bioretention is a description of a process whereby stormwater run-off is treated by passing the water through a soil media and then either evapotranspiring the water or infiltrating that water into the ground.

Biodetention is the passage of water through a filter media and then discharging that water downstream to surface waters.

Rain gardens operate by filtering stormwater run-off through a soil media prior to discharge into either the ground or a drainage system. The major pollutant removal pathways within rain gardens are (Somes and Crosby, 2008):

- Event processes
 - Sedimentation in the extended detention storage, primary sediments and metals;
 - Filtration by the filter media, fine sediments and colloidal particles; and
 - Nutrient uptake by biofilms.
- Inter-event processes
 - Nutrient adsorption and pollutant decomposition by soil bacteria; and
 - Adsorption of metals and nutrients by filter particles.

To retain the filter media within the rain garden and aid drainage, one or more layers are used at the bottom of the filter. The surface of most rain gardens is planted with a range of vegetation. Figure 9.10 shows a schematic of a rain garden highlighting key elements and flow paths.

Stormwater Management Function

	Water quality	
	✓	Metals
	✓	Sediment
✓	✓	TPH
	~	Nutrients
	~	Possibly through specific design
x		Flood protection
x		Stream channel erosion protection

Figure 9.10 - Schematic of rain garden key elements and flow paths
(Diagram courtesy of City of Kingston, Melbourne, Australia)

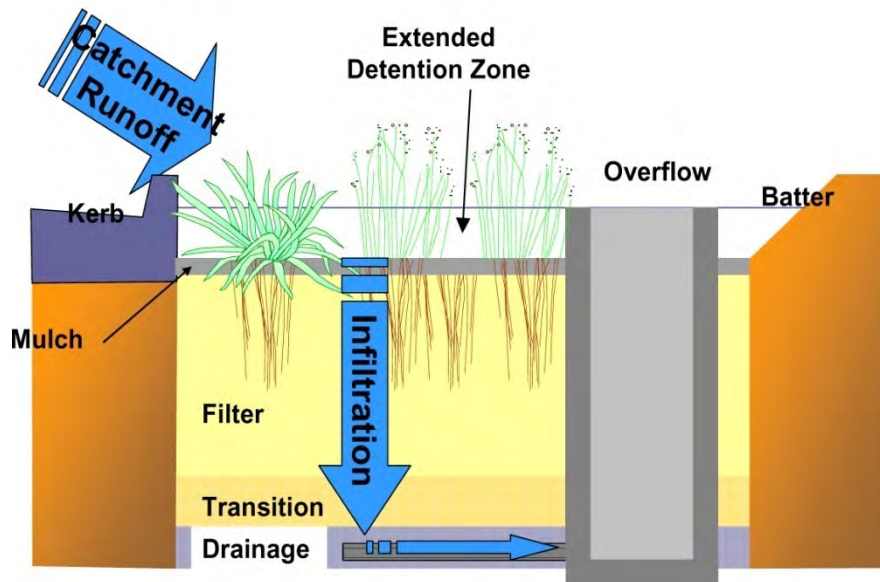

Rain garden design, as shown in Figure 9-10 differs only slightly from sand filter design. Where sand filtration relies on water quality treatment via passage of stormwater through sand, rain gardens incorporate plants and soils for removal of contaminants. A downside of the use of plants and soils rather than sand is a reduction in the permeability rate. This results in rain gardens being larger in surface area than sand filters.

Rain gardens have more aesthetic benefits not provided by sand filter systems and provide greater water quality benefits for a wider range of contaminants as a result of additional biological processes provided by plants and organic soils.

9.5.8 Basic design parameters

The main components of a rain garden include:

- Grass filter strip for minor pre-treatment (where space is available).
- Ponding area in the extended detention zone.
- Planting soils.
- Ground cover or mulch layer.
- Plant material.
- Underdrain system.

Depending on the natural soils in the area that the rain garden has been placed, final discharge of stormwater can be to ground or through a drainage system to surface waters. This will depend on the permeability rates of the underlying soil, depth to groundwater or bedrock and the stability of any slopes that the additional water may be discharged within. In the situation where the eventual disposal of stormwater is to ground, testing of infiltration rates needs to be done consistent with infiltration practices shown in the next section.

It is not recommended that geotextile filter cloth be used between the different media layers in the rain garden, as that will become a point of clogging in the filter.

Proper installation of the various layers of media (including drainage layer) will reduce potential migration of contaminants to the drainage system.

Rain gardens are designed as water quality practices and will generally not be used for water quantity control. If peak control is required and cannot otherwise be provided then consideration should be given to a constructed wetland that also provides peak control.

The presence of an anaerobic zone (made of sand or gravel with around 5% carbon source, such as woodchips) will improve nitrogen removal, by promoting denitrification. It will also enhance plant survival during drought periods, and reduce the risk of an “initial flush” of elevated nitrogen concentrations from the filter media after a prolonged dry period. An example of an anaerobic zone rain garden, as developed by Facility for Advancing Water Biofiltration (FAWB) is shown in Figure 9.11 (FAWB, 2008).

Figure 9-11 - Rain garden with an anaerobic zone (FAWB, 2008)

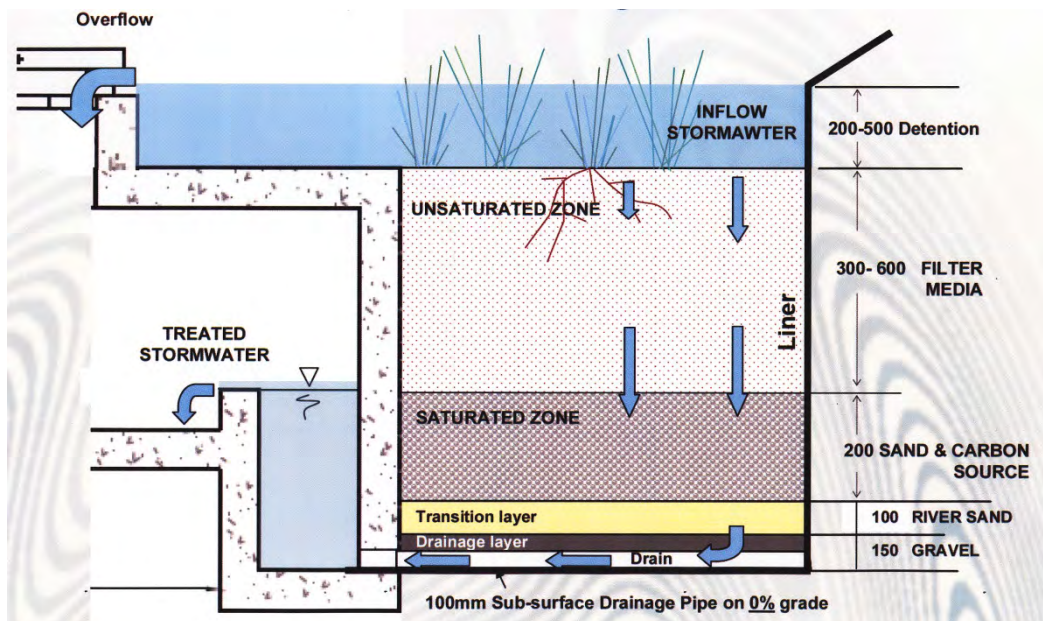

FAWB monitoring data from rain gardens having an anaerobic zone are shown in Table 9-1 but there is an improved nitrogen removal above conventional rain gardens of 50% versus 40% and an improved phosphorus removal of 80% versus 60%.

9.5.9 Detailed design procedure

Design approach

- 1 Determine the water quality storage volume using the 90% rainfall (two-year one-hour storm) level.
- 2 Minimum live storage provided above the soil media is 40% of the water quality volume to ensure that the entire water quality storm passes through the rain garden. Failure to provide the storage will result in system bypass and reduced water quality expectations.

3 Calculate the required surface area of the rain garden.

$$A_{rg} = (WQV)(d_{rg})/k(h+d_{rg})t_{rg}$$

Where:

- A_{rg} = Surface area of rain garden (m^2)
- WQV = Water Quality treatment Volume (m^3)
- d_{rg} = Planting soil depth (m)
- k = Coefficient of permeability (m/day)
- h = Average height of water (m) = $\frac{1}{2}$ maximum depth
- t_{rg} = Time to pass WQV through soil bed

The following values should be used:

- d_{rg} = 0.85 m
- k = 0.75 m/d
- h = 0.15 m (maximum water depth 300 mm)
- t_{rg} = 1.5 days

4 General comments on rain gardens

- If less depth of media must be used due to local constrictions (bedrock, groundwater) the area of storage must be increased so the same volume of storage in the media is maintained. The simplest way to ensure the storage volume is maintained is the following ratio:

$$A_{rev} = A_{rg}/d_{rev}$$

Where:

- A_{rev} = Revised surface area resulting from decreased depth
 - A_{rg} = Area of rain garden calculated in step 3 (m^2)
 - d_{rev} = Actual depth provided/0.85
- The coefficient of permeability will initially decline during the establishment phase, as the filter media settles and compacts, but this will level out and then start to increase as the plant community establishes itself and the rooting depth increases.
 - Keep drainage areas small and avoid sizing them for too large a catchment area. It is better to have more rain gardens than larger ones.
 - Place them in areas where they will not interfere with normal use of the property and where they don't interfere with sight lines, which may present safety issues.
 - Where possible, design them as off-line systems so that larger flows do not scour the surface of the rain gardens.

5 Composition of planting soil

FAWB has been investigating filter media for several years and has developed the following recommendations for the composition of planting soil (FAWB, 2008).

The bioretention filter media guidelines require three layers of media. The filter media itself (400-600 mm deep), a transition layer (100 mm deep) and a drainage layer (50 mm minimum) under drainage pipe cover.

The filter media is required to support a range of vegetation types (from groundcovers to trees) that are adapted to freely draining soils with occasional flooding. The material should be:

- Based on natural soils or amended natural soils and can be of siliceous or calcareous origin.
- In general, the media should be loamy sand with an appropriately high permeability under compaction and should be free of rubbish, deleterious material, toxicants, noxious plants and local weeds and should not be hydrophobic.
- The filter media should contain some organic matter for increased water holding capacity but low in nutrient content.

6 Determination of hydraulic conductivity

The hydraulic conductivity of potential filter media should be measured using the ASTM F1815-06 method. This test method uses a compaction method that best represents field conditions and so provides a more realistic assessment of hydraulic conductivity than other test methods.

7 Particle size distribution

Particle Size Distribution (PSD) is of secondary importance compared to hydraulic conductivity. A material whose PSD falls within the recommended range does not preclude the need for hydraulic conductivity testing. However, the following Table 9.6 provides a composition range for appropriate material specification.

Table 9.6 Composition range of filter media.

Material	Percentage of total composition	Particle size
Clay and silt	<3%	(<0.05 mm)
Very fine sand	5-30%	(0.05-0.15 mm)
Fine sand	10-30%	(0.15-0.25 mm)
Medium to coarse sand	40-60%	(0.25-1.0 mm)
Coarse sand	7-10%	(1.0-2.0 mm)
Fine gravel	<3%	(2.0-3.4 mm)

Clay and silt are important for water retention and sorption of dissolved contaminants; however they substantially reduce the hydraulic conductivity of the filter media. This size fraction also influences the structural stability of the material (through migration of particles to block small pores and/or slump). It is essential that the total clay and silt mix is less than 3% to reduce the likelihood of structural collapse of such soils.

The filter media should be well graded with all particle size ranges present from the 0.075 mm to the 4.75 mm sieve (as defined by AS1289.3.6.1-1995). There should be no gap in the particle size grading, and a small particle size range should not dominate the composition.

8 Soil properties

Filter media that do not meet the following specifications should be rejected.

- Organic matter content less than 5% in areas where nutrients are the contaminants of concern. If metals were the primary contaminant then greater organic matter content would be appropriate.
- pH - 5.5-7.5
- Electrical conductivity < 1.2 dS/m

9 Transition and drainage layers

The transition layer material shall be a clean, well-graded coarse sand material containing little or no fines.

The drainage layer is to be clean, fine gravel, such as a 2-5 mm washed screenings.

If the soils under the rain garden have high permeability, the underdrain can be eliminated and the practice will function as an infiltration practice with the filter media providing pre-treatment of run-off prior to infiltration.

Rain garden providing treatment prior to infiltration



10 Plant material

Consider the following when making planting recommendations:

- Native plant species should be specified over exotic or foreign species.
- Appropriate vegetation should be selected on its ability to thrive in wet and dry conditions.

The following two tables (Tables 9.7 and 9.8) provide some recommendations for rain garden plant species.

Table 9.7 Recommendations for trees and shrubs.

Trees and shrubs	Descriptions
<i>Brachyglottis repanda</i> rangiora	Coastal shrub or small tree growing to 4 m+. Large attractive pale green leaves with white fuzz on underside.
<i>Coprosma acerosa</i> sand coprosma	Grows naturally in sand dunes. Yellow, interlaced stems and fine golden foliage. Forms a tangled shrubby ground cover. Tolerates drought and full exposure. Prefers full sun.
<i>Coprosma robusta</i> / <i>C. lucida</i> karamu, shining karamu	Shrubs or small trees growing to 3 m+, with glossy green leaves. Masses of orange-red fruit in autumn are attractive to birds. Hardy plants.

Trees and shrubs	Descriptions
<i>Cordyline australis</i> ti kouka, cabbage tree	Palm-like in appearance with large heads of linear leaves and panicles of scented flowers. Sun to semi-shade. Prefers damp to moist soil. Grows eventually to 12 m+ height.
<i>Cordyline banksii</i> ti ngahere, forest cabbage tree	Branching from the base and forming a clump. Long strap-shaped leaves with red-orange coloured veins. Prefers good drainage and semi-shade.
<i>Corokia buddleioides</i> korokio	Bushy shrub to 3 m, with pale green leaves with silvery underside. Many small bright yellow starry flowers are produced in spring. Prefers an open situation but will tolerate very light shade.
<i>Entelea arborescens</i> whau	Fast growing shrub or small tree (to 5 m height) with large bright green heart-shaped leaves. Spiny seed capsules follow clusters of white flowers in spring. Handsome foliage plant.
<i>Geniostoma rupestre</i> hangehange	Common forest shrub with pale green glossy foliage, growing to 2-3 m. Tiny flowers give off strong scent in spring. Looks best in sunny position where it retains a bushy habit, and prefers well drained soil.
<i>Hebe stricta</i> koromiko	Shrub or small tree growing to 2-5 m in height. Natural forms have white to bluish flowers. Many cultivars and hybrids available with other colours, but unsuitable for use near existing natural areas. Full sun.
<i>Leptospermum scoparium</i> manuka	Shrub or small tree growing to 4 m+ in height. Natural forms have white to pinkish flowers. Many cultivars and hybrids available with other colours, but unsuitable for use near existing natural areas. Hardy and tolerant of difficult conditions.
<i>Metrosideros robusta</i> rata	Eventually forms a large tree. Flowers bright red in summer. Will tolerate dryness and exposure. Full sun.
<i>Pittosporum cornifolium</i> tawhirikaro	A slender branched shrub grown for its attractive fruiting capsules which are brilliant orange when split open. Sun or semi-shade.
<i>Pittosporum kirkii</i>	A small tree with dark green leaves and large yellow flowers in the summer. Prefers shade.
<i>Pseudopanax crassifolius</i> horoeka	Very narrow rigid and leathery leaves in its juvenile form. Stunning in amongst bold leaved plants. Sun or semi-shade.
<i>Pseudopanax lessonii</i> houpara	Small tree with attractive foliage. Tolerates full exposure and drought. Sun or semi-shade.

Table 9.8 Grasses, ground covers and other plants.

Grasses, ground covers, and other plants	Description
<i>Arthropodium cirratum</i> Rengarenga, renga lily	A lily with fleshy pale green/greyish leaves and white flowers. Ground cover in semi shady situation.
<i>Asplenium bulbiferum</i> mouku, hen and chicken fern	A robust fern with small plantlets produced on the fronds. Tolerates dryness and prefers shade.
<i>Asplenium oblongifolium</i> huruwhenua, shining spleenwort	Fern with large shiny fronds. Tolerates dryness. Prefers shade.
<i>Astelia banksii</i> kowharawhara, coastal astelia	Clump forming plant up to a metre high with flax-like leaves. Requires semi-shade. Tolerates full exposure. Frost tender.
<i>Astelia solandri</i> kowharawhara, perching astelia	An epiphytic plant in natural situations. Long drooping bright green leaves. Tolerates dryness. Prefers shade.
<i>Carex flagellifera</i> manaia, Glen Murray tussock	Sedge up to 70 cm high with reddish-brown spreading foliage. Prefers damp soil and full sun. Tolerates exposure.
<i>Carex testacea</i> sedge	Coastal sedge up to 40 cm high with shiny orange foliage. Prefers full sun and exposure. Tolerates dry soil conditions.
<i>Cortaderia fulvida</i> toetoe	Branching from the base and forming a clump to 4 m high. Long strap-shaped leaves with red-orange coloured veins. Prefers good drainage and semi-shade.
<i>Dianella nigra</i> turutu	Lily with reddish leaves, and striking violet-blue fruit. Ground cover; prefers open well-drained situation.
<i>Disphyma australe</i> glasswort	Fleshy leaved ground cover with mauve flowers in the spring. Tolerates drought and full exposure. Frost tender.
<i>Doodia media</i> pukupuku, rasp fern	Hardy fern growing to 25 cm. Young fronds coloured bright red when in full sun. Sensitive to frost.
<i>Libertia grandiflora</i> & <i>L. ixioides</i> mikoikoi, native iris	Clump forming native irises with narrow, upright leaves. Small white flowers in spring. Sun or shade.
<i>Phormium cookianum</i> wharariki, mountain flax	Clump-forming flax with yellow/green drooping leaves, to 2 m. Full exposure and sun.
<i>Phormium tenax</i> harakeke, flax	Clump-forming flax with large stiff leaves, to 3 m. Full exposure and sun.

Regarding planting, the following recommendations are made:

- 1 Species layout should generally be random and natural;
- 2 A canopy should be stabilised with an understory of shrubs and herbaceous plants;
- 3 Woody vegetation should not be specified in the vicinity of inflow locations;
- 4 Stressors (wind, sun, exposure) should be considered when developing the planting plan;

- 5 Noxious weeds should not be specified;
- 6 Aesthetics and visual characteristics should be given consideration;
- 7 Traffic and safety issues must be considered; and
- 8 Existing and proposed utilities must be identified and considered.

9.5.10 Case study

Project description

An industrial parking lot is proposed in Kawerau with a rain garden proposed due to aesthetic reasons and for dissolved metals. The total extent of the catchment being served is 2,000 m² of which 80% is impervious with the remainder being grassed.

Hydrology

- 1 The water quality storm is 24.9 mm or rainfall.
- 2 Calculate the water quality volume to be treated.

$$A_{wq} = 0.9(\text{imp. \%}/100) \times \text{total site area} + 0.15(\text{pervious \%}/100) \times \text{total site area}$$

Where total site area = m²

$$A_{wq} = 0.9(80\%/100) \times 2,000 + 0.15(20\%/100) \times 2,000 = 1,500 \text{ m}^2$$

The water quality volume $V_{wq} = 0.0249 A_{wq}$

$$V_{wq} = .025(1500) = 37.35 \text{ m}^3$$

Rain garden design

- 1 Live volume of storage needed $V_t = .40 (37.35 \text{ m}^3) = 14.9 \text{ m}^3$
- 2 Calculate the required surface area of the rain garden.

$$A_{rg} = (WQV)(d_{rg})/k(h+d_{rg}) t_{rg}$$

Where:

- A_{rg} = Surface area of rain garden (m²)
- WQV = Water Quality treatment Volume (m³)
- d_{rg} = Planting soil depth (m)
- k = Coefficient of permeability (m/day)
- h = Average height of water (m) = ½ maximum depth
- t_{rg} = Time to pass WQV through soil bed

The following values should be used:

- d_{rg} = 0.85 m
- k = 0.75 m/d
- h = 0.15 m (maximum water depth 300 mm)
- t_{rg} = 1.5 days
- $A_{rg} = 37.35(.85)/0.75(0.15+0.85)(1.5)$
- $A_{rg} = 28.2 \text{ m}^2$

Check to see that there is adequate live storage (14.9 m^3). Live storage available = surface area times maximum depth or $(28.2)(.3) = 8.46 \text{ m}^3$ so the rain garden surface area has to be increased by 21.5 m^2 to provide the necessary live storage which gives a total surface area requirement of 49.7 m^2 .

In most cases, the live storage requirement will govern the size of the rain garden. If live storage can be provided upstream of the rain garden the overall size may not need to increase but the live storage must be available somewhere upstream.

In terms of a treatment train approach, Kawerau does not have a nutrient issue so suspended solids is the contaminant of concern. The rain garden does not have to have an anaerobic zone and sediment retention capability is approximately 90%.

9.5.11 Infiltration

Description: Infiltration practices are designed and constructed to capture and treat stormwater run-off through:

- Filtration
- Infiltration, and
- Adsorption, and
- Biological uptake



Infiltration practices direct urban stormwater away from surface run-off paths and into the underlying soil. In contrast to surface detention methods, which are treatment or delay mechanisms that ultimately discharge all run-off to streams, infiltration diverts run-off into groundwater. Of all the traditional stormwater management practices, infiltration is one of the few practices (together with revegetation and rain tanks) that reduce the overall volume of stormwater being discharged.

Infiltration practices comprise a suite of different practices, including:

- Infiltration basins
- Trenches
- Soakage pits
- Modular block porous pavement
- To a certain extent, rain gardens, swales and filter strips that are considered separately.

Stormwater Management Function

	Water quality	
<input checked="" type="checkbox"/>	<input checked="" type="checkbox"/>	Metals
	<input checked="" type="checkbox"/>	Sediment
	<input checked="" type="checkbox"/>	TPH
<input type="checkbox"/>		Flood protection
<input checked="" type="checkbox"/>		Stream channel erosion protection

Figure 9.13 - Schematic of in infiltration basin

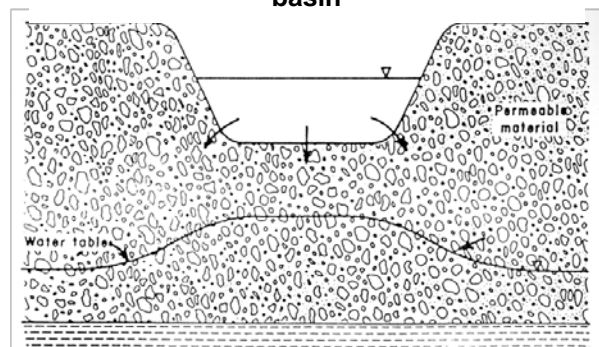

Schematics for these practices are shown in figures 9.13, 9.14, 9.15 and 9.16.

Figure 9.14 - Schematic of an infiltration trench

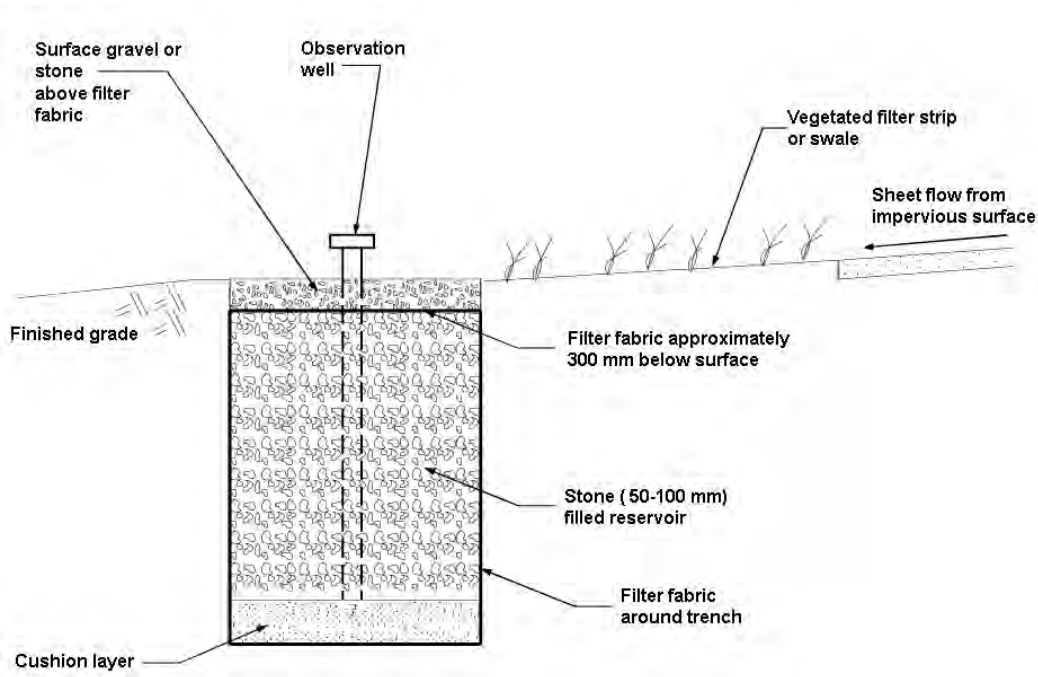

Infiltration practices are used for three primary purposes:

- Reducing the total volume of stormwater run-off;
- Reducing the contaminant loadings downstream; and
- Low streamflow augmentation.

The use of infiltration practices for water quality treatment must be considered with caution. Infiltration practices are much more sensitive to clogging than are ponds or filters. As much as possible, sediment should be prevented from entering these practices.

Figure 9.15 - Schematic of a soakage pit

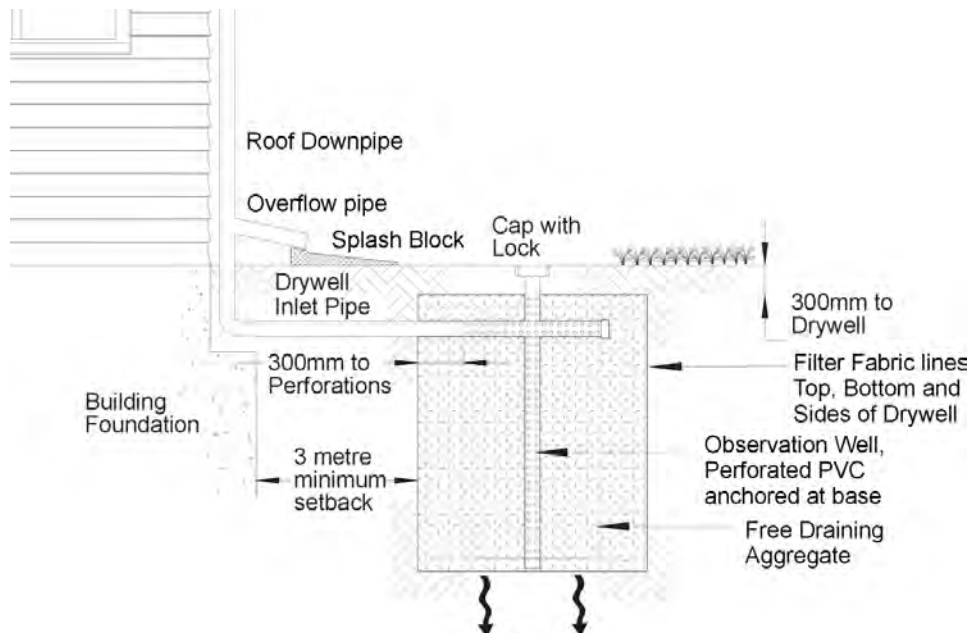
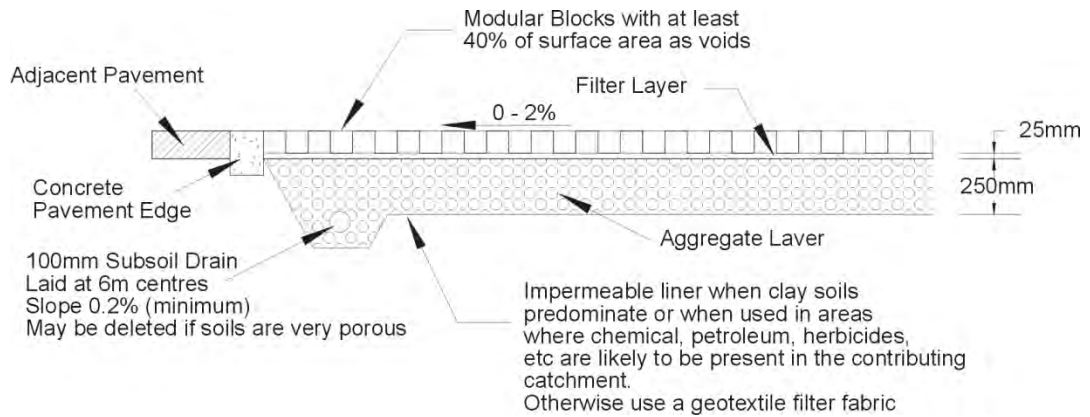

Figure 9.16 - Schematic of a permeable pavement



An infiltration basin is essentially a pond that has no surface outlet. The only way for the water to leave the ponded area is for infiltration to occur. Figure 9.13 shows a schematic of an infiltration basin.

Infiltration trenches receive run-off in a shallow excavated trench that has been backfilled with stone to form a below-grade reservoir. Water then enters the underlying subsoil according to its infiltration rate.

Soakage pits function in a similar fashion with the excavated subgrade being filled with stone and relying upon the void spaces to provide for stormwater storage until the run-off infiltrates into the soil.

Modular block porous pavement permits precipitation to drain through paving blocks with a pervious opening. Paving blocks are appropriate only for areas with very light or no traffic or for parking pads. They are laid on a gravel subgrade and filled with sand or sandy loam turf but can also be used with grass in the voids which may require irrigation and lawn care during the summer months.

Applicability

Soil permeability is the most critical consideration for the suitability of infiltration practices. Practices are generally built in native soil; but when this is inappropriate, a soil system can be constructed with media such as sand, peat, or a combination. Table 9.9 provides information on the suitability of various soils for infiltration. The red line indicates that 7 mm is the lowest infiltration rate that is considered acceptable for use of infiltration practices. Infiltration practices normally convey most run-off directly into the soil to eventually enter the groundwater. Constructed soil systems usually require underdrains.

Table 9.9 Infiltration rate for various soil textural classes.

Texture class	Approximate infiltration rate in mm/hour
Sand	210
Loamy sand	61
Sandy loam	26
Silt loam	13
Sandy clay loam	7
Clay loam	4.5
Silty clay loam	2.5
Sandy clay	1.5
Silty clay	1.3
Clay	1.0

The next most crucial considerations for the suitability of infiltration practices are:

- Avoiding clogging.
- Avoiding potential to contaminate groundwater.

Infiltration practices should be constructed in medium textured soils. They are generally unsuitable for clay because of restricted percolation and for gravel and coarse sands because of the risk of groundwater contamination (unless effective pre-treatment is provided).

Any impermeable soil layer close to the surface may need to be penetrated. If the layer is too thick, under drains may be required. As a minimum measure to prevent clogging, infiltration basins and trenches should require pre-treatment devices to settle larger solids and prevent sediment laden run-off from entering them. Infiltration soakage pits accept only roof run-off so pre-treatment is not expected, Pre-treatment is not possible for modular paving either other than keeping extraneous run-off from traveling onto the paving area.

The following guidance is applicable to design and implementation of all infiltration practices.

Site characteristics

Site characteristics relate to whether the infiltration practice is intended for quantity control alone or for both quality and quantity control. While quantity control is best achieved with a rapid percolation rate, this rate could be too fast to provide sufficient contact with the soil for contaminant capture, if the groundwater table is relatively close to the surface.

Consequently, BOPRC:

- Specifies a maximum and a minimum percolation rate to protect groundwater and attain contaminant capture objectives. Infiltration rates greater than 1 m/hr may indicate a direct link to a very permeable aquifer while slower than 7 mm/hr is too slow.
- Requires run-off pre-treatment to meet water quality objectives before the pre-treated run-off is infiltrated for quantity control or stream baseflow augmentation.

The following criteria aim to reduce the substantial risks of failure and groundwater contamination, and to achieve the desired urban stormwater management benefits:

- The invert of the infiltration practice should be at least one metre from the seasonal high water table, bedrock, or relatively impermeable soil layer.
- The percolation rate should be at least 7 mm/hr.
- The soil should not have more than 30% clay or more than 40% clay and silt combined.
- If the infiltration practice is to function primarily for water quality treatment, infiltration rates must not be greater than that given for sand.
- Infiltration practices must not be constructed in fill material.
- Infiltration practices must not be constructed on slopes exceeding 15%.
- Catchments draining to infiltration practices must not exceed four hectares, but preferably not more than two hectares.
- Infiltration basins are not normally encouraged for use unless approved on a case-by-case basis because their long-term historical performance has not been good, mainly as a result of surface clogging.

Pre-treatment

The use of vegetative filters as a pre-treatment practice to improve long-term performance of infiltration practices cannot be stressed enough.

Of primary importance to the long-term function of infiltration practices is the need to ensure all contributing catchment areas are stabilised. Sediment loadings into the practice must be kept to a minimum. All inspections of these practices must include inspection for site stabilisation. All areas draining to the infiltration practice must be stabilised or premature clogging of the facility will result. Infiltration practices should have annual inspections done for assessing sediment accumulation. The frequency of actual maintenance activities depends on loadings from contributing catchment areas.

Infiltration pond in Papamoa having some pre-treatment with filter strips



Objectives

Because infiltration practices are one of only a few practices that reduce the total volume of run-off, objectives relate to:

- Peak flow reduction.
- Contaminant removal.
- Low stream flow augmentation.

Due to the sensitivity of infiltration practices to clogging, they are best utilised to augment low stream baseflow, with pre-treatment to reduce contaminant loads so that the cleaner water infiltrates to maintain groundwater levels and maintain low stream flow.

If long-term responsible maintenance can be assured, infiltration is appropriate as a water quality treatment practice.

Design approach

There are a number of items that should be considered when infiltration practices are used.

Site characteristics

A site characterisation must be done to determine the following:

- Topography within 150 m of the proposed infiltration practice.
- Site use.
- Location of any water supply wells within 150 m of the proposed infiltration practice.
- Local site geology to gain understanding of soil and rock units likely to be encountered, the groundwater regime and geologic history of the site.
- For infiltration basins, one test pit or test hole should be placed every 200 m² of basin invert.
- For infiltration trenches, at least one test pit per 15 m of trench length and 2.5 times deeper than the invert depth of the trench.
- For soakage pits, at least one test pit for each pit. The test pit should be 1.5 times deeper than the invert depth of the soakage pit.
- For modular permeable pavement, there must be one test pit per 500 m² of infiltrating surface and the test pit should be 2.5 times deeper than the invert depth of the filter bed.
- The depth, number of test holes or test pits and sampling should be increased, if, in the judgment of the geotechnical engineer, the conditions are highly variable and increasing the depth or the number of explorations is necessary to accurately estimate the performance of the infiltration practice. In addition, the number of explorations may be decreased if, in the opinion of the geotechnical engineer, the conditions are relatively uniform and the borings/test pits omitted will not influence the design.

- Detailed logs for each test pit or test hole must be prepared along with a map showing the location of the test pits or holes. Logs must include at a minimum, depth of pit or hole, soil description, depth to water, depth to bedrock or impermeable layer and presence of stratification.
- Install ground water monitoring wells (unless the highest ground water level is far below the infiltration practice) to monitor the seasonal ground water levels at the site.

Procedure for conducting an infiltration test

The required approach consists of a relatively large-scale infiltration test to better approximate infiltration rates for design of infiltration practices. This approach reduces some of the scale errors associated with relatively small-scale double ring infiltrometer or “stove pipe” infiltration tests.

- 1 Excavate the test pit at least 1.5 m below the bottom of the proposed infiltration practice. Lay back the slopes sufficiently to avoid caving and erosion during the test.
- 2 The surface area of the bottom of the test pit shall be at least 1 m².
- 3 Install a vertical minimum 1.5 m long measuring rod marked in 10 mm increments in the centre of the pit bottom.
- 4 Use a rigid 150 mm pipe with a splash plate on the bottom to convey water to the bottom of the pit and reduce side-wall erosion or excessive disturbance of the ponded bottom.
- 5 Add water to the pit at a rate that will maintain a water level of between 1-1.25 m above the bottom of the pit. A rotameter can be used to measure the flow rate into the pit.
- 6 Every 15-30 minutes, record the cumulative volume and instantaneous flow rate in litres per minute necessary to maintain the water level at the same point on the measuring rod.
- 7 Add water to the pit until one hour after the flow rate into the pit has stabilised (constant flow rate) while maintaining the same ponded level.
- 8 After one hour after the flow rate has stabilised, turn off the water and record the rate of infiltration in mm/hr from the measuring rod data, until the pit is empty.
- 9 Based on partial clogging, reduce the derived infiltration rate by a factor of 0.5 and reduce this reduced rate in the design calculations.

Site data analysis

- Determine representative site infiltration rate from soil test results and the stratification identified during the site investigation.
- Determine the textural class from the U.S. Department of Agriculture (USDA) textural triangle in Figure 9.17. Sand is defined to have a diameter between 2 mm and 0.05 mm while clay has a diameter of less than 0.002 mm. Once the textural class has been determined, the infiltration rates can be found.
- Determine infiltration rates by taking direct in-situ measurements of soil infiltration rates.
- Long-term infiltration rates greater than 1 m/hr (as per steps 8 and 9 above) are considered too rapid to allow significant water quality treatment to occur and pre-treatment will have to be provided.

Figure 9.17 - Soil textural triangle (Davis, Bennett, 1927)

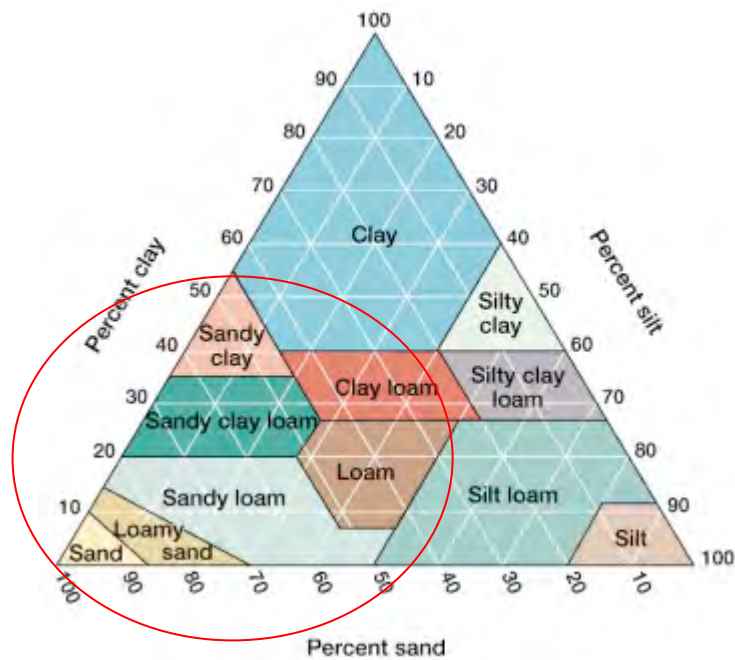

Detailed design procedure

This approach relies on Darcy's Law, which expresses flow through a porous media. There are two equations that are used: one for surface area of the practice (A_s) and one for its volume (V). A third equation provides a check that the maximum depth is not exceeded in the design to ensure that the practice drains in the two day drain period.

In terms of the design approach:

- 1 Determine the water quality rainfall from the 90% storm.
- 2 Calculate the water quality volume.
- 3 Size the practice surface area to allow complete infiltration within 48 hours, including rainfall falling directly on it. Use the following equation to determine surface area:

$$A_s = \frac{WQV}{((f_d)(i)(t)-p)}$$

Where:

- A_s = Surface area of the trench (m^2)
- WQV = Water quality volume (m^3)
- f_d = Infiltration rate (m/hr) - rate reduced by $\frac{1}{2}$ from measured
- i = Hydraulic gradient (m/m) - assumed to be 1
- t = Time to drain from full condition (hours) - maximum time 48 hours
- p = Rainfall depth for water quality storm (m)

There is a simple test to see how deep an infiltration practice can be to achieve the discharge of the water quality storm. Any deeper than the amount calculated will not achieve the two-day draw down period. The equation is the following:

$$d_{\max} = f_d(t/V_r)$$

Where:

d_{\max} = Maximum depth of trench

f_d = Infiltration rate (m/hr)

t = Time to drain from full condition (hours)

V_r = Void ratio of reservoir stone (normally 0.35 or 0.5 if scoria is used), 1 for infiltration basins.

Once d_{\max} has been defined, the actual needed depth can be calculated. If the actual depth exceeds the maximum depth the surface area must be increased to account.

- 4 Find the practice volume to provide storage for 37% of the volume required to infiltrate. This allows for storage of excess run-off during those periods when the run-off exceeds the infiltration rate.

$$V = 0.37(WQV + pA_s/V_r)$$

Where:

V = practice volume with any aggregate added

NOTE: Permeable paving does not usually have a contributing drainage area draining to it. As such the volume of storage equals the following:

$V = pA_s/V_r$ where p is the design rainfall event (at least the water quality storm but generally to provide storage for up to the ten-year rainfall).

- 5 Calculate the practice depth and compare with the maximum depth.

$$V/A_s = \text{depth of trench (d)}$$

If $d < d_{\max}$ the design is adequate. If $d > d_{\max}$ then the surface area must be increased and depth decreased.

Infiltration practices direct urban stormwater away from surface run-off paths and into the underlying soil. In contrast to surface detention methods, which are treatment or delay mechanisms that ultimately discharge all stormwater run-off to streams, infiltration practices divert run-off into groundwater.

9.5.12 Case study

Project description

A small commercial development is proposed for Ōpōtiki with the development being 80% impervious and the total development size is 3,000 m².

Hydrology

- 1 Calculate the water quality volume (WQ rainfall = 25.4 mm ~ 25 mm)
 $A_{wq} = 0.9(\text{imp. \%}/100) \times \text{total site area} + 0.15 (\text{pervious \%}/100) \times \text{total site area}$
Where total site area = m^2
 $A_{wq} = 0.9(80\%/100) \times 3,000 + 0.15 (20\%/100) \times 3,000 = 2,250 m^2$
The water quality volume $V_{wq} = 0.025A_{wq}$
 $V_{wq} = .025(2,250) = 56.2m^3$

Infiltration trench design

- 1 Calculate the practice surface area
 $A_s = WQV/((f_d)(i)(t)-p)$
Where:
 A_s = Surface area of the trench (m^2)
 WQV = Water Quality Volume (m^3) = $40.5 m^3$
 f_d = Infiltration rate (m/hr) - rate reduced by $\frac{1}{2}$ from measured = 14 mm/hr reduced by $\frac{1}{2}$ as a factor of safety, so $f_d = 7 \text{ mm/hr} = 0.007 \text{ m/hr}$
 i = Hydraulic gradient (m/m) - assumed to be 1
 t = Time to drain from full condition (hours) - maximum time 48 hours
 p = Rainfall depth for water quality storm (m) = .015 m
 $A_s = 56.2/((.007)(1)(48) - .025) = 181 m^2$

Calculate the maximum trench depth

$$d_{\max} = f_d(t/V_r)$$

Where:

- d_{\max} = Maximum depth of trench
- f_d = Infiltration rate (m/hr) = 0.007 m/hr
- t = Time to drain from full condition (hours) = 48 hours
- V_r = Void ratio of reservoir stone = 0.35
- $d_{\max} = .007(48/.35) = 0.96 \text{ m}$

- 2 Find the trench volume.
 $V = 0.37(WQV + pA_s)/V_r = 0.37(56.2 + 0.025 (181)/.35) = 64.2 m^3$
- 3 Calculate the trench depth and compare with the maximum depth
 $V/A_s = \text{depth of trench (d)} = 64.2/181 = 0.355 \text{ m}$
 $d < d_{\max}$ so the design is adequate

In terms of a treatment train approach, Ōpōtiki does not have a nutrient issue so suspended solids is the contaminant of concern. The infiltration trench has a sediment retention capability is approximately 80%.

9.5.13 Stormwater management ponds

Description: Stormwater management ponds can provide peak flow control and water quality treatment. Processes for contaminant reduction are primarily related to:

- Sedimentation

Stormwater management ponds have been used in local programmes for years, initially for water quantity control, but more recently also for water quality control. They have been, and are expected to remain, important components in the stormwater effort to minimise adverse impacts associated with urban land use.

This section reviews ponds that are either normally dry or normally wet. Both forms of pond can and may possibly have an extended detention component to them. This Section does not include discussion of wetland ponds. Wetland ponds, while having much in common with deeper ponds are being considered separately within Section 9.5.7, a more detailed discussion of the additional functions that they provide.

Ponds are defined as:

Dry pond

A permanent pond that temporarily stores stormwater run-off to control the peak rate of discharges and provide water quality treatment, primarily through the incorporation of extended detention. These ponds are normally dry between storm events.

Wet pond

A permanent pond that has a standing pool of water. These ponds can, through their normal storage of water, or in conjunction with extended detention, provide water quality treatment. They can, also in conjunction with extended detention, provide protection of downstream channels from frequent storms.

Stormwater ponds are used for three primary purposes:

- Reducing downstream flood potential;
- Providing water quality treatment; and
- Minimising, to the extent possible, downstream channel erosion.



Stormwater Management Function

	Water quality
	~ Metals
<input checked="" type="checkbox"/>	✓ Sediment
	~ TPH
	~ possibly through specific design
<input checked="" type="checkbox"/>	Flood protection
<input checked="" type="checkbox"/>	Stream channel erosion protection

It may not be necessary in every situation to address all three purposes, but there will be sites, as discussed later in this Section, where all three functions will be included in the design.

Water quantity/quality performance

Ponds detain run-off, typically from a design storm, and then discharge it, usually at the pre-development peak discharge rate.

Traditionally ponds, especially dry ones, have been used primarily for flood protection. They normally detain run-off and then discharge it at a specified rate, reducing the potential for downstream flooding by delaying the arrival of run-off from upper parts of a catchment. More recently, wet and dry pond designs have been modified to extend the detention time of run-off thereby increasing particulate contaminant settling and minimising downstream channel erosion. Wet ponds are normally designed to have a permanent pool for storage of a specified water quality volume, in the BOPRC region this is 90% frequency storm. Wet ponds also have an outlet design that increases residence time and flow path.

Contaminant removal mechanism

The primary contaminant removal mechanism of all pond systems is settling or sedimentation. However, the effectiveness may vary to some degree depending on the type of detention system (dry or wet).

Flood detention ponds have limited effectiveness at providing sedimentation, as detention times may be several hours only, so only the coarser particles can be removed from the water column.

Extended detention ponds that are normally dry also rely on sedimentation during shore periods of live storage only although they typically hold flows for longer than flood detention ponds.

The best approach for particulate removal is the combination of extended detention in conjunction with a normal wet pool. The pool allows for displacement of water previously stored and the extended detention allows for better sedimentation of excess storm flows.

Expected performance

Ponds can be effective at reducing peak discharge rates. Depending on their design and their location within a catchment, they may also be effective in reducing downstream channel erosion, downstream flood levels and flooding.

Effectiveness at contaminant removal depends on the type of pond system. In general, they can be ranked, from least to most effective, in their ability to remove stormwater contaminants: dry detention, extended dry detention, and then wet detention.

Constraints on the use of ponds

Dry ponds

- Need fairly porous soils or subsurface drainage to assure that the bottom stays dry between storms.
- Not suitable in areas with high water tables or shallow depth to bedrock.

- Not suitable on fill sites or steep slopes unless geo-technically checked.
- May not be suitable if receiving water is temperature sensitive as detention ponds do not detain water long enough to reduce temperatures from impervious surfaces.

Wet ponds

- Not suitable on fill sites or near steep slopes unless geo-technically checked.
- May need supplemental water supply or liner system to maintain permanent pool if not dug into the groundwater.
- Minimum contributing drainage area of six hectares is needed to maintain the permanent pool.
- Not feasible in very dense urban areas or areas with high land costs due to large surface area needs.
- May not be suitable if receiving water is temperature sensitive due to warming of pond surface area.
- Safety issues need to be addressed, depending on normal pool depth.

Dry flood detention ponds are not normally recommended for stormwater management systems. They have ongoing maintenance needs because standing water in areas where positive drainage is impeded may cause mosquito problems, and their overall performance for water quality treatment is less than provided by wet ponds. A study in the U.S. (DNR. 1986) indicated that over 70% of the dry ponds in a given jurisdiction were not functioning as designed. In addition, dry ponds tend to have less aesthetic appeal than wet ponds.

Pond component disclaimer

The technical safety criteria for pond design and construction that are beyond the scope of this document include:

- Minimum dam top width;
- Embankment side slopes;
- Seepage control;
- Foundation standards;
- Foundation cut-off;
- Outlet protection; and
- Access and set aside area for sediment drying.

Two issues that will be discussed in this part are minimum spillway capacity, as spillway design will affect the duration of detention and therefore stormwater quantity and quality control, and pond forebay areas and capacity. These will be discussed in the Design Procedure section. A typical wet pond is shown in Figure 9.18.

Figure 9.18 - Typical wet pond.

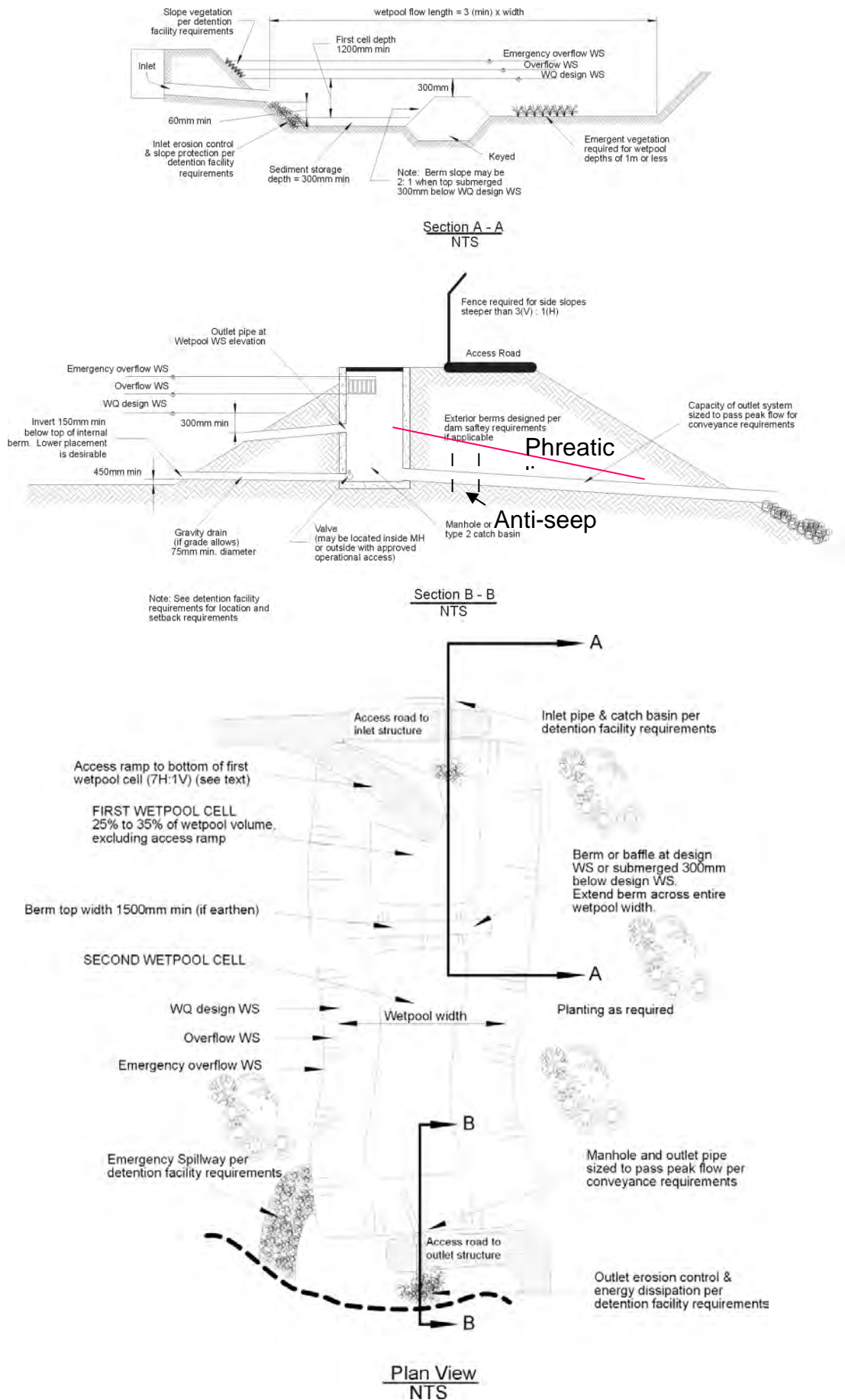

The issue of seepage control is important to the long-term stability of a dam. BOPRC advocates a filter collar approach rather than using anti-seep collars. A standard detail of a filter collar is shown in Figure 9.19.

Figure 9.19 - Design detail for a filter collar

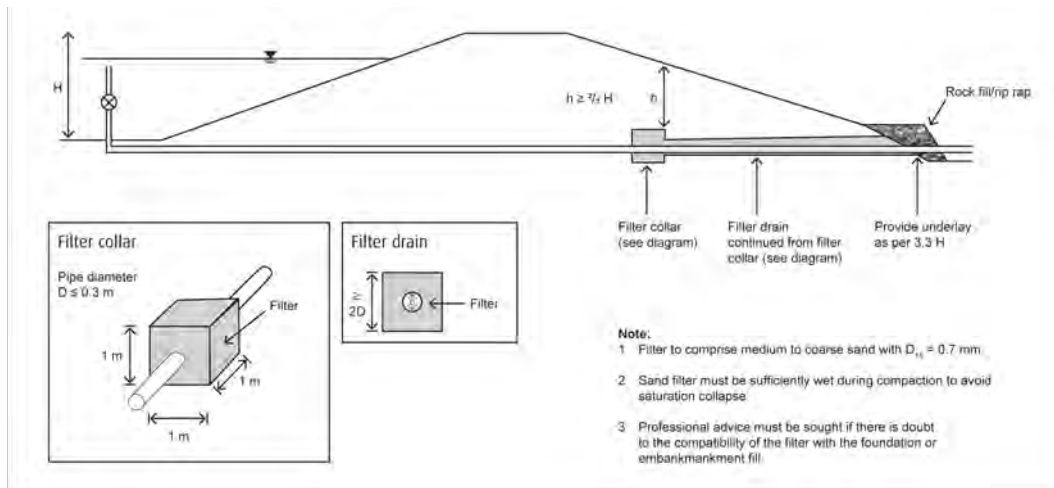

Design approach

Objectives

Water quantity objectives

Urbanisation has dramatic impacts on the amount of stormwater run-off that is generated from a catchment. Ponds, when properly sized, can be a primary quantity control practice.

BOPRC criteria for water quantity control depend on the receiving environment. If the receiving environment is a piped stormwater reticulation system with adequate capacity for the increased run-off or tidal (either estuarine or marine), then water quantity control is not an issue and a number of practices can be used to achieve water quality goals. If the receiving environment is a stream, then control of peak rates of run-off may be a requirement, and ponds become a primary option for controlling discharge rates.

BOPRC may require on a case-by-case basis that both the two and ten-year storms remain at their pre-development peak rates for those storms. The intent of peak discharge control of storms of two different frequencies is to achieve benefits for a range of discharges. Controlling the peak rates for the two and ten-year storms provides control of storms between those intervals and also will provide management for a percentage of peak flows from storms of greater magnitude (Maryland, 1982).

Where there are downstream flooding issues, peak discharges for the post development 100-year 1% AEP storm event may need to be managed to ensure that downstream flood levels are not increased. Depending on the catchment, the number of tributaries and the location of the project in a catchment, timing of flow discharges may be an issue. If so, a catchment wide study may be necessary to ensure that downstream flood risks are not increased. If there is no catchment-wide study, work done by Manukau City Council and overseas has indicated that limiting the peak discharge of the 100-year storm to not exceed 80% of the pre-development 100-year storm will reduce downstream flood increase concerns. The 80% peak discharge rate reduces potential for coincidence of elevated flow downstream by extended release of the flows. BOPRC may accept this approach as an alternative to a catchment wide study.

Water quality objectives

Water quality objectives aim for removal of TSS. Ponds are not as appropriate for dissolved contaminants so treatment of metals may require other practices to be used in conjunction with ponds. They are more appropriate where sedimentation can achieve stated goals.

Where possible, water quality ponds need a bypass for larger flows. Because all flows travel through the pond, water quality performance during larger events will be reduced as first flush contaminants are carried through it. Ideally, larger flows should bypass the pond in order to avoid a drop in water quality performance, albeit at the expense of its ability to provide peak flow reduction for larger storms.

In those situations, it may be best to use a treatment train approach to stormwater where other practices provide primary water quality treatment while the pond is primarily used for water quantity control. Although desirable, this approach may not always be possible due to site constraints.

There is a direct linkage between water quality treatment and flow control. If catchment considerations necessitate peak controls, it is recommended that 50% of the calculated water quality volume be placed as dead storage while 50% of the water quality volume can be live storage and released as part of the extended detention rainfall capture and release requirement (as discussed in the next section). This water quality credit can only be provided when storage and release of the run-off from either the 90% storm or 1.2 times the 90% storm rainfall is required. The permanent storage will reduce flow velocities entering the pond, while the extended detention will facilitate (in addition to the wet pool) settlement of particulates. If there is no requirement for either extended detention or peak control, the entire water quality volume can be stored within the permanent pool level.

Channel protection objectives

Urban development has the effect of increasing the frequency and magnitude of floods, particularly during frequent small storm events. As a consequence streams can suffer an increase in erosion, as channels enlarge to cope with the increased storm response. The objective of criteria related to channel protection is to maintain or improve the in-stream channel stability to protect ecological values of the stream and reduce sedimentation downstream.

A study (BECA, 2001) for the Auckland region recommends that the pond outlet should be designed to convey the volume generated by the first 30 mm of run-off over the total catchment area and release that volume over a 24 hour period from a two-year frequency storm event. However, because more extensive impervious surfaces upstream require more storage to achieve the discharge target, BOPRC may require on a case-by-case basis that the run-off from 1.2 times the water quality volume to be stored and released over a 24 hour period to minimise potential for stream channel erosion.

This provision is in addition to normal stormwater quality and flow attenuation requirements. However, by using extended detention for some of the stormwater quality treatment rather than a full wet pond, the treatment and erosion attenuation volumes may be partially combined, reducing total pond volume.

Ponds in series

BOPRC does not generally recommend the use of ponds in series instead of a single pond with an equivalent surface area. If the single pond were divided into two ponds in series then each of the two ponds would have approximately $\frac{1}{2}$ of the surface area of the single one. Each pond then has half the detention time, so the first pond takes out the coarser sediment. The flow is then remixed in the channel between ponds, and the second pond is too small to take out the finer fractions. Therefore ponds in series may be less efficient than single large ponds of equivalent volume.

However, sometimes site constraints make it necessary to use two or more treatment ponds in series rather than one larger single pond. To offset the reduction in sediment removal, where two or more ponds in series are necessary they should be sized at 1.2 times the volume specified in this document for a single pond. Where there are no specific site constraints, a single pond is preferred.

Preferences

Preferences for wetlands versus ponds

While this Guideline is a 'toolbox' of available stormwater management practices, constructed wetlands are preferred to open water ponds because they provide better filtration of contaminants, including dissolved ones due to densities of wetland plants, incorporation of contaminants in soils, adsorption, plant uptake, and biological microbial decomposition (more in depth discussion in Section 9.5.7). In addition, wetlands, being shallow water bodies do not have the safety issues associated with deeper water ponds. For these reasons, the BOPRC has a preference for shallow wetland ponds where ponds are used.

On-line versus off-line

BOPRC has preference for 'off-line' placement of ponds rather than 'on-line'. Off-line ponds are considered to be those ponds not physically located in perennial watercourses. They can be in gullies or upland areas. On-line ponds are located on streams having perennial flows and their impact to the stream itself can be significant. On-line ponds alter geomorphic and biological character of streams and these alterations may adversely impact on the streams natural character and function.

However, while off-line ponds are a preference, it is not a hard and fast rule. On-line ponds will be considered on a case-by-case basis to determine suitability.

There may be mitigation requirements placed on on-line ponds to compensate for the loss of stream habitat when an on-line pond is accepted for a specific location.

Dry ponds versus wet ponds

Dry ponds are not normally recommended. They need more maintenance and have a lower water quality performance than wet ponds. In terms of preference when ponds are the selected options, constructed wetlands are a first choice, followed by wet ponds, and finally dry ponds.

Maintenance responsibility

The issue of ensuring an entity is responsible for maintenance must be considered as an issue to determine whether ponds are applicable in a given situation. Ponds are expensive and require routine and non-routine maintenance to ensure proper long-term performance or failure of the pond system can occur. While a swale can fill in or a sand filter clog, pond failure can have significant effects, such as property damage and potential loss of life. Ponds must therefore be regarded as small dams, and evaluated in the context of best practice for dam operation. If maintenance responsibility cannot be defined during the design phase, ponds should not be selected for a given site.

Safety features

Depth

Deeper ponds can be attractive to children who like open water. Historically, ponds have been 1-3 m deep, sometimes over anyone's head. Stormwater ponds should not be deeper than 2 m, if at all possible. If water quality volume requirements and site limitations limit pond area, then use a wetland and extended detention live storage to achieve the water quality volume.

Benches

A reverse slope bench or slope break should be provided 300 mm above the normal standing water pool (where there is a normal pool) for safety purposes. All ponds should also have a shallow bench 300 mm deep that extends at least 3 m from the shoreline, before sloping down to the pond floor. This shallow bench will facilitate the growth of emergent wetland plants and also act as a safety feature.

Figure 9.20 - Schematic of safety benches and slopes

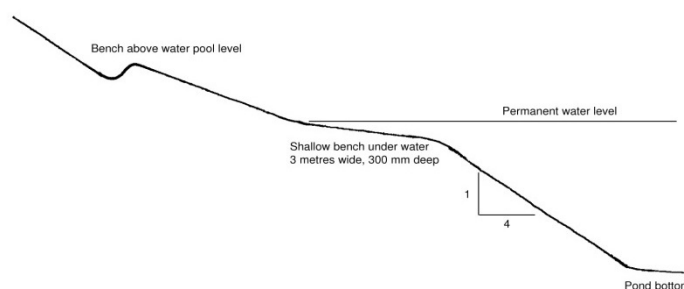

In addition to the benches, the steepness of the pond slope down to the invert of the pond should not exceed 4 horizontal to 1 vertical. Steeper slopes will make it very difficult for someone who is in the pond to get out of it. A schematic of pond safety features is shown in Figure 9.20.

The reverse slope above the waterline has at least three functions. It:

- 1 Reduces rill erosion that normally would be expected on longer slopes.
- 2 Intercept particulates traveling down the slope and conveys them to the pond inflow.
- 3 Provides an additional safety feature to reduce the potential for children running or riding uncontrolled down the slope and falling into the pond.

Fences

BOPRC does not require fencing of ponds, because it is considered that use of natural features such as reverse benching, dense bank planting, and wetlands buffers (which consists of a dense stand of vegetation) will provide a similar level of protection. The fencing requirement may be reconsidered on a case-by-case basis.

Aesthetics

Aesthetics must be considered as an essential pond design component. Ponds can be a site amenity if properly designed and landscaped or can be a scar on the landscape. The developer and designer should consider the pond as if they themselves were to be living in the development. Small items can have a big influence on the liveability of a given area to residents and the best time to consider the issue is during the design phase. There is a greater discussion of landscaping in Section 11.

Design procedure

Approach

Pond design tasks, in order, include the following:

- 1 Determine the need for water quantity control. In normal situations if it is required, that requirement will be to limit post-development peak discharges for the two and ten-year frequency storms to their pre-development peak discharge release rates.

If downstream flooding is documented, the post-development 100-year storm peak discharge rate may also need to be limited. In this case, a catchment analysis may be necessary or, as an option to the catchment analysis, limiting the 100-year peak discharge to 80% of the pre-development release rate.
- 2 Protect channel form in receiving environment. If the discharge enters a perennial natural stream channel, its channel will need to be protected from erosion. In such cases the run-off from either the 90% storm or 1.2 times the 90% storm shall be stored and released over a 24-hour period.
- 3 Determine the need for water quality control. Calculate the water quality volume (based on 90% rainfall) that needs to be treated when detention is required, and provide at least 50% of that volume as permanent pond storage. The other 50% stores and releases run-off from either the 90% storm or 1.2 times the 90% storm over a 24-hour period.

A hydrological analysis is needed for up to five rainfall events including the two-year, ten-year, possibly 100-year, 1.2 times the water quality rainfall, and the water quality rainfall. The two, ten, and 100-year events must be done for both pre and post-development while 1.2 times the water quality rainfall (erosion protection) and 90% rainfall (water quality treatment) events are based on the post-development condition.

Spillways and outlet capacity

There are two primary outlets from a pond: the service outlet and the emergency outlet. They will be discussed in the context of their sizing. Figure 9.21 illustrates the various outlet elements and components. The terms detailed in the figure are those used in the hydraulic flow discussion of this part.

Figure 9.21 - Schematic of pond outlet components

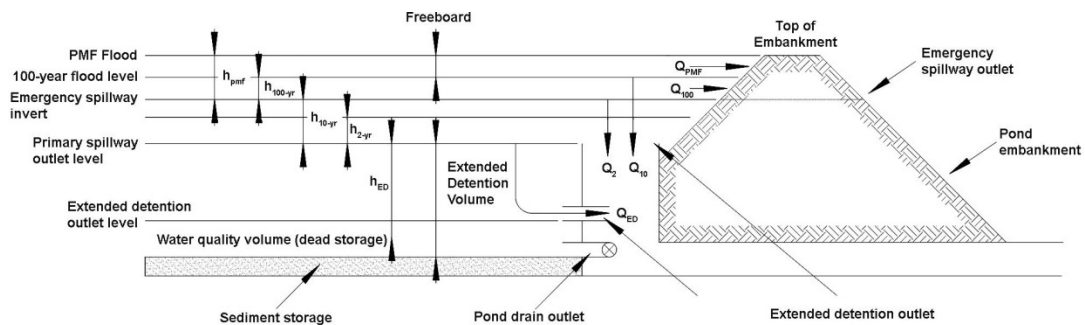

Service outlet

The service outlet should be designed to at least accommodate the flows from the primary drainage system entering the pond. The service outlet will normally convey the flow from the extended detention orifice, the two-year storm and the ten-year storm. In addition, the service outlet should also have a gate valve at the invert of the normal pool to allow for drainage of the pond during maintenance.

When an extended detention orifice is required, that orifice shall not be less than 50 mm in diameter (or 50 mm wide if a slot) unless a cover plate or screen device is used to prevent clogging of the orifice as shown in Figure 9.22. If calculations indicate an orifice (or slot) of smaller size, attention must be given to implementation of protective measures such as cover plate or other means, to prevent blockage of the orifice. It is important to consider blockage on all outlet devices but the extended detention outlet will be susceptible to blockage unless specifically designed for.

Figure 9.22 - Example of an orifice cover plate to prevent clogging

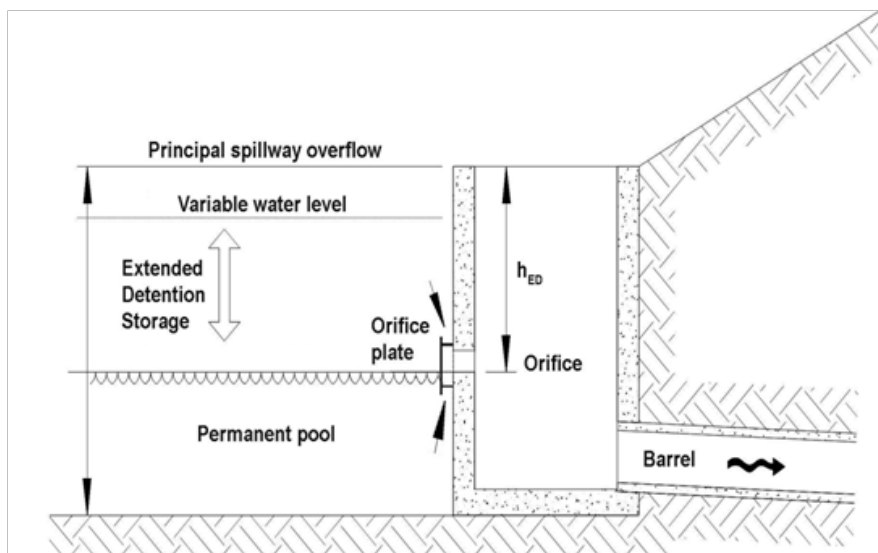

Two points are important when using a cover plate.

- 1 The cover plate should be less than the diameter of the orifice from the orifice wall. If the orifice is 40 mm in diameter, the orifice plate should be no more than approximately 35 mm from the wall.
- 2 A good rule of thumb is to have the opening area of the orifice plate at least five times the area of the orifice. This would include the area from all four sides (if a rectangular plate is used).

Emergency spillway

The emergency spillway will convey flows beyond the service spillway's capacity. It should be designed to convey at least the 100-year storm with a freeboard of at least 300 mm.

The emergency spillway should be located in natural ground and not placed on fill material unless it is armoured to prevent scour of the embankment. Operating velocities must be calculated for spillways in natural ground in order to determine the need for additional armouring. If the emergency spillway is placed on fill, the embankment should be constructed higher than the final design to allow for settlement.

In situations where embankment failure may lead to loss of life or extreme property damage, the emergency spillway must be able to:

- Pass an extreme flood, which may be the Probable Maximum Flood (PMF), with no freeboard (after post-construction settlement) and with the service outlet blocked. The PMF is defined as the largest probable flood event that could occur at the site, or the theoretical upper limit to flood magnitude. The extreme flood (Q_V) is defined as detailed in NIWA Science and Technology Series No. 19, "A Guide to Probable Maximum Precipitation in New Zealand", June 1995. For high-risk dams discussion with BOPRC is essential to determine the needed factor of safety.
- Pass the full Q_{IV} (the 1% AEP event flow) assuming the service spillway is blocked with at least 0.5 m of freeboard (after construction settlement).

Forebay

A forebay must be provided for all wet ponds. The sediment forebay is intended to capture only coarse sediments and is the location where most frequent sediment cleanout will be needed because coarser particles comprise the highest proportion of incoming sediments in terms of total volume. Thus, the more frequent cleanout of the forebay area. Figure 9.23 provides a schematic for a typical forebay.

The forebay should meet the following criteria:

- 1 The volume of the forebay should be at least 15 % of the water quality volume (or 30% of the adjusted volume when extended detention is required). It should be cleaned out when filled in to about 50% of its design volume. The 15% criteria is greater than the requirement of the Erosion and Sediment Control Guidelines, which is 10%, so conversion of a sediment retention pond to a stormwater management pond will require some reshaping in addition to sediment cleanout.

- 2 Flow velocities from the forebay during the one-in-ten-year storm must be less than 0.25 m/s, in order to avoid re-suspension of sediment. In some cases this may necessitate more than the minimum forebay volume. The recommended depth of the forebay is 1 m or more, to reduce velocities.

Figure 9.23 - Forebay schematic

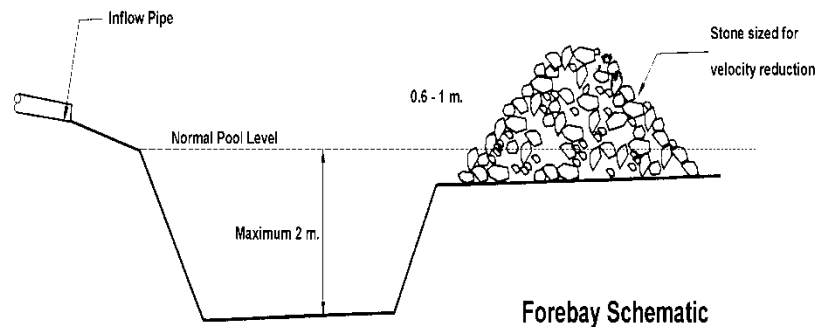

Hydraulic flow characteristics

- 1 Calculate the water quality volume to be treated using the 90% rainfall event.
- 2 Take a minimum of 50% of that volume for normal pool (dead) storage (when detention is required).
- 3 Use either the 90% or 1.2 times the 90% storm to determine the depth of run-off that is to be stored and released over a 24-hour period.
- 4 Conservatively assume that the entire extended detention volume is in the pond at one time even though this will not actually be the case since the outlet orifice will be sized to release this volume over a 24-hour duration.
 - Use an elevation - storage table to estimate the elevation required to store the full extended detention volume.
 - Calculate the average release rate (equal to the volume/duration) = Q_{ave} .
 - At the full extended detention design elevation, the maximum release rate is assumed to be $Q_{max} = 2(Q_{ave})$.
 - Calculate the required low flow orifice size: $Q_i = 0.62A(2gh_i)^{0.5}$ by trialling various orifice sizes.
 - h_i = elevation difference = the elevation at extended detention - the elevation at normal pool + $d/2$.

Other devices may be suitable for extended detention design, and all are based on a similar approach to the orifice opening approach. Those designs can include:

Multiple orifices at the same elevation (n orifices, A area each)

$$Q_i = 0.62A(2gh_i)^{0.5}$$

Vertical slot extending to water surface (width w)

$$Q_i = 1.8 w h_i^{3/2}$$

Vertically spaced orifices (situated h_1, h_a, h_b from surface of pond filled to the WQ volume. Each orifice area A)

$$Q = 0.62A(2gh_1)^{0.5} + 0.62A(2gh_a)^{0.5} + 0.62A(2gh_b)^{0.5}$$

$$\text{Pipe (area } A) \text{ } h = (1.5Q_i^2/2gA^2) + h_f$$

Where h_f is pipe friction loss

A number of different outlet designs for extended detention are detailed in Figure 9.24.

Figure 9.24 - Schematic of several extended detention outlet structures

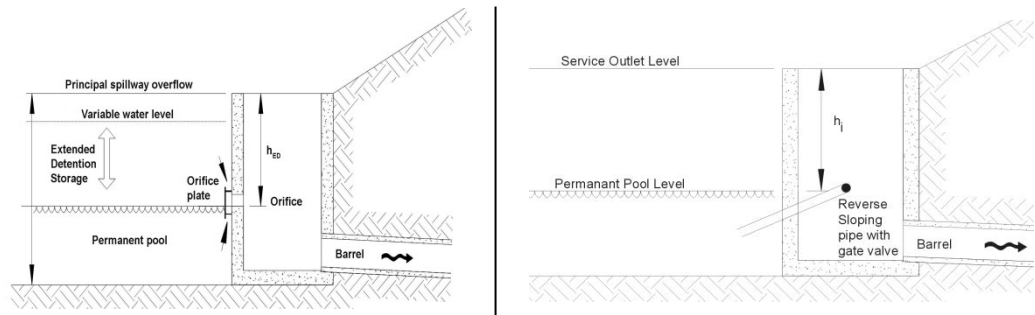

5 Two and ten-year stormwater management

Set the invert elevation of the two year release point at the extended detention water surface elevation (based on the elevation - storage table mentioned in step 4).

The service outlet may consist of a drop inlet structure, a broad crested weir, a cascade weir or a weir leading to an open channel. As peak control requirements call for both two and ten-year frequency storms to be controlled, the discharge is clearly defined in terms of the following equations.

Drop inlet

For moderate flows, the top of the drop shaft acts as a circular sharp weir. For a circular drop inlet, the energy head above the weir lip, (h_{ij}) can be used to calculate the flow according to:

$$Q_{ij} = 3.6pR h_{ij}^{3/2} \quad (\text{SI units})$$

Where R is the radius of the inlet.

For a box weir:

$$Q_{ij} = 7.0wh_{ij}^{3/2}$$

Where w is the length of the side of the square box, on the inside.

These equations apply only for $h_{ij}/R \leq 0.45$ (or, for a box inlet, $h_{ij}/w \leq 0.45$). For $h_{ij}/R > 0.45$, the weir becomes partly submerged, and for $h_{ij}/R > 1$ the inlet is fully submerged and the flow resistance is equal to the inlet resistance of a pipe, typically:

$$h_{ij} = k(v^2/2g)$$

Where v is the velocity at flow Q_{ij} and k is typically 0.5 to 1.0, depending on the details of the inlet.

For a circular inlet:

$$v = Q_{ij}/\rho R^2$$

Starting with the design flow and the chosen pipe radius, the head (h_{ij}) can be found by using the appropriate formula for the h_{ij}/R value. If this head is higher than desired, a large outlet can be used.

Aeration of the flow over the weir should be considered if the flows are so high that inadequate ventilation may cause damage to the drop structure. In general, adequate ventilation will be provided by appropriate sizing of the outlet pipes. It is recommended that the outlet pipe be sized so that when the emergency spillway is operating at maximum flow (Q_v), the outlet discharges at 75% full. Standard pipe friction and pipe outlet loss calculations can be performed to determine the required outlet size (USBR, 1977).

The entry to the outlet should be protected by a screen or grid cage to collect debris.

Broad crested weir

In this case, a weir narrower than the emergency weir is used. The weir could be situated away from the emergency weir, or if sufficient erosion protection is provided, in a lowered section of the emergency spillway.

The flow may pass down a single chute into a small plunge pool or appropriately lined area. Alternatively, a series of small cascades or a stepped spillway may be used. To size the weir, the change in pond elevation (h_{ij}) at the service design flow is found by solution of the following equation:

$$Q_{ij} = 0.57(2g)^{1/2}(2/3Lh^{3/2} + 8/15zh^{5/2})$$

As an approximation, the following formula may be used for a broad-crested weir:

$$Q_{ij} = 1.7 L h_{ij}^{3/2}$$

Weir with channel

This design will be useful for shallower ponds, where the channel can be easily constructed by making a cut in the embankment.

The outflow is controlled by the weir. Appropriate texts may be consulted for refined weir calculations, but the following may be used as an approximation for a sharp-crested weir:

$$Q_{ij} = 1.8Lh_{ij}^{3/2}$$

Where Q_{ij} is the service design flow, h_{ij} is the head over the weir when the emergency spillway starts operation and L is the length of the weir. The outlet channel should be sufficiently large that the water level is below the water level (h_{ij}) at the service design flow (to avoid backwater effects). The channel may require covering for safety reasons.

Emergency spillway design

The emergency spillway section is normally designed as a trapezoidal channel whose sizing is based on trial and error to the following equation:

$$Q = 0.57(2g)^{1/2}(2/3Lh^{3/2} + 8/15Zh^{5/2})$$

Where:

Q = Discharge through the spillway

L = Horizontal bottom width of the spillway

h = Depth of flow at design flow

Z = Horizontal/vertical side slope (recommended to be 3)

Designs to avoid short-circuiting

Dead zones and short-circuiting are undesirable because they reduce effective pond detention times. The flow path length must be at least twice the pond width, and preferably three times the width (but not much greater). The narrower the flow path, the greater the velocity and the less settling will occur. The designer should minimise dead zones and short-circuiting to improve the treatment performance of the pond.

Oil separation

Stormwater will, in most situations, contain oils and greases. Having an extended detention outlet similar to the reverse sloping pipe shown in Figure 9.24 will allow water to be discharged from below the surface and encourage volatilisation of the hydrocarbons on the surface.

Debris screens

Screens are used to trap rubbish and organic debris, which is unsightly, especially if trapped in vegetation. Screens should be used to protect extended detention outlets from clogging. Screens may be installed either at the inlet to the pond or at the outlet from the pond.

Ease of maintenance

Ease of maintenance must be considered as a site design component. Access to the stormwater management pond or wetland must be provided for in the design, and land area adjacent to the pond must be set aside for drying out of sediments removed from the pond when maintenance is performed.

The land set aside for pond maintenance should be sized as follows:

- 1 The set aside area shall accommodate at least 10% of the stormwater management pond volume at a maximum depth of 1 m; and
- 2 The slope of the set aside area shall not exceed 5%; and
- 3 The area and slope set aside may be modified if an alternative area or method of disposal is approved on a case-by-case basis.

Pond and site design

Pond shape

The design of pond shape should consider engineering constraints, design parameters to achieve treatment, and the existing topography. For a given catchment the design parameters include water volume, surface area, depth, water flow velocity and detention period. In addition, it is recommended that the length to width ratio be 3 horizontal to 1 vertical or greater to facilitate sedimentation. These parameters should be considered in light of the existing topography. Generally, a pond will look more natural and aesthetically pleasing if it is fitted into existing contours.

Pond contours

Pond contour profiles are critical to the design of a pond: they determine available storage, the range of plants that can be grown and the movement of water through the pond. The safety features of shallow slopes and reverse slopes will help provide areas suitable for a variety of plants.

Edge form

Edge form influences the appearance of a pond, increases the range of plant and wildlife habitats and has implications for pond maintenance. Edges can include sloping margins where water level fluctuations cause greater areas of wet soils. Generally, sloping margins require a more sophisticated management approach to ensure growth of plants. Areas of gradually varied wetness should be identified and specific planting strategies should be developed for these areas. Such gradually sloping areas can appear a more natural part of the landscape than steep banks, and they provide opportunities for a greater range of plants and habitat.

Islands

Islands, properly located, can be used to manipulate flow characteristics, to increase the distance that water travels and to help segregate first flush inflow from later flows within a storm event. They also increase the extent of planted margin and can provide a wildlife habitat that offers some protection from domestic animals or people, as well as offering additional aesthetic appeal.

Landscaping

Design of a stormwater pond system should ensure that the pond fits in with the surrounding landscape. General landscape design principles will apply. The area should develop a strong and definite theme or character. This might be generated from particular trees, or views from the site, topographical features, or the cultural character of the surrounding neighbourhood. The landscape design for the area will provide a setting for the pond so that the pond will appear a natural component of the overall setting.

9.5.14 Case study

Project description

A 100 lot residential subdivision in Tauranga is being constructed. It is 7.5 ha in size with no off-site drainage passing through it. It has gentle slopes and average imperviousness is expected to be 50%. Pre-development land use is pasture. The site drains into a stream channel so extended detention is a design component.

Hydrology

Water quality storm is 25 mm of rainfall

Two-year one-hour rainfall is 30 mm

Ten-year one-hour rainfall is 59 mm

Soil condition – high soakage gravels

Pre-development peak discharges and volumes are the following:

$$Q_{wq} = 0.00278 CIA$$

Q = Peak discharge

C = Run-off coefficient

I = Rainfall intensity (mm/hr)

A = Catchment area in hectares

Predevelopment C = 0.20

Two-year one-hour rainfall = 30 mm

Ten-year one-hour rainfall = 59 mm

$$Q_2 = 0.00278(0.20)(30)(7.5) = 0.13 \text{ m}^3/\text{s}$$

$$Q_{10} = 0.00278(0.20)(59)(7.5) = 0.25 \text{ m}^3/\text{s}$$

Post-development peak discharges and volumes are the following:

Water quality volume

$$A_{wq} = 0.9(50\%/100) \times 75,000 + 0.15(50\%/100) \times 75,000 =$$

$$\text{The water quality volume } V_{wq} = 0.025A_{wq} = 984 \text{ m}^3$$

Where 0.025 = 90% storm depth (m)

The run-off coefficient = 0.45

Post development rainfalls have to include global warming, so rainfalls for the two and ten-year storms have to be increased to get the volumes for storage.

$$\text{Two-year one-hour rainfall} = 30(2.1)(.067) + 30 = 34.2 \text{ mm}$$

$$\text{Ten-year one-hour rainfall} = 59(2.1)(.074) + 59 = 68.2$$

$$Q_2 = 0.00278(0.45)(34.2)(7.5) = 0.32 \text{ m}^3/\text{s}$$

$$V_{\text{estimated}} = 1.5(Q_{\text{post}})D = 1.5(.32)(3,600) = 1,728 \text{ m}^3$$

$$Q_{10} = 0.00278(0.45)(68.2)(7.5) = 0.64 \text{ m}^3/\text{s}$$

$$V_{\text{estimated}} = 1.5(Q_{\text{post}})D = 1.5(.64)(3,600) = 3,456 \text{ m}^3$$

Table 9.10 Summary table of calculations.

Parameter	Pre-development	Post-development
Q ₂	0.13 m ³ /s	0.32 m ³ /s
V ₂		1,728 m ³
Q ₁₀	0.25 m ³ /s	0.64 m ³ /s
V ₁₀		3,456 m ³
Water quality volume		984 m ³
ED volume (1.2 x WQ *V)		1,181 m ³

The key elements of the table are the pre-development peak discharges and post-development volumes. The peak discharges cannot exceed the pre-development peak discharges but the volumes to be stored are the post-development ones.

Pond design

An essential component of pond design is knowing what the available storage is at the pond location. As such, it is important to develop a stage-storage relationship table to calculate the volumes versus depths for storage and discharge purposes.

For this site Table 9.11 reflects available site storage.

Table 9.11 Stage-storage relationships.

Elevation	Available volume
51.5	0
52	500
53	1,400
54	2,900
55	5,600
56	7,500

As the pond will discharge 1.2 times the water quality volume over a 24-hour period, the permanent water quality volume can be reduced by 50%.

The adjusted water quality volume is 492 m³ and rises to elevation 52.

The sediment forebay must contain a volume of at least 30% of the adjusted water quality volume, so **the sediment forebay must contain 148 m³**.

The lowest outlet is the extended detention outlet, whose invert is set at a level that impounds the required permanent water quality storage (492 m³) and the live storage for extended detention (900 m³). In this case **the elevation of the extended detention volume and water quality volume (1,673 m³) is at elevation 53.2**.

The extended detention (ED) outlet is sized to release the extended detention volume (EDV) over a 24-hour period. To do this, the outlet is sized so that when the pond is holding the full EDV the release rate is the following:

$$Q_{ED} = 1,181 \text{ m}^3 / 24 \text{ hours} = 0.01 \text{ m}^3/\text{s}$$

At the full EDV elevation, the maximum release rate is assumed to be $Q_{\max} = 2Q_{ED}$.

$Q_{\max} = 0.02 \text{ m}^3/\text{s}$. The discharge through the ED outlet cannot exceed $0.02 \text{ m}^3/\text{s}$ or the detention time will not meet the 24 hour requirement.

Calculate the low flow orifice by assuming an orifice size and ensuring that the outlet discharge does not exceed Q_{\max} .

$$Q = 0.62A(2gh)^{0.5} \text{ where } A = \text{area of ED orifice}$$

Try an orifice size of 100 mm diameter

Where $h = 53.2 - (52 + .05)$ where D is the ED outlet diameter $h = 1.17 \text{ m}$

$$Q = 0.62(0.00785)((2)(9.8)(1.15))^{0.5} = 0.023 \text{ m}^3/\text{s} \text{ which is too large}$$

Try an orifice size of 90 mm

$Q = 0.019$ which meets the design criteria. As the orifice size is greater than 50 mm, a cover plate or screen is not required to prevent clogging of the orifice but is still recommended.

ED orifice is 90 mm.

Consideration of two and ten-year storm control will consist of consideration of a rectangular weir to provide for the appropriate outflow rates. Peak outflows should not exceed the pre-development peak discharges which are $0.13 \text{ m}^3/\text{s}$ and $0.25 \text{ m}^3/\text{s}$.

To size the weir we can ignore the outflow that occurs during the rainfall and size the weir so the entire run-off volume can be held with the outflow rate not exceeding the pre-development peak flows. Routing of flows through the pond is also acceptable for this calculation but not for determining the ED volume sizing.

Two-year event

Pond volume required for the post-development case = 492 (WQ vol.) + 1,728 (two-year post-development volume) = 2,220 m^3

Ponded water level is at 53.5 m.

Outflow must be determined using the ED orifice and an outlet structure (rectangular weir).

Weir invert level is at elevation 52.8 m.

$$\text{Outflow from ED orifice} = Q = 0.62A(2gh)^{0.5}$$

$$h = 53.5 - (52 + 0.09/2) = 1.45 \text{ m}$$

$$Q_{ED} = 0.62(.0063)((28.42)^{0.5}) = 0.02 \text{ m}^3/\text{s} \text{ from ED orifice.}$$

Outflow over weir = $Q = 1.7 Lh$ where L = weir width

Try L = 220 mm

$$Q = 1.7(.225)(0.3) = 0.11 \text{ m}^3/\text{s}$$

Total outflow = ED + two-year discharges = $0.02 + 0.11 = 0.13 \text{ m}^3/\text{s}$ which meets the two-year peak control requirement.

So two-year weir width = 220 mm

ten-year event

Pond volume required for the post-development case = 492 (WQ vol.) + 3,456 (ten-year post-development volume) = $3,948 \text{ m}^3$

Ponded water level is at elevation 54.3 m

Outflow must be determined using the ED orifice and the two-year weir control.

Outflow from ED orifice = $Q = 0.62A(2gh)^{0.5}$

$h = 54.6 - (52 + 0.09/2) = 2.55 \text{ m}$

$Q_{ED} = 0.62(.0063)((49.98)^{0.5}) = 0.027 \text{ m}^3/\text{s}$ from ED orifice.

$Q_{ED} = 0.027 \text{ m}^3/\text{s}$

two-year weir flow = $1.7 Lh = 1.7(.22)(1.1) = 0.41 \text{ m}^3/\text{s}$.

Total peak discharge using two-year weir and ED orifice = $0.41 + 0.027 = 0.44 \text{ m}^3/\text{s}$ which exceeds the ten-year maximum discharge criteria ($0.25 \text{ m}^3/\text{s}$). There is little difference between the extended detention requirement and the two-year peak control rainfalls so the two-year weir can be fairly large (220 mm) and meet the two-year peak control requirement. The ten-year rainfall is considerably larger and the elevational difference in storage means that the two-year weir width must be decreased to meet the two-year peak control requirements. The advantage is that a weir having a width of 130 mm will control the two- and ten-year storms.

So, the design has an extended detention orifice of 90 mm and a broad crested weir having a width of 130 mm to provide control of all three storms.

9.5.15 Wetlands

Description: Wetlands are designed and constructed to capture and treat stormwater run-off through:

- Sedimentation
- Filtration
- Adsorption, and
- Biological uptake



Wetlands are complex natural water environments that are dominated by hydrophytic (water loving) vegetation. They differ from stormwater wet ponds that are dominated by large areas of open water

Until recently, the filling and draining of wetlands was accepted practice to “improve” land. We now know that wetlands provide many important benefits including the attenuation of flood flows, maintenance of water quality and support aquatic life and wildlife.

Stormwater Management Function

<input checked="" type="checkbox"/>	Water quality
	<input checked="" type="checkbox"/> Metals
	<input checked="" type="checkbox"/> Sediment
<input checked="" type="checkbox"/>	<input checked="" type="checkbox"/> TPH
<input checked="" type="checkbox"/>	Flood protection
<input checked="" type="checkbox"/>	Stream channel erosion protection

Constructed wetlands have become increasingly popular in recent years for improvement of water quality. Wetlands can be designed to accomplish a number of purposes and Wong *et. al*, (1998) provides the following list of purposes and benefits that are commonly combined:

- Flood protection;
- Flow attenuation;
- Water quality improvement;
- Landscape;
- Recreational amenity; and
- Provision of wildlife habitat.

From a contaminant removal perspective, wetlands provide a number of different removal processes that are not available in deeper wet ponds. Those removal processes are listed in Table 9-12.

Table 9.12 Overview of stormwater contaminant removal mechanisms of constructed wetlands (adapted from Mitchell, 1996).

Contaminant	Removal processes
Organic matter	Biological degradation, sedimentation, microbial uptake
Organic contaminants	Adsorption, volatilisation, photosynthesis and biotic/abiotic (pesticides) degradation
Suspended solids	Sedimentation, filtration
Nitrogen	Sedimentation, nitrification/denitrification, microbial uptake, plant uptake, volatilisation
Phosphorus	Sedimentation, filtration, adsorption, plant and microbial uptake
Pathogens	Natural die-off, sedimentation, filtration, predation, UV degradation, adsorption
Heavy metals	Sedimentation, adsorption, plant uptake

A key benefit of a stormwater wetland is its shallow nature. The shallow nature promotes dense vegetation growth that acts as a natural barrier to small children or the general public. Being shallow water systems, they do not have the safety concerns that deeper ponds have. Fewer safety concerns are an important consideration in selecting wetlands for water quality treatment.

Two types of wetlands will be discussed in this section: wetland ponds and wetland swales.

Basic design parameters

It is important to specify the contaminants that a stormwater treatment wetland is designed to treat, as effective treatment of different contaminants can require markedly different detention times within the wetland.

Suspended solids are at one end of the treatability spectrum and require a relatively short detention time to achieve a high degree of removal. At the other end of the treatability spectrum are nitrogen and phosphorus. Given sufficient area and time, wetlands are capable of removing nutrients to very low levels but their efficiency depends on their design.

The most common design priority for vegetated wetlands will be for the removal of:

- Sediments;
- Hydrocarbons;
- Dissolved metals; and
- Nutrients.

Wetlands are most appropriate on sites that meet or exceed the following criteria:

- Catchment areas at least two hectares in size (Table 6.2);
- Soils that are silty through clay;
- No steep slopes or slope stability issues;
- No significant space limitations.

Hydrology is the single most important criterion for determining the success of a constructed wetland. They should therefore only be used in areas that have enough inflow from rain, upstream run-off or groundwater to ensure the long-term viability of wetland processes.

Design parameters for wetlands are the same as the parameters for wet ponds in the context of storm peak control and stream channel erosion control. So the same design procedures need to be gone through. There is some difference in water quality sizing related to the following:

- Depth of standing water;
- Water quality volumes; and
- Duration of stormwater outflow.

Depth of standing water

Wetlands are shallow water systems and do not contain large volumes of water per surface area as do wet ponds.

The designed approach for a constructed wetland is the banded bathymetric design as detailed in Figure 9-25. A banded bathymetric design is preferred for having variable depth that allows for dispersed flow of stormwater through vegetation and has deeper areas for fish, which will assist in preventing mosquito problems from resulting.

The proposed depth ranges and areas for a vegetated wetland having a banded bathymetric design are the following:

<i>Banded bathymetric design</i>	<u>% total wetland pool area</u>
Dead storage 0.5–1.0 m depth	40
Dead storage at 0–0.5 m depth	60

In the event that a banded bathymetric design is not used, another approach would be to use a trapezoidal design. That design has a more uniform depth (still less than 1 m depth) and may not provide the same fisheries habitat.

Trapezoidal bathymetric design	<u>% total wetland area</u>
Dead storage at 1 m depth	20
Dead storage at 0–1 m depth	80

The banded bathymetric design is recommended over the trapezoidal bathymetric design due to its configuration providing a better expectation of uniform flow throughout the wetland. The trapezoidal design may have vegetation developing unevenly and allow for short-circuiting.

No areas of a wetland other than the sediment forebay should be deeper than 1 m.

Water quality volumes

As Table 9.12 lists the variety of removal processes that wetlands use to remove contaminants, sedimentation is only one of those processes with the others relying on contact between stormwater contaminants and plants and organic matter. As can be seen from Figure 9.25, wetlands are shallow water systems and rely more on surface area than on having a specific volume of storage.

Figure 9.25 - Banded bathymetric wetland schematic

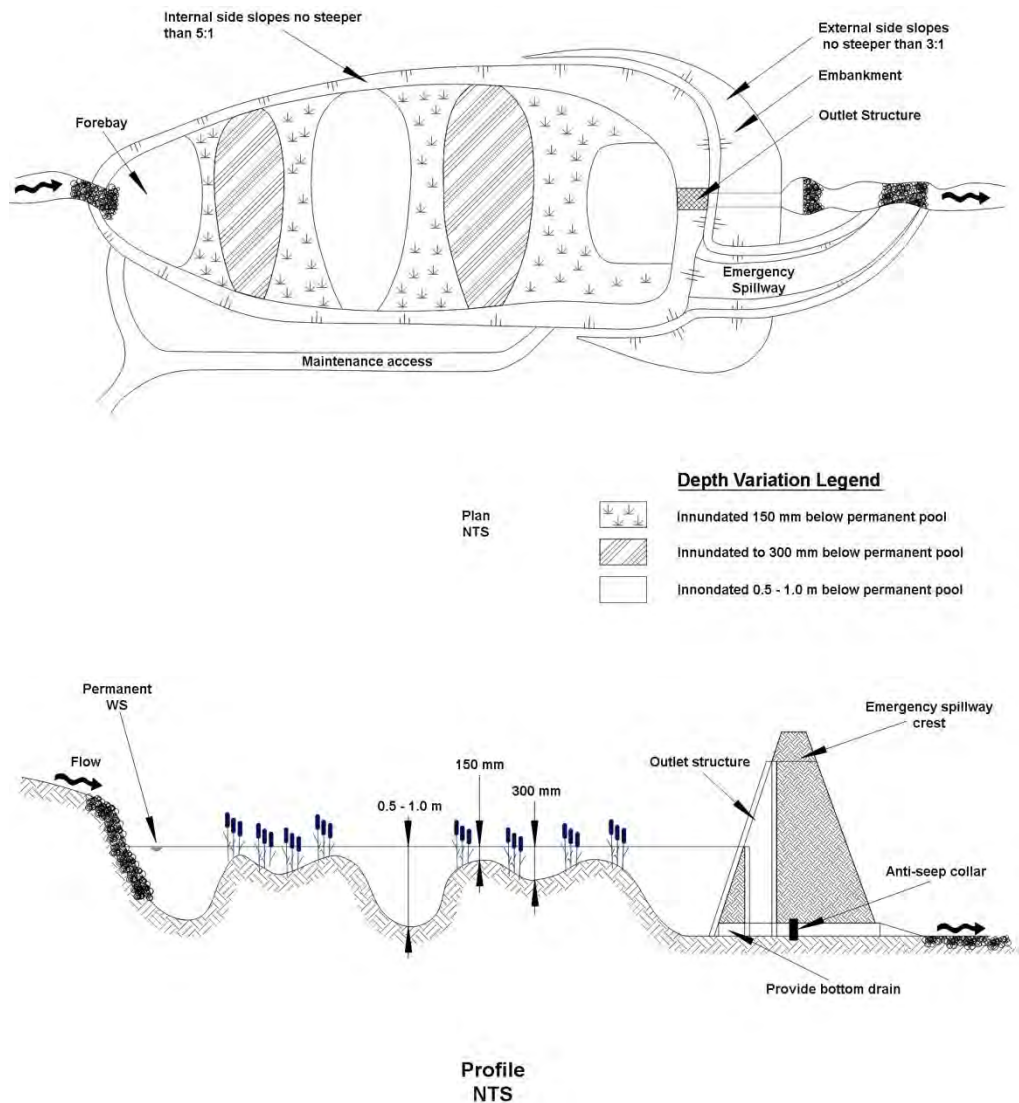

There are several approaches to considering a surface area requirement. The first approach is to use the wetland surface area as a proportion of the catchment area and a recent publication (Cappiella, Fraley-McNeal, Novotney, Schueler, 2008) recommends a ratio of wetland area to catchment area of 3%. In a similar fashion a report out of Australia (Wong, Breen, Somes, Lloyd, 1999) relates hydrologic effectiveness to wetlands having a surface area as a percentage of catchment area and indicates a desirable ratio of approximately 2% for a catchment of 30% imperviousness and a 72-hour detention time for nitrogen reduction.

Another approach is to relate hydrologic effectiveness to wetland storage as a percentage of annual run-off volume. The same report (Wong, et. al 1999) shows a “knee” point of approximately 2% where benefits start to wane for further increases in storage. Again, this design is based on the removal of nutrients as a key objective.

As a result the recommended approach for wetland design is to have the surface area of the wetland as 2% of the overall catchment area draining to the wetland.

Duration of stormwater outflow

Research in Australia ((Wong, Breen, Somes, Lloyd, 1999) has indicated that detention times for significant levels of nutrient removal. The duration of outfall is recommended to be 72 hours, which greatly exceeds the extended detention period for downstream stream channel erosion protection.

Where developments are proposed in the Rotorua Lakes Catchment areas, extended detention of outflow for the water quality storm should extend for a period of 72 hours to facilitate removal of nitrogen and phosphorus. For developments in other areas, detention of flow is only required where stream channel erosion is a concern and then detention should occur over a time period of 24 hours.

Detailed design procedure

The design basis for a stormwater wetland is twofold:

- Water quality objectives are achieved by sizing the wetland surface area to 2% of the catchment drainage area draining to the wetland. The wetland depths are then provided through the relative depths provided in the above depth discussion.
- Extended detention of the water quality storm or 1.2 times the water quality storm for a drawdown over 24 hours by doing the same calculations as the wet pond section. In the Rotorua Lakes Catchment areas, drawdown of the water quality storm should occur over a 72-hour period.
- Intermediate storm control and extended detention objectives are met through the same calculations discussed in the wet pond section.

The design steps are the following:

- 1 Calculate the wetland surface area as at least 2% of the contributing catchment area.
- 2 The shape of the wetland should generally be that its length should be at three times its width. These criteria can be relaxed if extended detention were required as flows will be significantly reduced and the length to width ratio is not as important.
- 3 Using the depth discussion above ensure that the percentage of wetland depths meet the above criteria with a banded bathymetric design being preferred.
- 4 Calculate the water quality volume that the wetland would have in an identical approach to the wet pond water quality volume. Take 15% of that volume as the necessary volume of an emergency spillway. The surface area determined from this approach can reduce the wetland surface area, as the two areas together will meet the 2% criteria.

- 5 Determine whether the project needs peak flow control, stream channel erosion control or extended detention for nutrient removal through extended detention.
- 6 Do calculations identical to the wet pond design for extended detention release sizing and outlet sizing for the two and ten-year storms.

Table 9.13 provides a list of plant species for general consideration. Plants for a given project should be considered for suitability in the BOPRC region.

Table 9.13 List of plant species.

Following is a list of the preferred wetland vegetation and its normal depth:	
<u>Deep zone 0.6–1.1 m</u>	
<i>Baumea articulata</i>	<i>Typha orientalis</i> (Raupo)
<i>Eleocharis sphacelata</i>	<i>Myriophyllum propinquum</i> (Water milfoil)
<i>Schoenoplectus validus</i>	<i>Potamogeton cheesemanii</i> (Manihi)
<u>Shallow zone: 0.3-0.6 m</u>	
<i>Baumea articulata</i>	<i>Schoenoplectus validus</i>
<i>Bolboschoenus fluviatilis</i>	<i>Typha orientalis</i>
<i>Eleocharis sphacelata</i>	<i>Isolepis prolifer</i>
<i>Eleocharis acuta</i>	<i>Juncus gregiflorus</i>
<i>Carex secta</i>	
<u>Wet margin 0-0.3 m</u>	
<i>Baumea teretifolia</i>	<i>Juncus gregiflorus</i>
<i>Baumea rubiginosa</i>	<i>Carex virgata</i>
<i>Carex secta</i>	<i>Cyperus ustulatus</i> (Giant umbrella sedge)
<i>Eleocharis acuta</i>	<i>Phormium tenax</i> (Flax)
<u>Live storage zone (periodically inundated)</u>	
<i>Syzygium maire</i> (Swamp maire)	<i>Dacrycarpus dacrydioides</i> (Kahikatea)
<i>Carex virgata</i>	<i>Cordylina australis</i> (Cabbage tree)
<i>Carex lessoniana</i> (Rautahi)	<i>Baumea rubiginosa</i>
<i>Carex dissita</i> (Flat leaved sedge)	<i>Phormium tenax</i> (Flax)
<i>Cyperus ustulatus</i>	<i>Coprosma tenuicaulis</i> (Swamp coprosma)
<i>Juncus articulatus</i>	<i>Blechnum novae-zelandiae</i> (Swamp kiokio)
<u>Land edge</u>	
<i>Coprosma robusta</i> (Karamu)	<i>Schefflera digitata</i> (Pate)
<i>Phormium tenax</i>	<i>Meliccytus ramiflorus</i> (Mahoe)
<i>Cordylina australis</i>	<i>Pneumatopteris pennigera</i> (Gully fern)
<i>Carpodetus serratus</i> (Putaputa weta)	<i>Dacrycarpus dacrydioides</i> Kahikatea)
<i>Laurelia novae-zelandiae</i> (Pukatea)	<i>Cortaderia fulvida</i> (toetoe)
<i>Leptospermum scoparium</i> (Manuka)	

Wetland swale design

Wetland swales consist of broad open channels in areas where slopes are slight, water tables are high or, on a seasonal basis, there is base flow, and there are saturated soil conditions. If soil is saturated for more than two weeks, normal grasses will not grow.

Wetland swales are similar to normal constructed wetlands in their use of vegetation to treat stormwater run-off. The wetland swale acts similarly to a long and linear shallow wetland treatment practice. Figure 9.26 shows a typical cross section for a wetland swale.

Figure 9.26 – Cross section of a wetland swale (adapted from CWP, 2001)

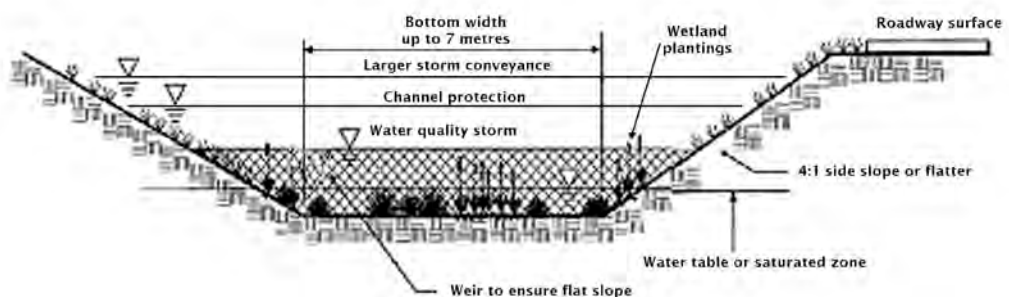

Design considerations

There are two separate approaches that can be used for sizing wetland swales.

- Storage of the water quality volume generated by the upstream catchment; or
- Ensuring wetland swale residence times exceed nine minutes.

For the purposes of this guideline, the recommended approach is ensuring residence times exceed nine minutes. As the wetland swale will, for the most part, have water in it with standing vegetation, the vegetation may not be as dense as vegetation in a normal vegetated swale. This will result in using a Manning's roughness coefficient of 0.1.

As a result, wetland swales will either be longer or wider than normal vegetated swales. There are several key design elements to a wetland swale.

- As there is no concern about wider channels concentrating flow at one point (as in normal swales), a wetland swale can be up to 7 m wide.
- Due to a reduced roughness coefficient, a length to width ratio of 5 horizontal: 1 vertical should be provided.
- If there is a longitudinal slope, check dams must be used to stem the flow, ensure a level bottom on the wetland swale and maintain very shallow side slopes.

Wetland swale with check dams prior to placement of substrate and plants



A schematic of a wetland swale with check dams is shown in Figure 9.27. Even though there is a longitudinal slope, the check dams ensure a level invert elevation.

Figure 9.27 - Longitudinal slope on a wetland swale

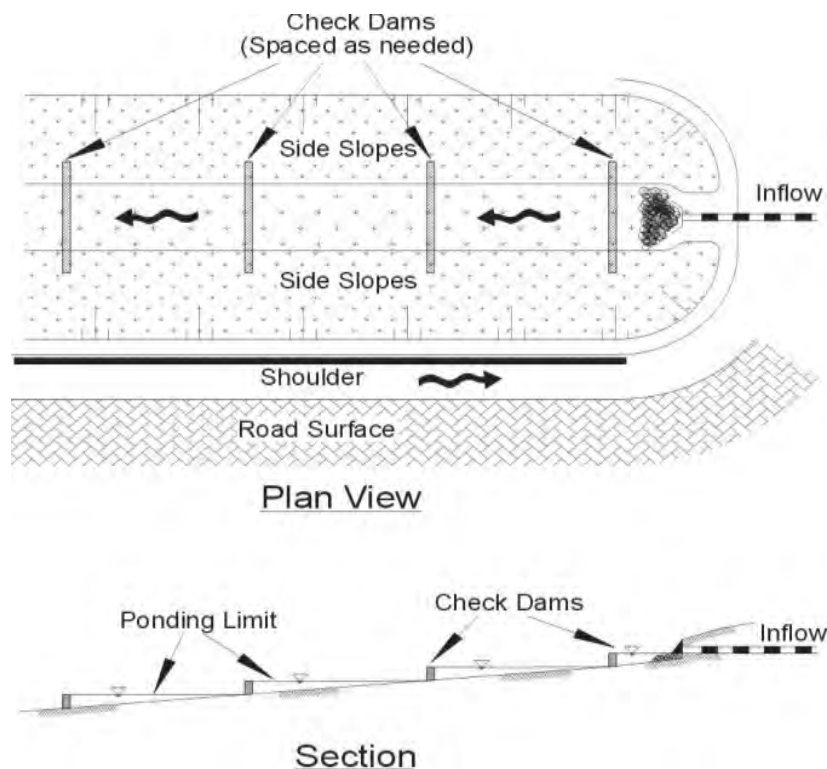

Targeted contaminants

Wetland swales are effective at removing suspended sediments and metals. They provide a moderate removal of nutrients and are less effective at removal of oil and grease. Due to their use on small catchment areas, 72-hour detention time for nutrient removal is not practical, so expectations for nutrient removal are reduced from what would be expected of a constructed wetland system. Estimates for a treatment train approach would be 15% nitrogen removal and 25% phosphorus removal.

Advantages

Wetland swales can have the following advantages.

- Having an outlet structure for the wetland swale can provide for peak flow control and extended detention;
- They can accentuate the natural landscape;
- Contaminant removal efficiency can be improved over a normally dry swale; and
- They enhance biological diversity and create beneficial habitat between upland areas and streams.

Limitations

Wetland swales are not practical in areas of steep topography and are not practical when driveway crossings are required unless significant opening areas are provided.

Design sizing

The design approach takes the designer through a series of steps that consider swale performance for water quality treatment and consideration of larger flows to ensure that scour or re-suspension of deposited sediments does not occur.

- 1 Estimate run-off flow rate from the water quality storm using the two-year, one-hour storm as the water quality storm and calculate the flows. Wetland swales are designed by flow rate as discussed in Section 9.5.1.
- 2 Design should use the Rational Formula.
- 3 Establish the longitudinal slope of the wetland swale. The maximum slope (with or without check dams) should be less than 2%.
- 4 Select wetland vegetation cover. Types of wetland vegetation to recommend are detailed Table 9.13.
- 5 The value for Manning's coefficient of roughness for wetland swales is 0.10.
- 6 Select a swale shape. Two shapes are proposed as they ensure distributed flow throughout the bottom of the swale. Of the two shapes, the trapezoidal shape is recommended. Channel geometry and equations for calculating cross-sectional areas and hydraulic radius are provided under the individual configurations in Figure 9.28.

Figure 9.28 - Channel geometry

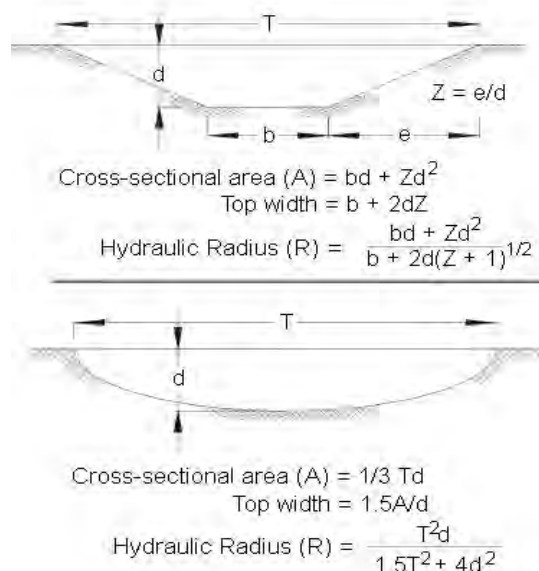

- 7 An assumption is made on the normal pool and live storage depth of flow for the water quality storm. This assumed depth is used for calculating the bottom width of the wetland swale and cross-sectional area.

- 8 It is not required to have a normal pool elevation for a wetland swale but it is important to have a saturated subgrade for wetland plants to thrive. If it can be documented that groundwater is at the surface for the entire year, then a wetland swale is very appropriate.
- 9 Use Manning's equation for calculating dimensions of the swale by using first approximations for the hydraulic radius and dimensions for selected shape.

$$Q = AR^{0.67}s^{0.5}/n$$

By making some assumptions about depth and width ratios such as the hydraulic radius for a trapezoid approximating the depth (d), the bottom width of a trapezoid (b) equals the following:

$$b = (Qn/d^{1.67}s^{0.5}) - Zd$$

The slope, depth, discharge and side slope are all known and b can be determined.

Where:

- Q = Design discharge flow rate (m³/s)
 n = Manning's n (dimensionless)
 s = Longitudinal slope (m/m)
 A = Cross-sectional area (m²)
 R = Hydraulic radius (m)
 T = Top width of trapezoid/parabolic shape (m)
 d = Depth of flow (m)
 b = Bottom width of trapezoid (m)

For a parabola, the depth and discharge are known so the top width can be solved for.

- 10 Knowing b (trapezoid) or T (parabola), the cross-sectional area can be determined by the equations in Figure C2.
- 11 Calculate the swale velocity from the following equation:

$$V = Q/A$$

If $V > 0.8$ m/s repeat steps 1-9 until the velocity is less than 0.8 m/s.

- 12 Calculate the swale length (L in metres)

$$L = Vt \text{ (60 s/minute)}$$

Where t = residence time in minutes.

Flows in excess of the water quality storm

It is expected that run-off from events larger than the water quality design storm will go through the wetland swale. In that situation, a stability check should be performed to ensure that the ten-year one-hour storm does not cause erosion. For the ten-year storm, flow velocities should not exceed 1.5 m/s, although higher velocities may be designed for with appropriate erosion protection. When considering larger storms consideration must be given to increased rainfall values as a result of climate change. Table 7.3 provides information on the percentage increase for design purposes.

If extended detention and/or peak flow control is a requirement for a specific project, the outlet of the wetland swale can be modified so that storage volumes are provided.

9.5.16 Case studies

Wetland swale case study

Project description

An access road, driveways and pasture for a three-lot rural subdivision in Rotoiti is proposed to drain to a wetland swale. The lane is 6.4 m wide and 400 m long, the three driveways are each 3.4 m wide and 75 m long and the pasture area is approximately 10,000 m².

Hydrology

Using the Rational Formula

$$Q_{wq} = 0.00278CIA$$

Predevelopment land use is pasture on a 2-7% slope

C = 0.38 (at variance from Table 7.1 due to rural nature of project)

I = Rainfall intensity (mm/hr) – the WQ design storm is 15.3 mm

A = catchment area in hectares = 1.33 ha

$$Q_{wq} = 0.00278(0.38)(15.3)(1.33) = 0.02 \text{ m}^3/\text{s}$$

For the one hour Q₁₀, rainfall is 22.8 mm. Effect of global warming on the ten-year storm is 15.5% increase in rainfall. So 22.8 mm for a ten-year storm increased by 7.4% x 2.1° results in 26.3 mm of rainfall.

$$Q_{10} = 0.00278(.38)(26.3)(1.33) = 0.036 \text{ m}^3/\text{s}$$

Swale Design

Slope of swale alignment = 0.02

Several assumptions have to be made regarding the swale, first of which is that the wetland swale will have a trapezoidal design. Side slopes (Z) will then be recommended and an assumption of design storm depth should be made. That value may change depending on the velocity of flow being less than 0.8 m/s.

For this case study, Z = 4 and the depth of flow = 100 mm. The static water level (or dead storage) in the wetland swale is estimated to be 100 mm deep as check dams have been designed to maintain a level bottom, but that storage cannot be considered in terms of flow velocities. Since storm flow will overtop the check dams, the slope to use in calculations is the longitudinal slope and not permanent water elevation slope.

Based on the value for Q and s, and the assumptions for n and d, solve for the swale bottom width (b).

$$b = (Qn/d^{1.67}s^{0.5}) - Zd$$

$$b = ((.02)(.1)/(.1^{1.67})(.02^{0.5})) - (4)(.1) = 0.29 \text{ m}$$

Calculate the top width

$$T = b + 2dZ = 0.97 + 2(.1)(4) = 1.09 \text{ m}$$

Calculate the cross-sectional area

$$A = bd + Zd^2 = (0.97)(.1) + 4(.1^2) = 0.069 \text{ m}^2$$

Calculate the flow velocity

$$V = Q/A = 0.02/0.069 = 0.29 \text{ m/s which is under than the } 0.8 \text{ m/s maximum - good.}$$

Calculate the wetland swale length

$$L = Vt = 0.29(540 \text{ sec.}) = 156.6 \text{ m long}$$

The wetland swale length can be reduced significantly if it were made wider. A wetland swale can have a bottom width up to 7 m as standing water will not cause flow to concentrate in one area. As an example, if the swale bottom width were increased to 3 m, the following calculations will provide an adjusted length.

$$b = 3 \text{ m}$$

$$T = 3 + 2(.1)(4) = 3.8 \text{ m}$$

$$A = 0.34 \text{ m}^2$$

$$V = Q/A = 0.02/0.34 = 0.059 \text{ m/s}$$

$$L = 0.059 (540) = 31.8 \text{ m (124.8 m less length than the previously calculated length).}$$

As the swale will probably have larger flows pass through it, the swale design can be adjusted to account for the larger flows. In this situation the Manning coefficient of roughness will not have to be decreased as wetlands vegetation is expected to be considerably higher than the static water level, so assume $n = .1$. Solve for d and ensure that velocities are not erosive. $Q_{10} = 0.036 \text{ m}^3/\text{s}$.

$$b = (Qn/d^{1.67}s^{0.5}) - Zd$$

$$0.29 = (0.36(.1)/d^{1.67}s^{0.5}) - 4d$$

By trial and error, the wetland swale must have a depth of 135 mm to convey the ten-year storm.

$$A = bd + Zd^2 = (0.29)(.135) + 4(.135)^2 = 0.11 \text{ m}^2$$

$Q = AV$ or $Q/A = V = 0.1 \text{ m}^3/\text{s}/0.35 = 0.33 \text{ m/s}$ so the velocities during the ten-year storm are non-erosive.

Wetland pond case study

The case study is the same case study as the wet pond design using the City of Tauranga as the location but designing a wetland instead.

Project description

The same development as designed in the wet pond section is proposed but using a wetland pond. It is 7.5 ha in size with no off-site drainage passing through it. It has gentle slopes and average imperviousness is expected to be 50%. Pre-development land use is pasture. The site drains into a stream channel so extended detention is a design component.

The total catchment area is 7.5 ha and the soils are typical clay soils. Pre-development adjacent land use is pasture and the site drains to the upper part of a stream:

- Peak flow control of the two and ten-year storms
- Extended detention of 1.2 x WQ storm
- Water quality treatment

Hydrology

Water quality storm is 25 mm of rainfall

Two-year one-hour rainfall is 30 mm

Ten-year one-hour rainfall is 59 mm

The following table 9-14 is from the wet pond case study.

Table 9.14 Wet pond case study summary table.

Parameter	Pre-development	Post-development
Q_2	0.13m ³ /s	0.32 m ³ /s
V_2		1,728 m ³
Q_{10}	0.25 m ³ /s	0.64 m ³ /s
V_{10}		3,456 m ³
Water quality volume		984 m ³
ED volume (1.2 x WQ *V)		1,181 m ³

Wetland design

Water quality Volume = 984 m³ and the wetland forebay must be 15% of the water quality volume.

Sediment forebay size is 148 m³.

The surface area of the wetland will be 2% of the contributing catchment area, which is 7.5 ha.

Wetland surface area is 1,500 m²

Since extended detention is a design requirement, the length to width ratio is not as important but for this case study a length to width ratio would provide a general shape of approximately 25 m wide by 75 m long.

To have the depths defined we use the relationships provided above.

Banded bathymetric design	Total wetland pool area (%)	Area extent (m ²)
Dead storage 0.5–1.0 m depth	40	600
Dead storage at 0–0.5 m depth	60	900

The forebay volume can be taken from the deeper dead storage so if the forebay is 1.5 m deep, the surface area is 98 m² so the dead storage for other areas of the wetland deeper than 0.5 m = 502 m³.

Figure 9.29 shows this visually.

Figure 9.29 - Case study percentage areas

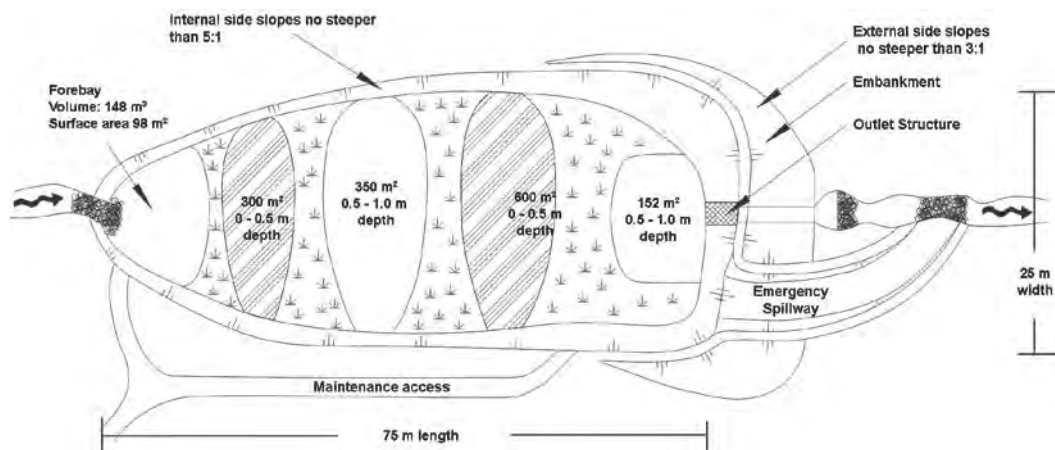

As the forebay elevation is considered part of the wetland surface area, the areas detailed in the banded bathymetric design have been reduced proportionally to account for the forebay area. If the individual areas are added together the total recommended levels are achieved.

- 1 Extended detention design and peak storm control are done identically as the wet pond design detailed design procedure. They are not replicated here but are detailed in the Wet Pond Case Study section under the Extended Detention and two and ten-year sections of the case study.
- 2 If the wetland were in the Rotorua Lakes Catchment Area, the ED volume would have to be released over a 72-hour period. The ED volume is 1,181 m³ or 0.0045 m³/s or a maximum release rate of 0.009 m³/s. Using the orifice equation, the ED orifice size is approximately 70 mm in diameter.

9.5.17 Green roofs

Description of practice

Description: Green roofs are roofs with a growing media that reduces stormwater run-off through evaporation and evapotranspiration. Their primary benefit from a stormwater management perspective is to reduce the total volume of stormwater run-off.



Green roofs are roof systems that incorporate a growing media and plants to provide a semi-permeable surface on roofs that would normally consist of impervious surfaces. A green roof more mimics a natural environment to filter precipitation through the media and allowing for the wetted media to evapotranspire between storm events. A green roof may eliminate run-off during small rainfall events and will retard the onset of stormwater run-off and increase the time of concentration from a conventional roof, thus reducing downstream stormwater effects.

Stormwater Management Function



Water quality

✓

Metals

✓

Sediment



Flood protection



Stream channel erosion protection

Design considerations

Typically, as shown in Figure 9.30, a green roof consists of the following:

- A waterproof membrane to prevent water from leaking into the structure;
- A drainage layer to allow lateral movement of water to the down spout;
- Filter media for passage of stormwater and a growth media for plants;
- Mulch or other material to prevent surface wind and rain erosion; and
- Plants.

Figure 9.30 - Green roof cross-section showing elements

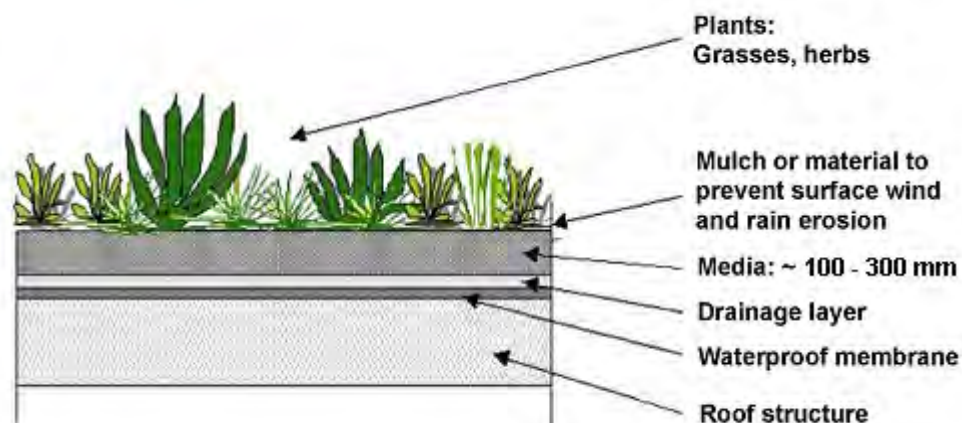

Green roofs are engineered systems, which address all of the critical aspects of design, including the following:

- The saturated weight of the system and load bearing capacity of the underlying roof;
- Moisture and root penetration resistance through use of a waterproof membrane;
- Resistance to wind shear, management of drainage; and
- The suitability of the proposed plant material.

There are generally considered to be two types of green roofs.

- Extensive green roofs, which are shallow systems having less than 100 mm of media, which are not being advocated by this toolbox; and
- Intensive green roofs, which are deeper systems having more than 150 mm of media.

Targeted contaminants

From a water quality perspective, green roofs would be effective in retention of fine, windblown sediments and dissolved metals.

Advantages

Overseas data indicates that green roofs can be very effective at reducing the total volume of stormwater run-off. A study in North Carolina (Moran, Hunt and Smith, 2005) indicated that a green roof retained 45% of total annual run-off. Recent monitoring efforts by the ARC on the University of Auckland Engineering Building green roof have indicated the following:

- Depth of media between 50-70 mm;
- 83 storms were monitored over 13 months;
- 87% average reduction in peak flow rate;
- 68% of rainfall doesn't become run-off; and
- 80% retention for storms less than 25 mm of rainfall.

Green roofs can be used on a variety of roof types and on any property size, as their installation will not require the use of additional land. With the Bay of Plenty temperate climate, green roofs should not be limited by the ability to establish and maintain vegetative cover.

Another key advantage of green roofs is that they are aesthetically pleasing. They can be very attractive. There are also benefits related to urban cooling during the summer months and insulation benefits for air conditioning and heating.

Limitations

There are several issues that may be considered as limitations.

- Green roofs, as recommended in this guideline, will necessitate increased structural strength of the roof that would increase costs.
- Maintenance needs, while expected to be minimal, may be costly and difficult depending on height above ground.
- Establishment of plants and their overall survival may require watering during dry periods, at least for the first several years.
- Weed removal may be a requirement depending on individual conditions.

Design sizing

There are several key elements of design that need to be addressed.

- Depth of media;
- Composition of media;
- Plant selection;
- Additional support consideration;
- Roof slope;
- Drainage layer and impermeable liner; and
- Stormwater management benefits.

Depth of media

There are two green roofs in the Auckland region that are being studied for water quantity and quality benefits: the University of Auckland Engineering Building green roof, and the Waitakere City Council Headquarters building green roof.

While these are both fairly new installations, some guidance can be given on plant propagation that relates to the depth of media. The University of Auckland site has media between 50-70 mm in depth.

Over the 2007-2008 summers, plants were severely stressed due to the lack of moisture in the shallow subgrade. The Waitakere City green roof fared much better due to its depth being 70-150 mm.

Deeper media depths are better than shallower ones.

It is recommended that there be at least 150 mm of media to promote a sustainable plant community.

Waitakere City Council Building green roof



Composition of media

The University of Auckland site investigated a number of different media and has found that the mixture of the following provides the best results and that mixture is recommended for use.

- 30% zeolite;
- 50% pumice; and
- 20% composted bark.

Plant selection

New Zealand does not have any native succulents, which is the plant of choice internationally due to their ability to thrive in both wet and dry conditions. There are New Zealand plants that are suitable for green roofs, especially with the recommended depth of media being at least 150 mm.

Recommended plants include the following:

- *Disphyma australe* (New Zealand ice plant)
- *Pimelea prostrata* (New Zealand Daphne)
- *Libertia peregrinans* (New Zealand iris)
- *Festuca coxii* (native tussock)
- *Comprosmia Hawera*
- *Acaena microphylla* (New Zealand bidibid)
- *Lepostigma setulosa*

Other plants will be acceptable, but a plant specialist should be consulted prior to use due to the shallow media depths and the extremes of wetting and drying that will be encountered.

Additional support consideration

The additional load of materials comprising the various components and an assumption of having saturated media conditions needs to be considered when accommodating the roof's structural load. The calculation has to be based on an assumption of a saturated state.

A Chartered Professional Engineer must be consulted in the design and construction of a green roof system.

Roof slope

Generally, the construction effort and cost of green roofing increases with slope. Minimal slopes slow down water flow and slopes above 5° will have more rapid run-off. Due to native plants not providing the density of vegetation that would bind the media, it is recommended that green roof slopes not exceed 5° unless steps are taken to prevent media slippage and erosion.

Drainage layer and impermeable liner

The drainage layer should be a Delta NP drainage layer, or equivalent, with a nonwoven geotextile, which is a two-layer drainage and waterproofing system with the cloth facing the media.

The impermeable liner should be Permathene flexible polypropylene geomembrane (0.25 mm), or equivalent.

Both of these products can be substituted for if the substitution meets the same standards as the two presented.

Stormwater management benefits

Green roofs provide an excellent media for water quality treatment of any airborne contaminants and thus meet water quality treatment guidelines.

The media recommended includes zeolite, which is a hydrated aluminosilicate mineral having a micro-porous structure. Pumice also has a very high porosity and being highly porous is very lightweight. Design can assume a 50% void ratio for the compost bark, zeolite and pumice.

Stormwater quantity control is not required for green roofs.

Case study

This is a typical green roof design is shown in Figure 9.31.

9.5.18 Water tanks

Description of practice

Description: Water tanks provide detention storage for stormwater run-off and water supply for domestic use. They reduce stormwater run-off through domestic use and thus reduce the total volume of stormwater being discharged during a storm event.

A water tank is a storage receptacle for stormwater run-off that is generated from roof areas. The stored water can then be used for site needs.

The primary function of water tanks in a rural area is to provide water supply for residential, commercial and industrial use. In addition to the water supply benefits water tanks also reduce the total volume of stormwater run-off by redirecting the run-off to a storage tank for subsequent use for site water needs.

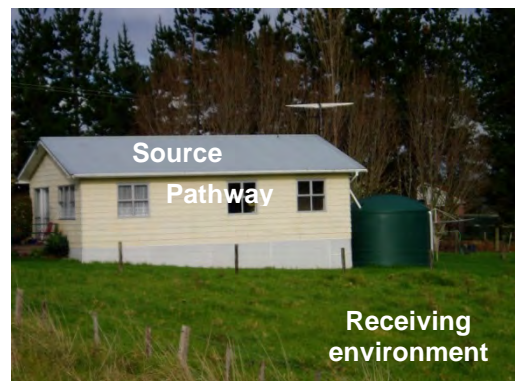

Stormwater Management Function

<input checked="" type="checkbox"/>	Water quality
	<input checked="" type="checkbox"/> Metals
	<input checked="" type="checkbox"/> Sediment
<input type="checkbox"/>	Flood protection
<input checked="" type="checkbox"/>	Stream channel erosion protection

Figure 9.31 - Case study parameters for a green roof

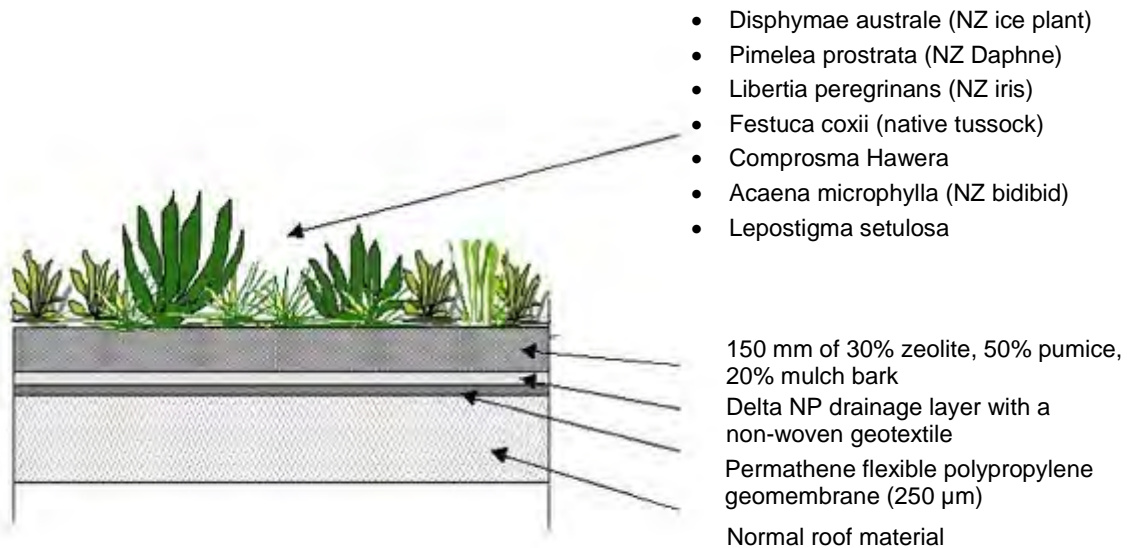

The primary function of water tanks in an urban area is to augment water supply for residential, commercial and industrial use. In addition to the water supply benefits water tanks also reduce the total volume of stormwater run-off by redirecting the run-off to a storage tank for subsequent use for site water needs. In an urban environment there are a number of benefits to using a water tank:

- Cost savings depending on size and water use;
- Good management of natural resources;
- Delayed investment in new Council infrastructure;
- Reduced volume and peak flow of stormwater run-off entering streams and harbours; and
- Reduced possibility of sewer overflows.

In terms of source, pathway and receiving environment, the source of stormwater is the structure roof, with the pathway being the gutters and down pipes and the water tank is the receiving environment.

It is recognised that in many situations the water tank may be the only source of water for a given site. As such, the tank water will be used for potable purposes. This can involve several health and safety related issues including treating and disinfecting the roof run-off to meet appropriate water quality standards. It is suggested that professional assistance be solicited in these situations. For more information it is suggested that a copy of the Ministry of Health's "Household Water Supply" (2004) document be read.

If rainwater is being used for indoor purposes, it is likely that rainwater will need to be supplemented by Council mains supply to guarantee a regular supply.

There are two options for doing this:

- Topping up the tank from mains into the top of the tank. This requires an appropriate air gap between the tank and top up pipework.
- Direct connection to mains water top up. This requires a testable backflow prevention device and local water suppliers must be contacted to discuss the requirements.

Any outdoor taps must have signage with the wording “Rainwater – Not for Drinking” as per the Building Act. For more information it is suggested that a copy of the Ministry of Health’s “Household Water Supply” (2004) document be read.

A local Council Building Consent may be required for installation of a water tank.

Design considerations

There are a number of elements that need to be considered when designing a water tank.

- The annual average rainfall amount and inter-event dry periods;
- The roof area;
- The anticipated water use;
- The percent of water from the roof that can be used;
- Peak flow considerations; and
- Sizing outlets.

It is assumed that water tanks, in the context of this guideline, will be both full service tanks and, where water supply is provided by Council, limited to non-potable uses.

It is not intended in this guideline that roof areas compensate for impervious surfaces beyond the roof area itself.

Targeted contaminants

For the most part, rainfall in the BOPRC region is not contaminated. The major source of contamination may be from the roof materials themselves or from animal or plant organic matter. Contamination issues can be minimised by using roofing materials that don’t generate contaminants or by screening gutters for minimising the entry of organic matter.

Advantages

Water tanks have several advantages:

- They reduce the total volume of stormwater run-off by separating the site water use from stormwater run-off;
- They provide for site water use in areas where groundwater supply may be limited; and
- Through storage and use, they can provide for detention of excess flows and reduce downstream effects.
- Water tanks require minimal maintenance if filtering of roof run-off is provided through screens or first flush diverters.

Limitations

The most obvious limitation of water tanks is the potential for them to run dry during drought times, which could occur. This issue can be minimised through provision of excess storage that ensures adequate capacity during drought times. In addition during extreme drought, water can be purchased to fill the tank.

Where water tanks are the only means of providing domestic water (residential use), the minimum tank size shall be 25,000 litres.

Design sizing

As mentioned in Section 9.5.9, there is a logical progression of analysis that needs to be done for water tank sizing.

The average annual rainfall amount and the inter-event dry periods. Rainfall in the Bay of Plenty region is highly variable. A rainfall summary report (BOPRC, 24/11/09 www.envbop.govt.nz/MonitoredSites/RainfallReport.html) shows the variability of data between locations. Rainfall ranges from approximately 1,200 mm of rainfall at Otara at Ōpōtiki Wharf to 4,400 mm at Haparapara at East Cape. In terms of rainfall days for the region approximate number of days from NIWA climate summaries is 115 days of rain a year with June, July and August being the wettest months.

In terms of providing storage for rain water usage it is important to understand the period of time during the year when it doesn't rain, as tank storage will have to account for those dry times. This is considered the inter-event dry period and that time period will vary during the year. Table 9.15 provides the inter-event dry periods and shows the variation from month to month for the City of Tauranga (NIWA rainfall data from the Tauranga Airport Weather Station). Looking at the data for Rotorua gives similar results to the Tauranga City data.

Table 9.15 Inter-event dry days.

	January	February	March	April	May	June	July	August	September	October	November	December	Annual
Average	5.4	3.6	3.2	4.1	3.4	4.1	3	2.6	3.1	4.1	4.7	2.9	3.6
Medium	4	2	2	4	1	3	2	2	2	3.5	4.5	3	3
Maximum	13	21	12	15	16	9	10	10	9	16	11	7	21

Inter-event dry periods are important to consider if the water is being used for domestic or industrial use. During periods of dry weather additional water is not available so storage must be provided for those expected dry periods.

Although there is little difference in the inter-event dry period between winter and summer there is some slight difference with the average dry period in January being approximately 5.4 days. That means that the volume of storage needs to be provided for the daily-anticipated water usage multiplied by at least 6 to provide for needs during the dry periods. It must be recognised that the 6 is an average value and additional storage would provide longer-term protection. The maximum period of time could be as long as 21 days if water tanks are the sole source of water.

While this information has been somewhat extrapolated to the whole region, having site specific rainfall information would provide more accurate design assistance.

How much water can be captured from the roof

The first aspect of design is to calculate the roof area that will be drained to a water tank. Figure 9.32 details how that is done. The area that is green and covers the whole plane of the green area is the roof area that is then used in calculations.

Another component of roof run-off capture is what percentage of stormwater that runs off the roof can be used depending on roof area, tank size, daily usage and whether there are detention requirements associated with roof imperviousness.

Figure 9.32 - Calculation of roof surface area

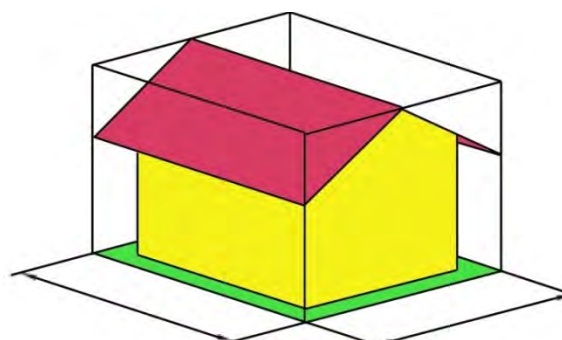

When calculating catchment area, measure at ground level below edges of the roof, including eaves

The anticipated water use

Table 9.16 provides information on anticipated water use for residential properties. The values can be extrapolated for more or less members but an average assumption of three members is reasonable given the potential of people relocating. It is recommended that water use for a residence be 325 l/d for non-potable use.

Table 9.16 Estimated residential demand based on 500 l/d for a three-member household.

Water use	Average litres/day (l/d)
Bathroom	125
Toilet	125
Laundry	100
Gardening	100
Kitchen	50
Total	500

The same assumption cannot be made for rural commercial or industrial land use. In this situation, assumptions need to be made regarding the number of people that will occupy the workplace. Table 9.17 provides information on occupancy ratios.

Table 9.17 Building Occupancy Ratios for Different Activities (NSCC, 2008).

Activity	Floor to person ratio
Office	25 m ²
Showroom	35 m ²
Warehouse	50 m ²
Shops, retail	35 m ²
Restaurant/dining areas	15 m ²
Local shopping centres	35 m ²
Manufacturing	25 m ²

The number of individuals occupying the building will be the gross floor area divided by the floor to person ratio.

The amount of water used per day is the number of individuals times 25 l/d. At a minimum the value should total 125 l/d.

Industrial sites will have to be considered on an individual basis as the industrial usage may require water use in its operation. The total expected amount of use will then be based on employee and operations usage.

The percentage of water from the roof that can be used

There will be periods of time when the water tank is full due to longer periods of wet weather. The concern related to this situation is when detention storage is required for peak discharge control. It is not an issue for domestic or business use as more water does not present a problem related to consumption.

As a guide to collection capacity, consider that each **1 mm of rain = 1 litre (l) of water per square metre (m²)** of roof area, then allow a 15% wastage factor. This will allow for a good understanding of whether the roof can provide the needed amount of water that is needed.

As an example, 1,400 mm of rainfall on a 200 m² roof would result in 280,000 litres/year – 42,000 litres = 238,000 available litres for site use. If partial site usage was 325 l/d then having an adequately sized water tank could provide for 100% of site usage while reducing stormwater run-off. If all of the water is captured, the water tank would also supply 100% for full service use.

The 15% wastage factor accounts for the time of year that the tank overflows due to rainfall exceeding tank storage.

Peak flow consideration

When sizing a water tank, there are two possible storage components.

- The water needs component, and
- An attenuation volume that reduces peak rate of discharge.

The attenuation volume occupies the upper storage area of the tank with its outlet orifice placed immediately above the water needs volume as shown in Figure 9.33.

Figure 9.33 - Combination attenuation and water use tank

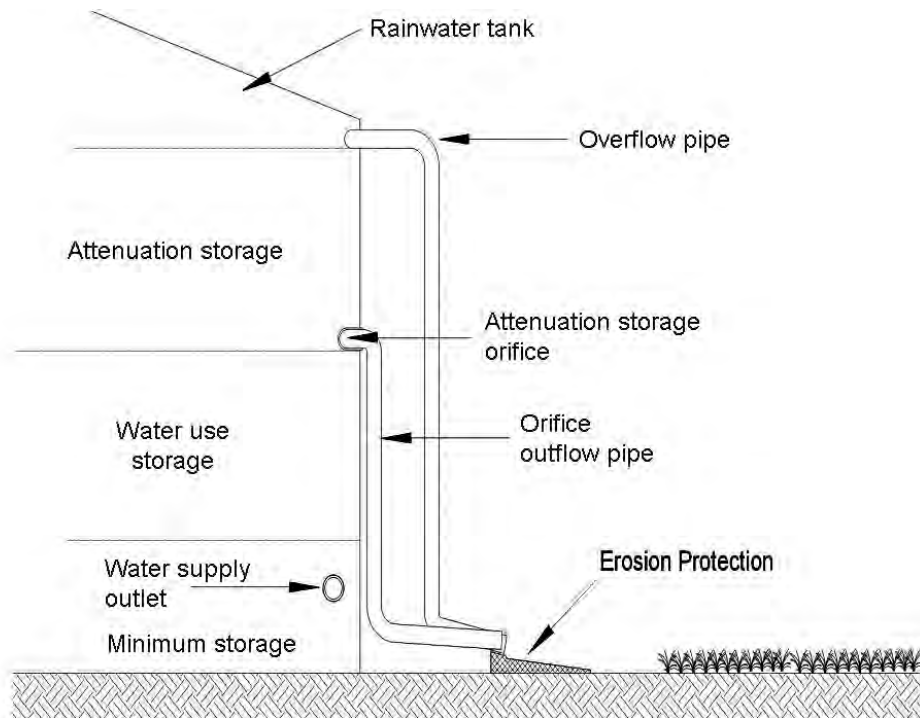

It is possible that the combined storage would provide more benefit than is estimated. A higher level of attenuation may be achieved in some instances when the tank water level is lower than the orifice level at the start of the storm. These benefits are very difficult to estimate and are not taken into account in design.

There will be a portion of the year when roof run-off will exceed water use and run-off during that time needs to be considered in terms of attenuation.

Normally, detention volumes would be determined by the difference in volumes of the pre-and post-development two or ten-year storms. Due to the similar rainfalls between the water quality storm and the two-year one-hour rainfall, the volumes for detention tank storage are provided in Figure 9.34. This detention volume is in addition to the domestic use volume.

Figure 9.34 – Water tank detention figure

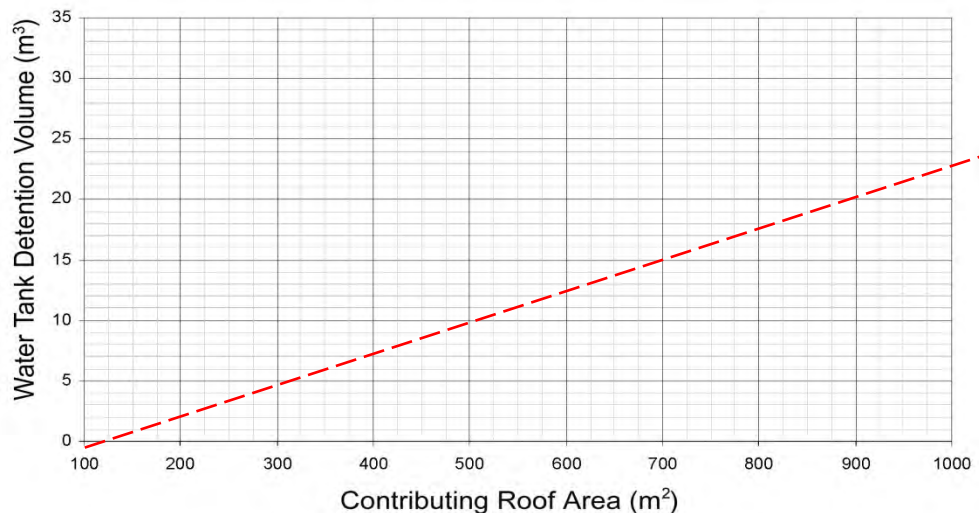

The required orifice size is a function of the storage volume and the depth of water above the orifice. This depends on the tank size selected to accommodate the water use and attenuation volume. The tank diameter, in conjunction with the attenuation volume to be stored will provide the depth of water number. This number will then be used with an orifice equation ($Q = 0.62A(2gh)^{0.5}$). Take the total detention volume and convert it to m^3/s to determine the discharge from the tank and that discharge should discharge over a 24-hour period. Where the calculation shows an extended detention orifice as being less than 10 mm, use 10 mm as the orifice size.

The design approach is to determine the Q_{10} for the predevelopment condition and design the orifice size based on the depth of attenuation storage in the tank and the limitation on peak discharge.

Commercial and industrial sites will have more concern over the percentage of rainfall that becomes run-off than residential development. The percentage of time that rainfall becomes run-off needs to be calculated using daily water use, roof area and tank size. Roof areas above $500 m^2$ need to be considered individually and a water budget established.

In those situations, attenuation of run-off may be required due to a possible larger expanse of roof area in conjunction with smaller water use.

As detailed in Figure 9.33, the water tank has three outlets:

- Water supply outlet for site water use;
- An outlet for the attenuation storage; and
- An overflow pipe for those flows that exceed the tank storage.

The water supply outlet is a standard hose connection to a pump or outlet depending on gravity feed to the water use. The outlet from the attenuation storage provides a controlled release for larger storms to reduce downstream stormwater flow increases and the overflow pipe is for all storms to flow when the tank is full of water.

Determining detention volumes and sizing outlets

The volume of storage needed for detention purposes can be addressed with one storage volume, as the volumes needed for the two and ten-year storms are very similar. The only difference would relate to the size of the outlet orifice. The tank elevations can be calculated once the attenuation storage and orifice size have been determined per the following.

- 1 Select a tank size based on site water needs and needed attenuation storage.
- 2 Set the water supply outlet at least 200 mm above the tank bottom to allow for debris settlement.

Water tanks in a residential neighbourhood



- 3 Total volumes needed for attenuation and site use are added together. These volumes then must be added to the minimum storage level (volume of tank/height of tank x 200 mm) to ensure that the tank is large enough to accommodate the three storages.
- 4 Determine the elevations of the various storages. Minimum storage level = 200 mm. Site water use = height of tank/volume of tank x site water use volume = height of water use elevation. This must be added to 200 mm to get elevation in tank of attenuation orifice invert.
- 5 Calculate invert height of overflow pipe. Overflow invert height = height of tank/volume of tank x attenuation storage volume = height of overflow pipe invert elevation. This must be added to the site water use orifice invert elevation to get the correct overflow elevation.

9.5.19 Case study

A water tank is proposed for a home in Thornton. The architects design plans show that the home has a roof area of 250 m² and it is being designed for a daily water use of 500 l/d as the tank is the sole supply for domestic water.

Design steps

- 1 With the roof area being 250 m² and a water use of 500 litres/day, calculate the amount of water that can be used where the annual rainfall is 1,294 mm. With one m² of roof area providing one litre of water, the total amount of water available is 323,500 litres minus a 15% wastage factor. So annual amount of rainfall that can be used for water supply is 274,975 litres.
- 2 Daily water consumption is 500 litres/day or 182,500 litres per annum. This indicates that the non-potable usage can be supplied by the water tank with no need for periodic top ups.
- 3 At a usage rate of 500 litres/day, the minimum tank size has to accommodate at least 3,000 litres for dry periods (500 litres x 6 days). As the water tank is used as the sole supply of domestic water the minimum tank size is 25,000 litres. It is recommended that the water tank be sized to hold at least 5,000 litres for domestic storage to account for times where large storm capture can augment supply.
- 4 Regarding detention, Figure 9.34 provides detention storage requirements for various roof areas. In terms of two and one-year storage, the tank needs to have 6.5 m³ of storage for detention purposes.
- 5 Adding the two volumes together gives a total tank volume of 11.5 m³. In addition there needs to be 200 mm of water at the bottom of the tank to accumulate organic matter that enters the tank. The height can convert to volume once a tank is selected.
- 6 For this case study, a 25,000 litre tank is selected with a diameter of 3.58 m and a height of 2.93 m.
- 7 Water supply level 200 mm high (mains augmentation, governed by a ballcock. Storage below minimum level = (25,000/2,930) x 200 = 1,706 l.
- 8 Total volumes needed are 5,000 l + 6,500 l + 1,706 l = 13,206 l. So the tank is large enough to hold the various volumes.
- 9 Height of long-term storage = 2,930/25,000 = 0.117 mm/l.
- 10 Depth of domestic use storage = 5,000 x 0.117 = 585 mm + 200 mm of dead storage = 785 mm from bottom of tank.

- 11 Depth of detention storage = $6,500 \times 0.117 = 760 \text{ mm} = 760 + 785 = 1,545 \text{ mm}$ from tank bottom.
- 12 Extended detention orifice sizing – Using orifice equation with a release rate of 0.08 l/s ($6,500/86,400 \text{ s}$), the orifice size is 2.8 mm , so use a minimum orifice size of 10 mm .

A schematic of the water tank with elevations and storage volumes is shown in Figures 9.35 and 9.36.

Figure 9.35 - Water tank schematic showing case study elevations and volumes

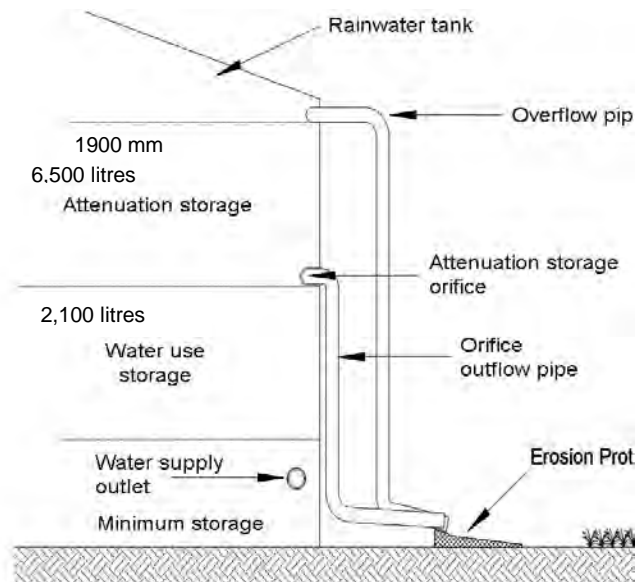
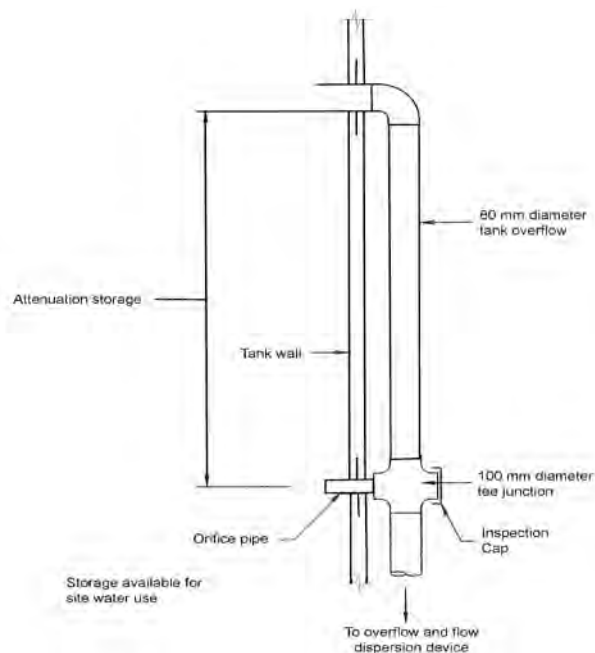

Figure 9.36 - Orifice and Exterior Pipe Details



Notes

- 1 For orifice pipe diameter and attenuation storage head use Tables C16 and C17
- 2 Maximum orifice pipe length is 150 mm . Allow 75 mm clearance from end of pipe to outside of tank wall
- 3 Fix orifice pipe to 100 mm diameter tee junction using reducer fittings

9.5.20 Bush revegetation

Description: Bush revegetation reduces site run-off by providing leaf canopy interception, evapotranspiration and soakage into the organic ground cover:

- Evapotranspiration
- Soakage
- Flow retardance



Relating to land use, stormwater run-off is greatest from impervious surfaces. Less run-off is generated from pasturelands. Native bush that is protected from grazing and having litter and brush covering the ground generates the least amount of stormwater run-off.

When land is being converted from rural to residential, commercial or industrial land use the total volume and peak rate of stormwater run-off are increased.

Stormwater Management Function



Water quality

Metals
 Sediment



Flood protection



Stream channel erosion protection

As pastureland has a greater volume of stormwater run-off than does bush, conversion of existing pastureland into bush can reduce future run-off and mitigate for the effects of increased impervious surface generation.

Design considerations

The approach is based on extent of area that is set aside for re-establishment of bush. Key considerations related to re-establishment are the following:

- Existing areas of bush that can be extended;
- Natural site features;
- Slope; and
- Location of waterways.

Providing additional bush to existing bush areas would increase the value of existing bush by increasing bush interior areas. This would reduce fringe vegetation that could become a weed maintenance problem.

When sizing bush restoration for various lot sizes, the level of imperviousness will be very important. As lot size reduces from 1 ha to 2,000 m², the proportion of the site that is impervious will increase the required bush area. Under an assumption of a 1 ha lot having 600 m² of imperviousness; it will take 3,500 m² of bush to compensate for that impervious surface. If a lot is 0.5 ha and the imperviousness of the lot remains at 600 m² the amount of bush to compensate for the impervious surface is still 3,500 m² but that will represent approximately 70% of the site area rather than 35%.

If the site area goes below 0.5 ha bush cannot compensate for 600 m² of imperviousness.

The approach can be used on a subdivision or catchment wide basis, where area can be set aside, converted to bush and overall subdivision or catchment stormwater run-off reduced. It is not only an individual site practice. Revegetation does not have to totally mitigate for impervious surfaces but it can reduce stormwater run-off increases and reduce the amount of work that other practices have to accomplish to minimise adverse impacts.

Targeted contaminants

While native bush vegetation having a good ground cover can provide contaminant reduction benefits, its main purpose is the reduction of stormwater run-off volumes. Organic matter on the bush floor will remove metals and assist in removal of sediments but residential land use in rural areas does not generate large contaminant loads. Commercial and industrial land use may increase contaminant loads but other practices provided in the guidelines would provide greater levels of treatment.

Advantages

Native bush grows over time and maintenance concerns diminish. Where other stormwater management practices need maintenance to ensure long-term performance, bush revegetation improves its hydrological function over time and maintenance obligations become minimal.

Native bush also provides benefits for wildlife habitat, shading and cooling during summer. It can act as a windbreak and can be an aesthetic amenity.

Limitations

Native bush planting can have fairly high maintenance needs during the first two to three years of growth relating to weed control and possible watering needs during drought conditions.

Native bush can also be seen as limiting site usage. If some livestock were a desired activity on the site, they must be excluded from access to the bush areas to ensure that bush growth is not adversely affected.

When planted in widths of less than 20 m, weeding can remain a problem for years.

Design sizing

Bush re-establishment is based on the following table 9.18.

Table 9.18 *Bush planting requirements.*

Proposed site impervious area (m ²)	Area of bush required (m ²)
100	1,000
200	1,500
300	2,000
400	2,500
500	3,000
600	3,500

The calculations, using an annual run-off spread sheet approach that calculates storm and base flow under various land use scenarios (Beca Carter Hollings & Ferner, 2000), work out to be fairly consistent. For every 100 m² of imperviousness beyond the first 100 m² of imperviousness there is a 500 m² requirement for bush establishment.

Recognising the significant areal extent of bush replacement, it may be best to isolate various impervious surfaces and address them separately. That would allow for several practices to provide site management without using too much of a given portion of the site to any one practice.

Case study

A house on 1 ha is being constructed and the footprint for the house and driveway is 550 m² of imperviousness. The site, as shown in Figure 9.37, has a house, driveway, septic system and needs 3,250 m² to compensate for impervious surfaces.

Since the roof of the house has a water tank that was designed as in the water tank design section then the 250 m² can be excluded from the bush revegetation approach. In that case, the impervious surface is now 290 m² so the bush replacement area is now 1,950 m², which is a significantly reduced area.

Using practices in conjunction with one another can significantly reduce the size of a practice if it is used to address all of the areas.

Figure 9.37 - Bush revegetation for run-off control

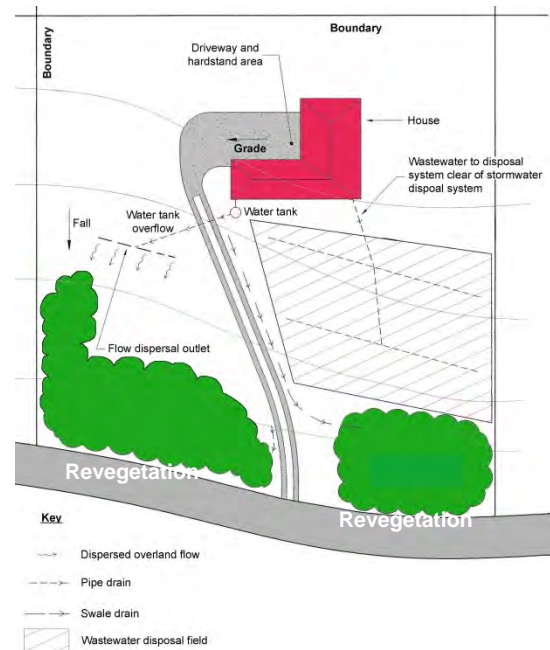

9.5.21 Oil/water separators

Description: Oil and water separators are designed and constructed to capture and treat stormwater run-off through:

- Specific gravity separation
- Surface area increases
- Sedimentation (limited)

Oil/water separator devices are applicable for treating stormwater run-off from areas where hydrocarbon products are handled or where hydrocarbon loads can be very high. They should be located as close to the source of the hydrocarbons as possible to retain the oil in a floatable, non-emulsified form.

Oil/water separators are not usually applicable for general urban stormwater run-off treatment as the oil is often emulsified or has coated sediments and is too difficult to separate. For stormwater run-off, oil/water separators would primarily be applicable in areas where there is a very high hydrocarbon load and the oil/water separator would be used in conjunction with another practice to function as part of a treatment train.

Emulsification occurs when two liquids that normally do not mix do so either through a turbulent environment or through the use of an emulsifying agent. In the case of oil/water separators, the turbulence of stormwater flows can cause the mixing of oil and water. It is important that catchment areas draining to oil/water separators be as small as possible to reduce the potential for emulsification to occur. If that happens, the effectiveness of oil/water separators will reduce significantly.

In areas where there is significant potential for accidental spills, oil/water separators may be applicable if the material having spill potential has a specific gravity less than water. From a sedimentation standpoint, oil/water separators will capture sand or grit particles but smaller sediments will either pass directly through the system or may be re-suspended in subsequent storms.

There are a number of different products that are available for use as oil/water separators. This discusses the one most commonly used: the API (American Petroleum Institute) separators. The other available products should be designed according to their manufacturers' recommendations.

API separators use baffles to ensure that oil droplets rise above the outlet openings so the oil is trapped in several different compartments. A cross section of an API separator is shown in Figure 9.38.



Stormwater Management Function

	Water quality	
<input checked="" type="checkbox"/>	<u>x</u>	Metals
	<u>x</u>	Sediment
	<u>✓</u>	TPH
<input type="checkbox"/>		Flood protection
<input type="checkbox"/>		Stream channel erosion protection

Figure 9.38 - API separator schematic

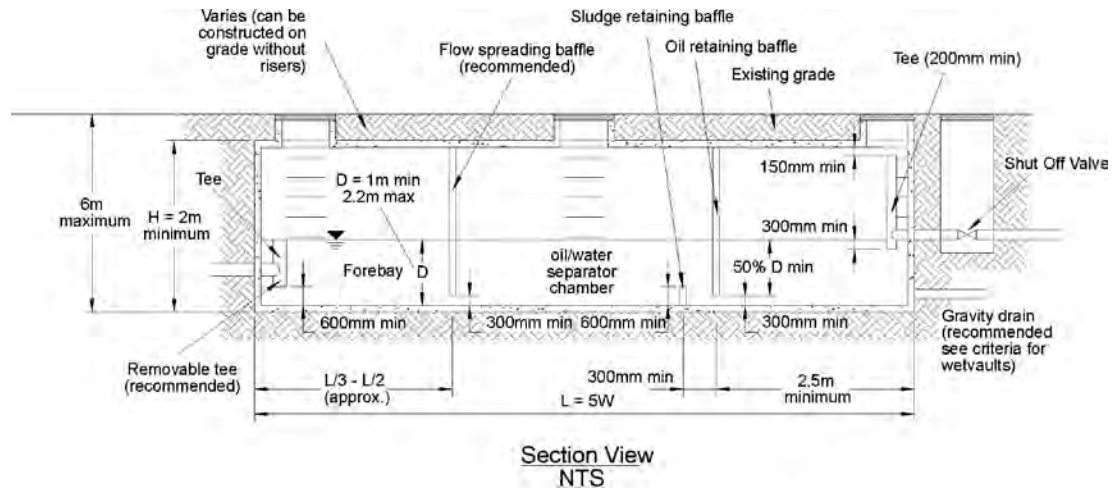

The API is discussed in good detail in the MfE Guidelines (1998).

Basic design parameters

Oil and water separators can be designed to remove oil and TPH down to 15 mg/l. Their performance depends on a systematic, regular maintenance programme. Without that programme, oil and water separators may not achieve oil and TPH removal to the required level.

In light of overseas experience that oil and water separators used for stormwater treatment have not performed to expectations, proper application, design, proper construction and operation and maintenance are essential. Other treatment systems, such as sand filters or other emerging technologies should be considered for removal of insoluble oil and TPH.

The following general design criteria should be followed:

- If practicable, determine oil/grease and TSS concentrations, lowest temperature, pH, and empirical oil rise rates in the run-off, and the viscosity and specific gravity of the oil. Also determine whether the oil is emulsified or dissolved. Do not use oil and water separators for the removal of dissolved or emulsified oils such as coolants, soluble lubricants, glycols and alcohols.
- Locate the separator off-line and bypass flows in excess of the water quality storm flow rate.
- Use only impervious conveyances for oil contaminated stormwater.
- Oil and water separators are not accepted for general stormwater treatment of TSS.

Design procedure

This design procedure is that provided by MfE guidelines (MfE, 1998). They are provided here to provide design criteria in one document, as opposed to having to search around for design procedures.

Oil-water separation theory is based on the rise rate of the oil globules (vertical velocity) and its relationship to the surface-loading rate of the separator. The rise rate is the velocity at which oil particles move toward the separator surface as a result of the differential density of the oil and the aqueous phase of the wastewater. The surface-loading rate is the ratio of the flow rate to the separator to the surface area of the separator. The required surface-loading rate for removal of a specified size of oil droplet can be determined from the equation for rise rate.

The following parameters are required for the design of an oil-water separator.

- Design flow (Q), which is the maximum wastewater flow. The design flow should include allowance for plant expansion and stormwater run-off, if applicable.
- Wastewater temperature. Lower temperatures are used for conservative design.
- Wastewater specific gravity (S_w).
- Wastewater absolute (dynamic) viscosity (μ). Note: Kinematic viscosity (ν) of a fluid of density (ρ) is $\nu = \mu/\rho$.
- Wastewater oil-fraction specific gravity (S_o). Higher values are used for conservative design.
- Globule size to be removed. The nominal size is 0.015 cm, although other values can be used if indicated by specific data.

The size of the conventional separators is subject to the following constraints.

$$V_H \leq 15 V_r$$

$$0.3 W \leq d \leq 0.5 W \text{ (typically } d = 0.5 W \text{)}$$

$$1.5 \text{ m} < W < 5 \text{ m}$$

$$0.75 \text{ m} < d < 2.5 \text{ m}$$

Where:

d is the depth (m); and

W is the width of the tank (m).

Some of these dimensions will not be appropriate for smaller catchments, and may be relaxed. It is necessary, however, to keep the length at least twice the width, the depth at least 0.75 m and $V_H < 15V_t$ at the design flow.

In addition, as a general rule, the specific gravity of oil = 0.9, diesel = 0.85 and petrol = 0.75. The specific gravity of water is 1.

To avoid re-entrainment of oil and degradation of performance, it is required that the maximum horizontal flow velocity in the main part of the tank be less than 25 m/hr.

It is also a requirement that the separator function for spill control. All separators should be capable of retaining at least 2,500 litres of spilled material.

Detailed design procedure

- 1 Calculate the design flow of the separator.

$$Q = .00278 \text{ CIA}$$

Where:

$$C = 1$$

$$I = 15 \text{ mm/hr (MfE guidance would indicate between 12-15 mm/hr for the region – Appendix A4.1 MfE guidelines)}$$

$$A = \text{Catchment area}$$

- 2 Size the separator (60 micometre oil droplet size).

Calculate the rise velocity (V_t) based on a 60 μm oil droplet of specific gravity of (s).

$$V_t = gd^2(1-s)/18\nu$$

Where:

$$V_t = \text{Rise velocity (m/s)}$$

$$g = \text{Acceleration due to gravity (9.81 m/s}^2\text{)}$$

$$d = \text{Diameter of the oil droplet (m)}$$

$$S = \text{Specific gravity for the oil droplet}$$

$$\nu = \text{Kinematic viscosity of water (m}^2\text{/s)}$$

- 3 Once the rise velocity is obtained, the through velocity is calculated.

$$V_H \leq 15 V_t$$

- 4 Having the through velocity, the cross-sectional area of the separator can be obtained.

$$A_{\text{cross-sectional}} = Q/V_H$$

$$\text{Cross-sectional area} = \text{width} \times \text{width}/2$$

- 5 The minimum width and depth requirements will determine the area. Minimum depth = 0.75 m, minimum width = 1.5 m. If the calculated cross-sectional area is less than 1.125 m^2 then.

$$V_H = Q/1.125$$

- 6 Calculate the surface area.

$$A_H = FQ/V_t$$

The F factor accounts for short circuiting and turbulence in the tank which degrades the tank performance. F is determined by the ratio of V_H to V_t .

Table 9.19 provides values of F related to horizontal and rise velocities.

Table 9.19 Turbulence factor determination.

V_H/V_t	Turbulence factor (F_t)	$F = 1.2F_t$
3	1.07	1.28
6	1.14	1.37
10	1.27	1.52
15	1.37	1.64
20	1.45	1.74

- 7 Once A_H is obtained, the length of the separator can be obtained.
 $L = A_H/w$ where w = width of separator
- 8 The volume and area determined from this tank sizing refer to the dimensions of the main compartment of the tank. Additional volume should be allowed for inlet and outlet sections in the tank.

Case study

A petrol station forecourt has a catchment area of 166 m² draining to the device.

- 1 The separator design flow is the flow from 15 mm/hr of rain, which, from the equation provided earlier, is.

$$\begin{aligned}
 Q_d &= .00278 \text{ CIA} \\
 &= .00278(1)(.0166)(15) \\
 &= 0.000692 \text{ m}^3/\text{s} \\
 &= 2.49 \text{ m}^3/\text{hr}
 \end{aligned}$$

- 2 Size the separator (60 micometre oil droplet size)

Calculate the rise velocity (V_t) based on a 60 μm oil droplet of specific gravity of (s).

$$V_t = gd^2(1-s)/18\nu$$

Where:

$$\begin{aligned}
 V_t &= \text{Rise velocity (m/s)} \\
 g &= \text{Acceleration due to gravity (9.81 m/s}^2\text{)} \\
 d &= \text{Diameter of the oil droplet (m) = .00006} \\
 S &= \text{Specific gravity for the oil droplet = 0.83} \\
 \nu &= \text{Kinematic viscosity of water (m}^2/\text{s) = at } 9^\circ = .00000138 \\
 V_t &= 0.869 \text{ m/hr}
 \end{aligned}$$

- 3 Once the rise velocity is obtained, the through velocity is calculated.

$$V_H \leq 15 V_t = 15(.869) = 13.04 \text{ m/hr}$$

- 4 Having the through velocity, the cross-sectional area of the separator can be obtained.

$$A_{\text{cross-sectional}} = Q/V_H = 0.191 \text{ m}^2$$

$$\text{Cross-sectional area} = \text{width} \times \text{width}/2$$

- 5 The minimum width and depth requirements will determine the area. Minimum depth = 0.75 m, minimum width = 1.5 m. If the calculated cross-sectional area is less than 1.125 m² then.

$$V_H = Q/1.125 = 2.21 \text{ m/hr}$$

- 6 Calculate the surface area.

$$A_H = FQ/V_t$$

The F factor accounts for short circuiting and turbulence in the tank which degrades the tank performance. F is determined by the ratio of V_H to V_t .

Table 9.19 (repeated) provides values of F related to horizontal and rise velocities.

Table 9.19 Turbulence factor determination.

V_H/V_t	Turbulence factor (F_t)	$F = 1.2F_t$
3	1.07	1.28
6	1.14	1.37
10	1.27	1.52
15	1.37	1.64
20	1.45	1.74

$V_H/V_t = 2.55$ so interpolating below 3 gives an F of 1.26

$$A_H = 3.61 \text{ m}^2$$

Once A_H is obtained, the length of the separator can be obtained.

$$L = A_H/w \text{ where } w = \text{width of separator} = 3.61/1.5 = 2.41 \text{ m}$$

The volume and area determined from this tank sizing refer to the dimensions of the main compartment of the tank. Additional volume should be allowed for inlet and outlet sections in the tank. Additional length at the exit is 0.6 m so overall length is 3.01 m.

9.6 Bibliography

State of New Jersey, Best Management Practices Manual, February 2004.

Municipality of Metropolitan Seattle, Biofiltration Swale Performance, Recommendations, and Design Considerations, Water Pollution Control Department, Publication 657, October 1992.

Washington State Department of Ecology, Stormwater Management Manual for Western Washington, Volume 1 - Minimum technical Requirements for Site Planning, Publication Numbers 99-11 through 99-13, August 2001.

California Stormwater Quality Association, California Stormwater BMP Handbook, New Development and Redevelopment, January 2003.

- Larcombe, Michael, Removal of Stormwater Contaminants Using Grass Swales, prepared for the Auckland Regional Council, January 2003.
- Chow, Ven Te, Open Channel Hydraulics, McGraw-Hill Book Company, Inc., 1959.
- Washington State Department of Transportation (WSDOT). 1995. Highway Run-off Manual. Washington State Department of Transportation.
- Christchurch City Council, Waterways, Wetlands and Drainage Guide, Part B: Design, 2003.
- Auckland Regional Council, Guidelines for Stormwater Run-off Modelling in the Auckland Region, Technical Publication No. 108, April 1999.
- Somes, N., Crosby, J., Review of Street Scale WSUD in Melbourne Study Findings, Kingston City Council and the Better Bays and Waterways, 13/1/01 (It is believed that the date is a typographical error as an earlier revision was dated 2007), the date is probably 13.1.08.
- Facility for Advancing Water Biofiltration, fawb-day1-performance, a PowerPoint presentation available on the internet, 5 July 2008.
- Facility for Advancing Water Biofiltration, Guidelines for Soil Media in Bioretention Systems, Version 2.01, March 2008.
- NZWERF, On-Site Stormwater Management Guidelines, October 2004.
- Davis, ROE, Bennett, H., H., Grouping of Soils on the Basis of Mechanical Analysis, United States Department of Agriculture, Departmental Circulation No. 419, 1927.
- Wong, T., H., F., Breen, P., F., Somes, N., L., G., and Lloyd, S., D., Managing Urban Stormwater Using Constructed Wetlands, Cooperative Research Centre for Catchment Hydrology, and Department of Civil Engineering, Monash University, Cooperative Research Centre for Freshwater Ecology and Melbourne Water Corporation, 2nd edition, September 1999.
- Mitchell, C., Pollutant Removal Mechanisms in Artificial Wetlands, Course notes for the IWES 1996 International Winter Environmental School, Gold Coast, July 1996.
- Cappiella, K., Fraley-McNeal, L., Novotney, M., Schueler, T., The Next Generation of Stormwater Wetlands, Wetlands & Watersheds Article #5, Prepared for Office of Wetlands, Oceans and Watersheds, U.S. EPA, February 2008.
- Wong, T., Breen, P., F., Somes, N., L., G., Lloyd, S., D., Managing Urban Stormwater Using Constructed Wetlands, Industry Report, Report 98/7, Second Edition, Cooperative Research Centre for Catchment Hydrology and Department of Civil Engineering of Monash University, Cooperative Research Centre for Freshwater Ecology and Melbourne Water Corporation, September 1999.
- North Shore City Council, Raintank Guidelines, First Edition, July 2008.
- Ministry for the Environment, Environmental Guidelines for Water Discharges from Petroleum Industry Sites in New Zealand, prepared for a Joint Working Group of the Ministry for the Environment, local authorities and petroleum marketing companies, December 1998.
- Auckland Regional Council, Stormwater Management Devices: Design Guidelines Manual, Second Edition, May 2003.

Part 10: Innovative practices

10.1 Introduction

As the Stormwater Programme continues to mature, alternative technologies will be proposed to meet water quality design goals. These innovative practices may be developed where site or catchment development intensity make it difficult to achieve desired water quality treatment levels with conventional systems, or provide a level of treatment that is not possible with conventional approaches.

BOPRC, through the consent process encourages the development of innovative, cost-effective stormwater management technologies, subject to approval. Approval will depend on submission of objective, verifiable data that supports the claimed efficiency, although a single pilot site may be approved for purposes of data collection to document performance.

Innovative practices tend to be new technologies that have not been evaluated using approved protocols, but for which preliminary data indicate that they may provide a desirable level of stormwater contaminant control. Some innovative practices have already been installed or are proposed in the region as parts of treatment trains or as a stand-alone practice for a specific project. In some cases, innovative practices may be necessary to remove metals or hydrocarbons. Innovative practices can also be used for retrofits and where land availability does not permit larger conventional practices.

10.2 Objective

This part outlines the information that should be submitted to evaluate the performance of alternative technologies whose operating parameters have not yet been verified to the satisfaction of BOPRC.

This section deals with stand-alone and pre-treatment/retrofit practices.

10.2.1 Stand-alone practice

An innovative practice should not be used for new development sites unless there are data indicating that its performance is expected to be reasonably equivalent to that provided by conventional practices, or as part of a treatment train. In retrofit situations, the use of any practices that make substantial progress toward the specified environmental objectives is encouraged.

Any alternative stand-alone practice must generally comply with BOPRC water quality recommendations.

Specific contaminant issues may warrant use of an alternative system that may be less effective at TSS reduction while providing enhanced reduction in other contaminants such as hydrocarbons or nutrients. Performance at specific contaminant reduction will be monitored appropriately.

Water quantity issues may also affect practice acceptance, depending on location in a catchment.

10.2.2 Pre-treatment or retrofit

Individual practices that are not capable of providing desired water quality treatment may nevertheless play a useful pre-treatment supplementary role together with other approved stand-alone practices.

A practice proposed for pre-treatment of flows into another practice may, for example:

- Remove coarse sediments, in order to reduce the frequency of maintenance of the primary stormwater treatment practice;
- Provide water quantity control; and
- Reduce stream erosion.

Retrofit of a site or catchment for water quality treatment depends on land availability, specific contaminants of concern and cost. Water quality goals must be tempered by what can realistically be accomplished in a catchment. It is in these situations where innovative practices have a potentially significant role to play.

10.3 General information required from an applicant for approval of innovative systems

Innovative systems are being introduced on a routine basis. Current ones include:

- Storm drain inserts;
- Underground vaults;
- Filter media flow through systems;
- Hydrodynamic structures; and
- On-line storage in the storm drain network.

This subsection summarises the basic information that should be submitted with any request for approval in a specific application in order to promote consistency in the submission of information for approval of an innovative practice. Consistency provides surety for a product manufacturer, a consent applicant and the general public that implementation of an innovative practice is based on the best information available. The ultimate goal is clean water and implementation should be based on an estimation of the best practice being used in a given situation.

It is important to be cautious with using innovative technologies for new development and retrofits. Before selecting an innovative practice for a limited application, available information should be evaluated using an acceptable protocol.

For these reasons, submission of an innovative practice in a given situation or for general compliance should include a description of the innovative technology or product including:

- Whether the operating parameters of the system have been verified;
- Existing or proposed monitoring data (detailed in Section 10.4);
- Documentation of processes by which TSS and other contaminants will be reduced (physical, chemical, biological);
- Documentation and/or discussion of potential causes of poor performance or failure of the practice;

- Key design specifications or considerations;
- Specific installation requirements;
- Specific maintenance requirements;
- Data to support the claimed TSS removal efficiency. If the technology is new or the existing data is not considered reliable, a detailed monitoring programme to assess the TSS removal may be required; and
- Ownership issues that could influence use of innovative practices on individual sites. Examples of this issue could be refusal of a TA to accept responsibility for operation and maintenance.

10.4 **Information needed to judge adequacy of existing or proposed monitoring data**

The following summarises the detailed information that is needed to properly judge the adequacy of existing or proposed monitoring data to evaluate performance compliance of an innovative practice, from catchment related information, practice related information and water quality information.

10.4.1 **Catchment parameters**

The context in which the practice operates helps define situations where an innovative practice is (or is not) appropriate by assessing collection sites for known or new data. This in turn helps to determine the data's applicability to other locations.

It is also important that monitoring be done in the field, as opposed to the laboratory, as field monitoring better reflects actual practice performance.

Key catchment parameters include:

- Catchment area served;
- Percentage impervious area;
- Total impervious area;
- Hydraulic connectivity;
- Baseflow or storm generated run-off only; and
- Catchment land use and expected contaminants.

10.4.2 **Practice design parameters (where applicable)**

Detailing specific elements of the innovative practice provides a clear understanding of the water quality treatment processes that occur in the various components of the practice. If the practice has a standard design that is based on catchment size or maximum flow rate, that information should be clearly stated in the discussion of practice parameters as detailed in the general discussion.

Key practice parameters include:

- Basic shape (length/width, volume, importance of local topography);
- Any permanent pool elevation and levels of service;
- Surcharge elevation;

- Forebay characteristics;
- Inlet/outlet locations and relative elevations;
- Water level control options;
- 'On-line' or 'off-line';
- Age of practice where monitoring has been or will be done; and
- Specifications for practice components (filter media, sieve sizes, geotextile specifications, etc.).

10.4.3 Water quality analysis

Analyses detailed here are primarily for those done in New Zealand. Recognising that many innovative practices are being developed overseas, all information may not be available. In those situations a degree of judgement is involved regarding the relative importance of specified criteria. BOPRC will consider the submission of overseas data as full or partial fulfilment of the water quality analyses, depending on the applicability of the collected data to the Bay of Plenty situation. Compliance assurance may necessitate water quality analyses on a limited basis only for those parameters where gaps exist.

The following analyses are to be done for practice performance documentation:

- Flow weighted composite samples used to determine the TSS concentrations in the influent and effluent of the device;
- General water quality constituents for monitoring include TSS, pH, conductivity, DO, enterococci and total hydrocarbons;
- Total zinc should also be monitored as a 'keystone' contaminant for trace metals;
- For practices claiming nutrient removal benefits, monitoring of TN and TP;
- The performance of the practice or system should be based on the sampling results from at least ten storms representative of those normally occurring in the Region. Depending on the relative variation in results, additional monitoring may be necessary to better understand expected performance;
- At least one storm event must be greater than 20 mm of rainfall;
- There must be at least three days of dry weather between storms sampled;
- The samples must be collected and handled according to established procedures that are included in the monitoring plan;
- The laboratory selected for analysis of the samples is recognised as technically proficient;
- The efficiency of the device is calculated for individual events and is also based on the total TSS load removed for all monitored events;
- The monitoring must be conducted in the field as opposed to laboratory testing; and
- Depending on the processes involved in treatment, the practice or system may need to be in the ground for at least six months at the time of monitoring.

10.5 Discussion

While the level of information requested may seem onerous to someone developing or wanting to use an innovative practice, it is essential that programme implementation and overall success be underpinned by good technology. With millions of dollars being spent on design, implementation and operation, it is important that environmental objectives are met, especially when considering the costs associated with management.

Ultimate programme success rests on stormwater strategies, approaches and practices achieving a certain level of performance. We must have confidence that a practice will achieve stated goals and a good understanding of practice strength, limitations, and performance if we are to meet our obligations under the RMA and public expectations.

Part 11: Landscaping

11.1 Introduction

Landscaping is critical to improving both the function and appearance of stormwater management practices. It has aesthetic, ecological and economic value that is often not recognised during site design and construction. In almost all cases, compliance with regulatory requirements is the key driver and the issue of how a stormwater practice fits into the local landscape can be overlooked.

Moreover, where the initial developer is not the eventual property owner, there may not be a long-term interest in landscaping.

Where the local territorial authority assumes the maintenance responsibility for the practice and/or becomes the owner of the practice, landscaping issues must become a standard asset management cost in the Council's financial plans.

If the practice is considered an eyesore, property values will go down and the general public response to stormwater management will be negative. The stormwater practice must be an integral part of the development and given the same landscape attention as other parts of the site.

Example of a stormwater pond that has little aesthetic value



11.2 Objective

The objectives of landscaping stormwater management practices are to:

- Improve their aesthetics;
- Improve their water quality and ecological function; and
- Increase the economic value of the site.

A good landscape plan will consider all three objectives. This means involving a professional landscape architect with experience in natural system design.

Considerations include:

- Site soils;
- Slopes;
- Hydrologic conditions; and
- Water quality/ecological benefits.

The following discussion expands on the three objectives.

11.2.1 Improve the aesthetic appeal of stormwater practices

Aesthetics is a subjective yet very important aspect of everyday life. It is a concept that is difficult to define quantitatively. Something that is good aesthetically tends to be considered tasteful, pleasing, appropriate and fitting for its location. Tastes differ, and disagreement about what is aesthetic is common. The goal of this section is to ensure that stormwater practices are designed as an asset to the property owner and to the overall community.

Green wall on a building in Paris



11.2.2 Improve the water quality and ecological function of the practices

Attention to landscaping as a component of a stormwater management practice can have a significant positive effect on water quality and ecological function. Shading of practices can reduce thermal impacts on receiving systems. Vegetated buffer zones (woody or grassed) can reduce sediment entry, and natural vegetation promotes local ecological diversity.

Landscaping plans should consider:

- Chemical use reduction;
- Contaminant source reduction;
- Impervious surface mitigation.

Projects should be designed to minimise the need for toxic or potentially contaminating materials such as herbicides, pesticides, and fertilisers within the stormwater management practice area.

Materials that could leach contaminants or pose a hazard to people or wildlife should not be used as components of a stormwater practice (examples can include chemically treated wood or galvanised metals).

Good landscaping can also reduce impacts of impervious surfaces by incorporating swales by paths and access ways.

11.2.3 Increase the economic value of the site

A number of studies demonstrate the economic benefits of properly landscaped stormwater systems:

- Study in Maryland in the U.S. found that properly designed stormwater management ponds increased adjacent property values by 10-15%;
- The U.S. EPA's literature review of the impacts of urban run-off ponds on property values is available on EPA's website at www.epa.gov/OWOW/NPS/run-off.html; and
- City of Christchurch has been engaged in natural stream restoration and has identified significant monetary benefit to property values for properties abutting the restored stream channels.

11.3 Use of native species

This Stormwater Management Guideline encourages the use of native plants in stormwater management practices, where they are appropriate. Native plants are defined as those species found in the Bay of Plenty region before European migration.

Native species have distinct genetic advantages over non-native species for planting. As they have evolved here naturally, indigenous plants are best suited for our local climate. This translates into greater survivorship when planted and less replacement and maintenance during the life of a stormwater management practice. Both of these attributes provide cost savings for the practice owner.

People often plant exotic species for their ornamental value. While it is important to have aesthetic stormwater management practices for public acceptance and the maintenance of property value, it is not necessary to introduce foreign species for this purpose. There are a number of native species that are aesthetically pleasing and can be used as ornaments.

11.4 General landscape guidance for all stormwater practices

There are several components of a landscape plan. They should be considered individually and together to ensure implementation of a successful landscape plan. The components include the following:

- Stormwater practice area;
- Landscape screening;
- Soils;
- Site preparation;
- Planting; and
- General guidance.

A nice water feature that provides water quality treatment while being a community amenity



11.4.1 Stormwater practice area

The practice area includes the stormwater management practice itself, maintenance access ways, fencing and a minimum buffer around these elements. The buffer ensures that adequate space is available for landscaping. Other site elements can be located within the buffer if the need arises. The landscape plan should designate the practice and buffer area.

11.4.2 Landscape screening

Practice elements can include items such as chain link fences, concrete headwalls, outfall pipes, riprap, gabions, steel grates, steep side slopes, manhole covers, and so on. These elements can be screened from general public view with plant materials. Landscape screens of shrubs and trees could have a significant beneficial effect on public perception if used effectively.

11.4.3 Soils

It is necessary to test the soil in which you are about to plant in order to determine the following:

- pH;
- Major soil nutrients;
- Minerals; and
- Seasonal wetness and water-retention capacity.

The soil samples should be analysed by a qualified professional who will explain the results and their implications for plant selection.

11.4.4 Site preparation

Construction areas are often compacted, so that seeds wash off the soil and roots have difficulty penetrating it. No material storage or heavy equipment should be allowed in the stormwater practice or buffer area after site clearing has been completed, except to excavate and grade the stormwater management area. All construction and other debris must be removed before topsoil is placed.

For planting success, soils should be loosened to a depth of approximately 150 mm. Hard clay soils will require disking to a deeper depth. The soil should be loosened regardless of the ground cover. This will improve seed contact with the soil, increase germination rates and allow the roots to penetrate the soil.

Providing good growing conditions can prevent poor vegetative cover. This saves money, as vegetation will not need to be replanted.

11.4.5 Planting

In selecting plants, consider their desired function in the landscape. Is the plant needed as ground cover, soil stabiliser or a source of shade? Will the plant be placed to frame a view, create a focus or provide an accent? Does the adjacent use provide conflicts or potential problems and require a barrier, screen, or buffer? Nearly every plant and plant location should be provided to serve some function in addition to any aesthetic appeal.

Nice example of native bush planting on a subdivision slope



Certain plant characteristics are obvious but may be overlooked in the plant selection, especially size and shape.

Tree limbs, after several years, can affect power lines. A wide-growing shrub may block an important line of sight to oncoming vehicular traffic. A small tree, when full grown, could block views. Consider how these characteristics can work today and in the future.

It is critical that selected plant materials are appropriate for soil, hydrological conditions and other practice and site conditions. More information on adequacy of specific plant species is provided in the individual practice parts.

11.4.6 General guidance

- Trees, shrubs, and any type of woody vegetation are not allowed on a dam embankment. Root penetration of the embankment could weaken it in the future.
- Check water tolerances of existing plant materials prior to inundation of area.
- Stabilise aquatic and safety benches with emergent wetland plants and wet seed mixes.
- Do not block maintenance access to structures with trees or shrubs.
- To reduce thermal warming, shade inflow and outflow channels as well as northern exposures of ponds.
- Shading of standing water reduces undesirable algae blooms.
- Avoid plantings that will require routine or intensive chemical applications.
- Test the soil to determine if there is a need for amendments.
- Use low-maintenance ground cover to absorb stormwater run-off.
- Plant stream and water buffers with trees and shrubs where possible to stabilise banks and provide shade.
- Maintain and frame desirable views. Take care not to block views at road intersections or property entrances. Screen unattractive views into the site.
- Use plants to prohibit pedestrian access to ponds or steeper slopes.

- Consider the long-term vegetation management strategy of the stormwater practice, keeping in mind the maintenance obligations of the eventual owners.
- Preserve existing bush areas to the extent possible.

11.5 Specific landscape provisions for individual stormwater management practices

In addition to the general guidance presented above, more specific guidance is given below for individual stormwater practices (this guidance is subject to variation from site to site).

11.5.1 Ponds and wetlands

Part 7 provides design guidance for ponds and wetlands. Ponds and wetlands have several defined elements that affect landscaping, including:

- Pond shape;
- Pond topography; and
- Zones of water inundation and periodic saturation.

11.5.2 Pond shape

Pond or wetland shape strongly influences public reaction. A rectangular pond is not seen as a 'natural' site feature and offers little in terms of amenity value. A pond with an irregular shoreline or one that apparently fits in with natural contours is more attractive. In addition, an irregular shape has a longer edge than a rectangular pond and allows for more planting, both above and below the water line. BOPRC recommends an irregular shoreline or one that follows existing contours. A minimum recommended buffer area around the pond is five metres above the shoreline where a reverse safety bench, as detailed in Part 9, and plantings can be established.

11.5.3 Pond topography

Topography has a major effect on the range of plants that can be grown, the movement of water through the pond or wetland and public safety. Steep side slopes can be dangerous for people slipping into a pond and will affect the types of plants that can be used.

BOPRC recommends a 300 mm deep 3 m wide level bench below the normal pool level. This is recommended for safety reasons and for growth of emergent wetland plants. The plants will act to restrict public access to deeper water.

Islands, effectively placed, can also be used for multiple benefits. They can increase stormwater flow paths, provide additional landscaped areas and provide wildlife habitat. Islands also increase edge lengths and vegetated areas.

An attractive pond and plantings as community amenities



11.5.4 Zones of water inundation and periodic saturation

Normal pond and wetland function will result in a number of zones becoming established, each providing different landscaping opportunities.

(a) Zone 1 – Periodic flooding zone

Sometimes flooded, but usually above the normal water level.

This zone is inundated by floodwaters that quickly recede in a day or less. Key landscaping objectives may be to stabilise steep slopes and establish low maintenance natural vegetation.

(b) Zone 2 – Bog zone

Apart from periods in the summer, the soil is saturated.

This encompasses the pond or wetland shoreline. The zone includes the safety bench and may also be periodically inundated if storm events are subject to extended detention. Plants may be difficult to establish in this zone, as they must be able to withstand inundation of water during storms or occasional drought during the summer. These plants assist in shoreline stabilisation and shading the shoreline, contaminant uptake and limiting human access. They also have low maintenance requirements.

(c) Zone 3 – 0-150 mm deep of normal pool depth

This is a transition zone between the bog zone and the 150-500 mm ponded depth in which the water level sometimes drops and the area becomes a bog. Plants in this area must be able to tolerate periodic (but not permanent) saturated soil conditions.

(d) Zone 4 – 150-500 mm deep

This is the main zone where wetland plants will grow in stormwater ponds and wetlands. Plants must be able to withstand constant inundation of water and enhance contaminant uptake.

Plants will stabilise the bottom and edge of the pond, absorbing wave impacts and reducing erosion. They will slow water velocities and increase sediment deposition rates along with reducing re-suspension of sediments.

A well-vegetated wetland pond



(e) Zone 5 – 500 - more than 1,000 mm deep

This zone is not generally used for planting because there are not many plants that can survive and grow in this zone.

11.5.5 Infiltration and filter practices

Infiltration and filter practices either take advantage of existing permeable soils or create a permeable medium such as sand. When properly planted, vegetation will thrive and enhance the functioning of the practices. For example, pre-treatment buffers will trap sediments. Successful plantings provide aesthetic value and wildlife habitat, making the facilities more acceptable to the general public.

Planting around infiltration or rain garden practices for a 5-10 m distance will cause sediments to settle out before entering the practice, thus reducing the frequency of maintenance clean out. As a planting consideration, areas where soil saturation may occur should be determined so that appropriate plants may be selected. Shrubs or trees must not be planted in areas where maintenance access is needed.

A road median with dispersed flow into vegetation (no kerb)



11.5.6 Swales and filter strips

Key considerations include:

- Soil characteristics;
- Plant interaction;
- Effects on stormwater treatment; and
- Riparian buffers.

The characteristics of the soil are perhaps as important as practice location, size, and treatment volume. The soil must be able to promote and sustain a robust vegetative cover.

Swale in Papamoa treating highway run-off



Plant interaction is also important. Planting woody vegetation next to a swale or filter strip may shade the swale and allow intolerant grass species to grow in it.

The landscape plan will have to consider the effects that overall landscaping will have on stormwater treatment.

Riparian buffers are an excellent example of filter strips with high ecological, water quality and aesthetic value. When appropriately designed, they can treat dispersed run-off from adjacent land. The buffer, as shown in the adjacent picture, can be an amenity to the community and increase economic value of adjacent lands.

Riparian buffer as an attractive amenity to the stream

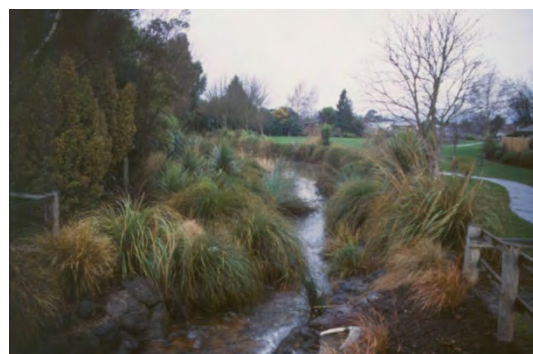

11.6 **Bibliography**

City of Portland, Stormwater Management manual, Adopted July 1, 1999, revised September 1, 2000.

Maryland Department of the Environment, 2000 Maryland Stormwater Design Manual, Volumes I & II.

Part 12: Outlet design

12.1 Introduction

Erosion at pipe or channel outlets is common. Determination of the flow condition, scour potential and channel erodibility should be a standard component of stormwater management design. The only safe procedure is to design the outfall on the basis that erosion at the outlet and downstream channel is to be expected. A reasonable procedure is to provide at least minimum protection, and then inspect the outlet channel after major storms to determine if the protection must be increased or extended. Under this approach, the initial protection against channel erosion should be sufficient to provide some assurance that extensive damage would not result from one run-off event.

Two types of erosion result from stormwater discharges:

- Local scour in the vicinity of pipe or channel outfall.
- General channel degradation further downstream.

Local scour is the result of high velocity flow at the pipe outlet. It tends to have an effect for a limited distance downstream. Natural channel velocities are almost universally less than pipe outlet velocities, because the channel cross section, including the floodplain, is generally larger than the pipe flow area while the frictional resistance of a natural channel is greater than the frictional resistance of a concrete pipe. Thus, flow eventually adjusts to a pattern controlled by the channel characteristics.

Channel degradation represents a long-term lowering of the stream channel, which may proceed in a fairly uniform manner over a long length or may be evident in one or more abrupt drops. A number of stream channels in the Region are degrading as a result of increased stormwater run-off volumes from changed land use, initially from forest to rural use and further from rural to urban use. Waterway instability considerations are an essential element of overall stormwater management design.

Outlet protection for culverts, stormwater outfalls or ditches is essential to prevent erosion from damaging downstream channels and receiving environments. Outlet protection can be a channel lining, structure or flow barrier designed to lower excessive flow velocities from pipes and culverts, prevent scour, and dissipate energy. Good outlet protection will significantly reduce erosion and sedimentation by reducing flow velocities.

Example of erosion at a pipe outfall



12.2 Objective

Outlet protection aims to protect outfall areas from local scour. It is necessary whenever discharge velocities and energies at the outlets of pipes or ditches are sufficient to erode the downstream reach.

When an outfall is sited in a coastal environment, it is essential to also consider wave energy in determining appropriate rock sizing.

12.3 Design approach

Key design elements include:

- Pipe grade.
- Outlet velocity.
- Riprap aprons.
- Engineered energy dissipaters.
- Flow alignment and outfall setback in freshwater receiving environments.
- Erosion control in coastal environments.

These are summarised below:

12.3.1 Pipe grade

To minimise the complexity of analysis and design of outlet protection structures, the first step is to look for ways to reduce the need for outlet protection by laying the pipe at as low a grade as possible, for example by using a drop structure in the pipe a short distance above the outfall.

12.3.2 Outlet velocity

The design and analysis of riprap protection, stilling basins, and other types of outlet structures can be a complex task to accomplish. The first step is to look for ways to reduce the need for outlet protection by laying the pipe at a grade no steeper than possible (possibly using a drop structure in pipe). When considering outfall velocities, there is value in considering what velocities natural channels can tolerate prior to eroding. Table 12.1 (Fortier and Scobey, 1926, same as Table 7.4) provides those values.

The primary consideration in selecting the type of outlet protection is the outlet velocity for pipes or channels, which is dependent on the flow profile associated with the design storm.

Pipe flow may be controlled by:

- The type of inlet;
- The throat section;
- The pipe capacity; or
- The type of outlet.

The type of control may change from outlet control to inlet control depending on the flow value

Table 12.1 Maximum Permissible Velocities (Fortier and Scobey (1926)).

Material	Velocity (m/s)
Fine sand (colloidal)	0.46
Sandy loam (non-colloidal)	0.53
Silt loam (non-colloidal)	0.61
Alluvial silt (non-colloidal)	0.61
Ordinary firm loam	0.76
Volcanic ash	0.76
Fine gravel	0.76
Stiff clay	1.14
Graded loam to cobbles (non-colloidal)	1.14
Alluvial silt (colloidal)	1.14
Graded silt to cobbles (colloidal)	1.22
Coarse gravel (non-colloidal)	1.22
Cobbles and shingles	1.52
Shales and hard pans	1.83

For inlet control, the outlet velocity is assumed to be normal depth as calculated by Manning's equation.

For outlet control, the outlet velocity is found by calculating the channel flow from Manning's equation with the calculated tailwater depth or the critical flow depth of pipe, whichever is greater.

12.3.3 Riprap aprons

Outlet protection can take the form of riprap placement with the stone sizing being done as part of the storm drainage design, and using these guidelines. Riprap outlet protection is usually less expensive and easier to install than concrete aprons or energy dissipaters. A riprap channel lining is flexible and adjusts to settlement; it also serves to trap sediment and reduce flow velocities.

Riprap aprons should not be used to change the direction of outlet flow: an impact energy dissipater is more appropriate for this. Riprap aprons aim to manage the transition of piped stormwater into a stream channel primarily by their higher Manning's roughness coefficient, which slows the water velocity.

Riprap aprons should be constructed, where possible, at zero percent grades for the specified length.

Grouted riprap may be subject to upheaval from periodic saturation of clay subgrades and is therefore not generally recommended for outlet velocity protection. Upheaval can crack the grout resulting in undersized riprap size for the velocities of flow. In general ungrouted, properly sized riprap provides better assurance of long-term performance.

Laying riprap directly on soils can allow the water to hit soil particles, dislodging them and causing erosion. Filter cloth laid between the soil and riprap will reduce this concern. Filter cloth is graded on the thickness and permeability characteristics. A qualitative judgement is usually made on the appropriate grade to prevent erosion and prevent puncture by riprap.

12.3.4 Engineered energy dissipaters

There are many other types of energy dissipaters. An older document is the Culvert Manual, Volume 1 done by the Ministry of Works and Development in August, 1978. There have been many types developed over the years. Commonly used varieties include stilling basins, baffle blocks within a headwall and impact energy dissipaters.

Engineered energy dissipaters including stilling basins as shown in Figure 12.1, drop pools, hydraulic jump basins or baffled aprons are required for outfalls with design velocities more than 6 m/s. These should be designed using published or commonly known techniques found in such references as *Hydraulic Design of Energy Dissipaters for Culverts and Channels, HEC 14, July 2006, Metric Version*. This design approach can be downloaded from the Internet at www.fhwa.dot.gov/bridge/hydpub.htm.

Figure 12.1 - Engineered Stilling Basin designed to trigger a hydraulic jump in combination with a tailwater condition

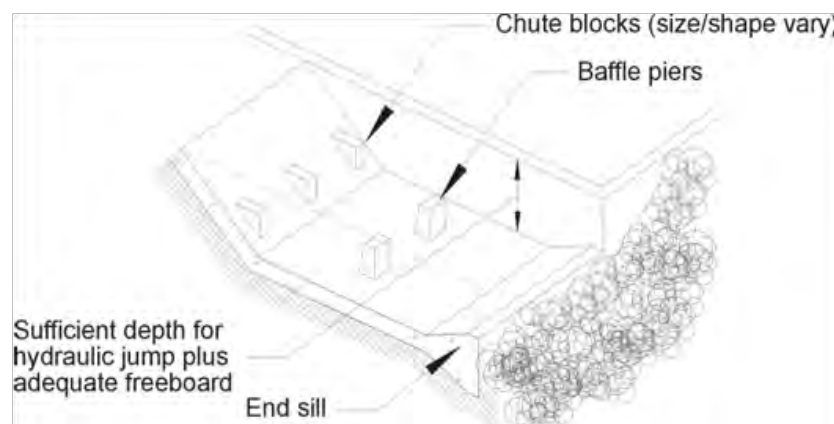

12.3.5 Flow alignment and outfall setback in freshwater receiving environments

Depending on the location and alignment of the pipe outfall and the receiving stream, outfall structures can have a significant effect on receiving channels. Alignment at a right angle to the stream will force the flow to make a 90° angle to the direction of flow. This can cause scour of the opposite stream bank as well as causing significant turbulence at the point of entry.

The preferred approach is to align the pipe flow at no more than a 45° angle to the stream.

Figure 12.2 shows an angled outfall entry to a stream.

Figure 12.2 - Angled entry of outfall into a stream

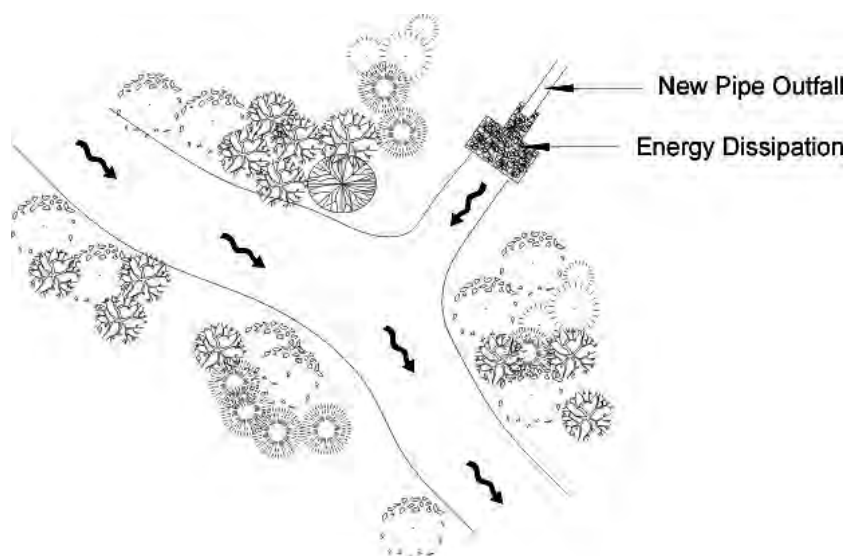

If the pipe outfall must be directly into the stream channel, riprap must be placed on the opposite stream channel boundary to a depth of 300 mm above the elevation of the pipe crown. This is in addition to a riprap apron at the pipe outfall.

The impact of new pipe outfalls can be significantly reduced on receiving streams by locating them further back from the stream edge and digging a channel from the outfall to the stream. This would allow for energy dissipation before flows enter the stream, as shown in Figure 12.2. At a minimum, the pipe outfall should be located far enough back from the stream edge to prevent the energy dissipater intruding on the channel.

12.3.6 Erosion control in coastal receiving environments

Discharges and outlet structures may give rise to a number of adverse effects on the coastal environment if they are constructed of inappropriate materials and/or are poorly sited. For example, a discharge may cause or exacerbate erosion of a beach or an outlet may detract from the natural character or amenity value of the coastal environment or impede public access to, from and along the coast.

Before locating a discharge in the Coastal Marine Area particular consideration should be given to the following matters to avoid/minimise any adverse effect on the natural character, amenity or public access values of the coastal environment:

- 1 Discharging in such a location that will not unnecessarily cause or exacerbate erosion, particularly of beach materials. For a discharge to a beach, this may involve locating the point of discharge away from the active beach system, e.g. at or near an adjacent headland.
- 2 Where there are multiple points of discharge to a beach system, consideration should be given to combining discharges to a common point of discharge, including via a common structure.
- 3 Ensuring the visual form and appearance of the outlet does not detract from its immediate surrounds and the natural character of the coastal environment, e.g. ensuring the structure is assumed into its locality rather than contrasts with that environment. The use of locally sourced rock and/or coloured and sculpted concrete forms may be appropriate.

- 4 Keeping the “footprint” of the structure to a minimum.
- 5 Incorporating the discharge pipe into another structure, e.g. a boat ramp, to minimise the number of structures in the coastal environment.
- 6 Locating the outlet and discharge in such a position as to not create an obstacle to public access to, from or along the Coastal Marine Area.

12.4 Detailed design

The design of outlet protection can be done in two ways. The most accurate approach is that in *Hydraulic Design of Energy Dissipators for Culverts and Channels, HEC 14, July 2006, Metric Version*. This is widely used by design professionals and is recommended by BOPRC.

The second approach is a simplified approach, which is conservative in order to ensure that adequate channel protection is provided. The approach still requires that velocities for the design discharge to be calculated and inputted into the equations. The design approach based on Figure 12.3 is:

- 1 Determine the discharge velocity for the design storm. For stormwater management structures the design storm is the maximum flow that can be carried by the pipe. This will normally be the ten-year design flow.
- 2 Enter that value into the following equation to determine the equivalent diameter of the stone.

$$d_s = 0.25 \times D_o \times F_o$$

Where

d_s = Riprap diameter (m)

D_o = Pipe diameter (m)

F_o = Froude number (compares inertia and gravity) = $V/(g \times d_p)^{0.5}$

d_p = Depth of flow in pipe (m)

V = Velocity of flow in pipe (m/s)

- 3 The thickness of the stone layer is 2 times the stone dimension. $DA = 2d_s$
- 4 The width of the area protected is 3 times the diameter of the pipe. $WA = 3 D_o$
- 5 The height of the stone is the crown of the pipe + 300 mm.
- 6 The length of the outfall protection is determined by the following formula.

$$La = D_o (8 + 17 \times \text{Log } F_o)$$

Where

La = Apron length (m)

g = 9.8 m/s^2

Figure 12.3 – Schematic of riprap outfall protection

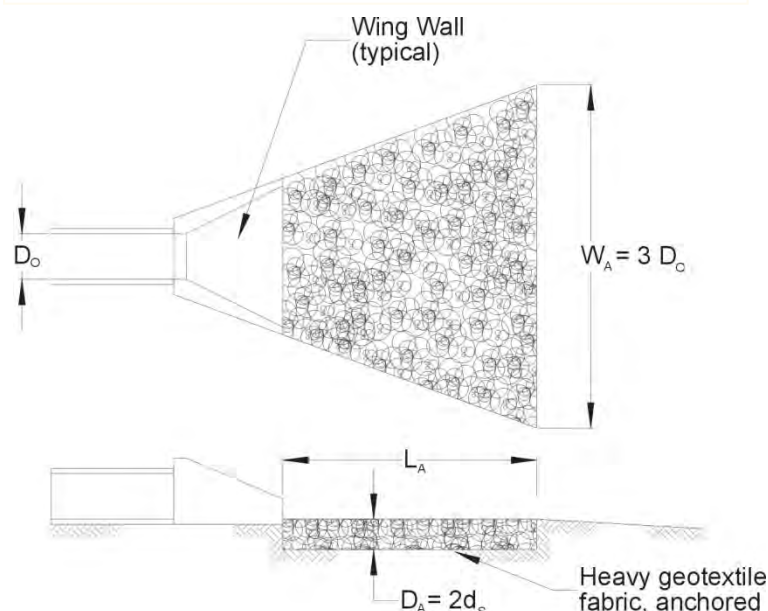

As can be seen from the equations, any reduction in the discharge velocity will reduce the stone size and apron length. Mechanisms to reduce velocity prior to discharge from the outfall are encouraged, such as drop manholes, rapid expansion into pipes of much larger size, or well up discharge designs.

12.5 Construction

Construction of the outfall protection must be done at the same time as construction of the pipe outfall itself. In terms of environmental protection and timing of construction, it is best to construct the outfall unit from the bottom up, to prevent concentrated flows from being discharged into an unstabilised location. If construction of the outfall system is done from the top end first, the entrance to the system should be blocked off to prevent flow from travelling through the pipe until the outfall protection is completed.

Outfall structures associated with stormwater management ponds shall be done in a similar fashion. Once the embankment has been completed and the pipe outfall structure installed, the outfall erosion protection must be constructed.

It is important that a sequence of construction be established and followed, such as, for example:

- 1 Clear the foundation area of trees, stumps, roots, grass, loose rock, or other unsuitable material.
- 2 Excavate the cross section to the lines and grades as shown on the design plans. Backfill over-excavated areas with moist soil compacted to the density of the surrounding material.

Riprap velocity dissipation at pipe outfall



- 3 Ensure there are no abrupt deviations from the design grade or horizontal alignment.
- 4 Place filter cloth and riprap to line and grade and in the manner specified. Sections of fabric should overlap at least 300 mm and extend 300 mm beyond the rock. Secure the filter cloth at the edges via secure pins or a key trench.
- 5 Ensure the construction operations are done so as to minimise erosion or water contamination, with all disturbed areas vegetated or otherwise protected against soil erosion.
- 6 For coastal sites, undertake construction at periods of low tide.

12.6 Operation and maintenance

Key tasks are:

- Inspect outlet protection on a regular basis for erosion, sedimentation, scour or undercutting.
- Repair or replace riprap, geotextile or concrete structures as necessary to handle design flows.
- Remove trash, debris, grass or sediment.

Maintenance may be more extensive as smaller riprap sizes are used, as children may be tempted to throw or otherwise displace stones or rocks.

12.7 Bibliography

City of Portland, Stormwater Management Manual, Adopted 1 July, 1999; revised 1 September, 2000.

Fortier, Samuel. and Scobey, F.C., 1926, Permissible canal velocities: Transactions of the American Society of Civil Engineers, v. 89, Paper no. 1588, p. 940-984.

Department of Natural Resources and Environmental Control, Delaware erosion and Sediment Control Handbook for Development, undated.

Ministry of Works and Development, Culvert Manual, Volume 1, Civil Division Publication CDP 706/A, August 1978.

North Shore City Council Coastal Outfalls, report prepared by Beca Carter Hollings and Ferner, October 2001.

U.S. Army Corps of Engineers, Hydraulic Design of Energy Dissipators for Culverts and Channels, HEC 14, July, 2006, *Metric Version*.

Washington State Department of Ecology, Stormwater Management Manual for Western Washington, Volume 5, Run-off Treatment BMP's, Publications No. 99-15, August, 2000.

Part 13: Retrofitting problem areas

13.1 Introduction

While implementation of stormwater management practices is most easily done during initial development construction there are many situations where the existing land use may be impacting on downstream areas. In these situations retrofitting stormwater management practices for a given catchment or sub-catchment may be beneficial.

When considering retrofitting, there are a number of items that need to be considered:

- Downstream flooding or stream channel erosion being adversely impacted by existing land use;
- Receiving system impacts by upstream generated contaminants;
- Appropriateness of a given stormwater management practice;
- Practice size needed to provide a substantial benefit;
- Land availability for the stormwater practice to be constructed;
- Maintenance access;
- Ability to get the drainage through the practice; and
- Cost (design, construction and operation).

The following sections provide discussion of the overall process of retrofitting.

13.2 Prioritisation of projects

Figure 13.1 provides a flowchart for the process by which retrofitting is progressed. There are several major elements of the decision process which includes whether solutions can be obtained through consenting and how to prioritise opportunities. The consenting process is the cleanest approach as those responsible for adverse impacts are responsible for solutions. Prioritising projects throughout the region may be contentious given limited funding and whatever approach to prioritisation is selected will be arguable. It is not intended that this approach will be based on geographically spreading projects around the region but rather to base retrofitting on need. As such there may appear to be some inequities in project selection, but the criteria presented are intended to be transparent and subject to scrutiny.

There are a number of different levels that need to be considered in a retrofit prioritisation process. Initially all problem situations go through the matrix detailed in Figure 13.1 and, if the initial analysis recommends it, the projects go onto a retrofit consideration list for funding and implementation. This list is only the first stage of project consideration.

Figure 13-1 Retrofitting Eligibility Matrix

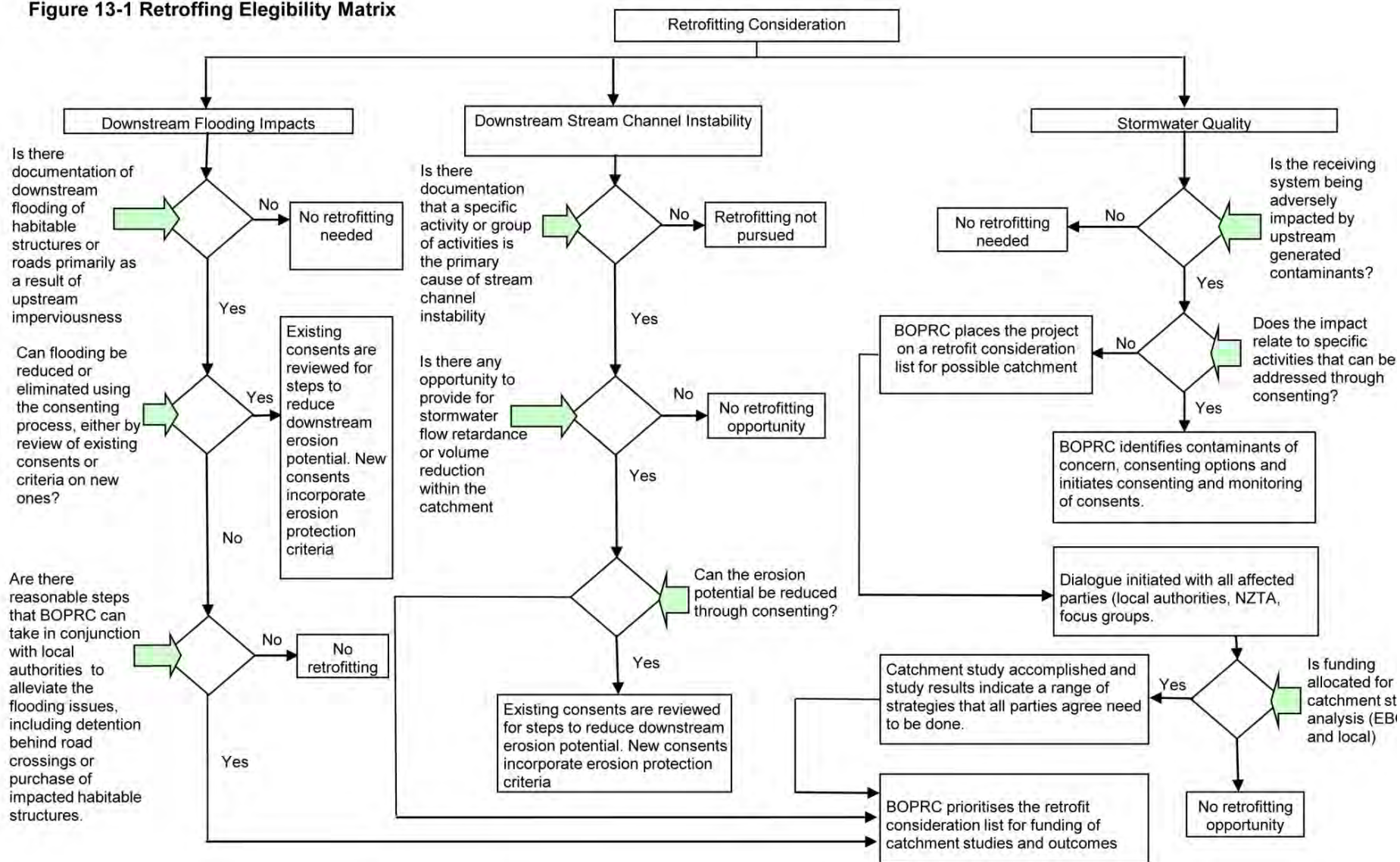

Initial consideration is given at a macro-scale with the following priority (highest to lowest) given to retrofitting.

- Projects related to public safety have the highest priority. This would include situations where flooding of habitable structures is a result of upstream urban land use.
- Co-operative projects are the next highest priority. Having a joint project with New Zealand Transport Agency (NZTA) or Western Bay of Plenty District would provide a better overall outcome, especially where the retrofitting addresses overall catchment problems. In a given situation it may also involve Housing New Zealand.
- As discussed in Section 3 of these guidelines, water quality issues have a high priority in consideration of streams, ground, estuaries, lakes and harbours. In terms of priority, water quality retrofits would have a beneficial effect on a wider range of receiving systems than would stream erosion issues.
- Stream erosion issues with primary consideration given to local erosion and then to general stream degradation.

It is anticipated that the list will be a living document, and that new projects will be periodically added while others are removed or move further down the list based on the prioritisation process.

13.3 Overall retrofitting selection process

Once projects have been prioritised, that is only the first stage of an overall process towards retrofitting a given highway. Figure 13.2 provides the overall process from project evolution as a retrofit from problem identification to implementation.

Once project prioritisation has been done feasibility studies would need to be done to determine whether a project is a realistic possibility. Feasibility studies include the following items:

- Magnitude of impact;
- Appropriate practice availability;
- Space availability;
- Ability to get run-off to the practice;
- Magnitude of benefit;
- Cost; and
- Maintenance access.

These items are discussed in more detail in the following subsections.

Figure 13.2 - Overall process for retrofit selection

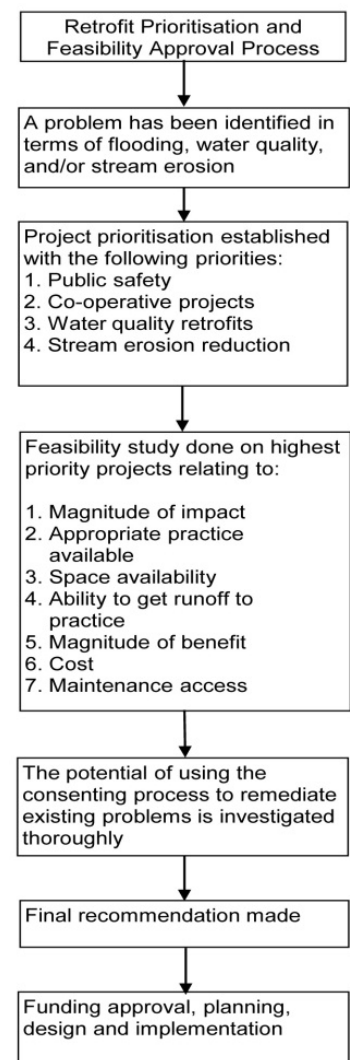

13.3.1 Magnitude of impact

(a) Public safety

In terms of public safety, once public safety is recognised as an issue, the project is a high priority. In terms of ranking within this category, the greater the number of individuals who may be adversely impacted by flooding, the higher up the project would rate on the prioritisation list.

It is important to mention the difference between public safety and property flooding. Property flooding (often due to its location within a floodplain) is not considered a priority for retrofitting. The following public safety issues are considered a high priority:

- Flooding of habitable structures; or
- Increased flood levels on roads, which could jeopardise public safety.

(b) Co-operative projects

Working with a another entity (NZTA, Rotorua, Tauranga, Western Bay of Plenty District Council, etc.) to solve a catchment or sub-catchment issue related to flooding, water quality or stream erosion ensures that solutions are developed having a broader context and thus providing greater potential benefit. In terms of prioritising, the following priorities are provided in the context of higher ranking to lower:

- Catchment-wide solutions;
- Sub-catchment solutions; and finally
- Joint projects that may be done in conjunction with a specific development.

Taking catchment-wide or sub-catchment-wide solutions will rely on sufficient catchment or sub-catchment studies being done to identify problems and solutions prior to prioritisation of these projects.

While joint projects may be done in conjunction with a private developer, the project needs to have a broader context than just the area of development to warrant BOPRC consideration of retrofit potential.

(c) Water quality retrofits

Magnitude of impact can be somewhat qualitative in given situations but receiving system impacts can be quantified using contaminant spread sheets and unit loading approaches. An important issue is the determination that a given receiving system is being degraded either through sediment analyses or via aquatic organism decline. Once that determination has been made and contaminant load modelling or monitoring is done that identifies a given land use as being a major source of degradation, then retrofitting can be prioritised.

Retrofit of a dry pond with a small weir to create a wetland



The degree of impact is important and will have to be made on a case-by-case basis. The ARC's Environmental Response Criteria (ERC) (ARC, 2004) is an example of guidance towards receiving system impact consideration. The ERC are conservative thresholds that provide an early warning of environmental degradation, and they provide guidance as to when intervention may be necessary to protect or mitigate for environmental degradation.

Another factor to consider for water quality retrofit ranking is having a project benefit multiple receiving systems. Providing a water quality retrofit of a given land use that drains into a stream and then an estuary would be given a higher priority than a project that only benefits one receiving system. A variation to this "rule of thumb" would be a receiving system that is much degraded and a retrofit project would have a significant beneficial effect on it.

For the most part, water quality retrofits will be done to resolve a locally recognised problem. It is anticipated that local government monitoring (sediment, water quality, aquatic organisms) will provide the background information that retrofitting is responding to.

(d) Stream erosion reduction

Stream erosion can come in two different forms:

- Localised erosion; or
- General degradation.

Localised erosion can be caused by inadequate energy dissipation at culvert or pipe outlets and can be relatively easy to resolve through design and implementation of energy dissipation outlet protection.

Retrofit of a culvert with extended detention for stream channel erosion reduction and some water quality benefit



General stream channel degradation is more complicated to address, possibly due to increased flows on a more frequent basis. It may be difficult to determine whether a given land use is a primary cause of the degradation. Larger catchments reduce the potential for any one activity to be identified as a principal cause of erosion. The most common situation where a development having a high degree of imperviousness can individually cause channel instability is where the catchment is relatively small and site imperviousness proportionately large. Site imperviousness in excess of 10% of a total catchment area could be a major source of general channel degradation.

Prioritisation should be based on the degree of general degradation.

13.3.2 Appropriate practice available

Practice availability depends on the stormwater related problem that is being addressed. The following items consider the types of practices that may be appropriate to mitigate a specific problem.

(a) Downstream flooding impacts

If downstream flooding impacts are identified, the issue then becomes whether appropriate action can be taken to reduce those impacts. There are three practices that are generally appropriate:

- Detain flows using stormwater detention ponds;
- Detain flows upstream of cross-culverts to provide flood storage; or
- Purchase or flood proofing downstream habitable structures.

If these options are not available, it may not be possible to mitigate this effect and further project consideration would be discontinued unless it can be considered cooperatively with another entity, which could expand possible solutions and allow for cost sharing.

(b) Downstream stream channel

There are only three ways that this can be addressed:

- Reducing the volume of stormwater that is discharged; or
- Providing extended detention storage of run-off for 1.2 times the water quality rainfall event using stormwater detention ponds (per Section 6.2 of these guidelines); or
- Armour downstream banks to protect banks from erosion.

Infiltration of existing run-off is possibly the only practice available for reducing the volume of stormwater. Retrofitting an entire sub-catchment with rain tanks will not normally be practical and may not be effective as much of the run-off is delivered by other impervious surfaces. This will depend on soils, slopes and depth to groundwater or bedrock (see Section 5.2) and may not be an available option in a given situation for those reasons just provided or lack of space.

The other option relates to temporary storage and release of stormwater run-off for 1.2 times the water quality rainfall over a 24-hour period. The amount of storage required achieving this needs to be considered on a case-by-case basis for determination of site suitability.

Armouring downstream channel boundaries may address a symptom of the problem more than resolving the problem and is generally considered as a last resort. Armouring channel boundaries may not reduce erosion potential of other parts of the stream.

(c) Stormwater quality

Providing water quality retrofit will depend on a number of items but may be the easiest of the three retrofit problems to resolve. Retrofitting for water quality treatment will depend on:

- The contaminants of concern; and
- Site space availability for stormwater treatment.

The contaminants of concern have a significant impact on whether a practice can be retrofitted. Some contaminants exhibit more of a first flush effect than do others.

There will be a first flush effect of zinc and copper but not a dramatic effect. There will be a build-up of zinc and copper from impervious surfaces but the load will be continually produced during the storm by vehicle traffic continuing to stop and start. The first flush may be more pronounced for dissolved metals than particulate ones and will be more pronounced for hydrocarbons. In addition, the shape of the catchment and total area may dampen a first flush effect from a catchment-based consideration. Discussion of first flush effect (Minton, 2002) shows that for a catchment imperviousness of 50% that zinc does have a pronounced first flush effect while copper has a lesser effect. Sediment has a slight first flush effect. His consideration of a first flush was 2.5 mm of run-off.

In addition, Minton considers the effect of percent impervious surface and rainfall depth on percent of annual load. For a catchment having 50% imperviousness the following Table 13.1 is presented.

Table 13.1 Run-off depth intervals 50% catchment imperviousness. Numbers are percentage of annual load (Minton, 2002).

Contaminant	Run-off depth interval (mm)				
	0-2.5	2.5-7.6	7.6-12.7	12.7-19	19-25
Zinc	40	36	11	4	9
Copper	21	39	20	6	14

As can be seen, capturing the first 7.6 mm of run-off may provide a significant reduction in annual load for zinc and copper. As indicated in Table 6.7, various practices have a high potential to remove a given contaminant but no practice removes 100%. As an example, International literature cites effective removal of zinc and copper by wetlands and an Auckland specific study (Larcombe, 2002) provided copper reductions of 79% for total copper and 62% for dissolved copper and zinc reductions of 86% for both total and dissolved zinc. If a wetland were sized for the first 7.6 mm of run-off, it would treat 76% of the zinc load. If the wetland removed 86% of the zinc, it would remove approximately 65% of the zinc load. Is that level of removal beneficial to the receiving system?

Once a decision is made regarding the type of practice that is needed to reduce contaminants of concern on a given highway and the storm size that should be used, sizing of that practice needs to be determined. Available space needs to be considered and lack of space may prevent a project from being progressed.

13.4 **Space availability**

Consideration of all three areas of concern for which retrofitting may be necessary demonstrates that space availability for stormwater management is an important aspect of the decision matrix. While mentioned in prior section discussions it is mentioned individually due to its prominence.

Space has to be available or retrofitting cannot be done. Doing a co-operative project with territorial authorities or even with a developer may provide the requisite space.

In general, retrofitting is more practical when considered as a co-operative project than attempting to reduce effects individually.

13.5 **Ability to get run-off to the practice**

While there may be space available to retrofit a stormwater management practice, gravity may prevent a given location from being feasible. Elevation differences may mean that an available area is uphill from where the run-off is generated and run-off cannot be directed to the location. In addition, existing development will have a drainage system to discharge stormwater downstream and that drainage system may not allow for flows to go to a treatment system.

The existing site drainage system and site topography have to be considered to determine whether a retrofit is practical.

13.6 **Magnitude of benefit**

As mentioned briefly in Section 13.3.2(c), the example of a wetland being able to remove 65% of zinc may be an important level of removal but the actual benefit may be questionable if degradation of a receiving system will continue at a lower rate. The ability of a retrofit to individually, or in conjunction with other efforts, reduce existing adverse effects to receiving systems must be considered.

The decision whether a given contaminant reduction provides value to a receiving system depends on a case-by-case analysis of monitoring data and modelling of long-term effects. In many situations, retrofit will be considered in response to a local problem identification but retrofitting actions should also be considered from a catchment-wide perspective.

The magnitude of the benefit cannot be discussed sooner in the feasibility analysis until a decision can be made regarding whether a practice can be used at a given location and what level of contaminant reduction can be provided. Once those questions are answered, magnitude of benefit can be considered.

A more detailed discussion of magnitude of benefit is beyond the scope of this Standard.

13.7 Cost

Cost is another important component of the retrofit approach. It can be considered from several different perspectives.

- Cost versus magnitude of benefit for a given project;
- Total cost for a given retrofit; or
- Total cost for the overall retrofit programme.

13.7.1 Cost versus magnitude of benefit for a given project

This has been referred to several times in individual discussions (water quality and magnitude of benefit) and needs to be considered. Initial consideration of cost/benefit needs to be given to whether a retrofit can provide a benefit to a receiving system. It may be that removing only 10% of a given contaminant will provide no measurable improvement to receiving system health unless done in conjunction with other projects that are programmed or intended.

Once the decision is made that a given retrofit project will result in a measurable improvement to receiving system health, the cost of that improvement must be determined and weighed in conjunction with the benefits provided. This is a difficult process for stormwater related issues beyond public safety ones. Providing value to aquatic receiving systems is not well defined and tends to be more qualitative than quantitative. At this time it is recommended that consideration be given to retrofitting when a reversal of trends is indicated rather than just a reduction in rate of increase.

It is important that project cost reflect whole-of-life costing rather than just construction. Whole-of-life costing will reflect the long-term cost of maintaining continued function in addition to design and construction. This is critical in areas where space is limited and maintenance access may require road closure or work being done at night versus during the day.

This will then be considered in conjunction with other projects around the region to consider the benefits versus costs for all projects.

13.7.2 Total cost for a given retrofit

While a given project may be feasible from a design and space allocation perspective, the overall cost of project implementation and operation may make a project impractical. There are several examples of this.

- Due to slopes and space availability, a retrofit may require retaining walls or to fit in a confined space. While there would be water quality benefit, the cost to construct the practice would be very high. In those situations it may provide greater benefit to do several other projects than the one being considered.
- If space is limited, design could be based on providing a smaller surface area for treatment than would normally be recommended for a new consent. This would necessitate maintenance on a more frequent basis. If there are maintenance access problems the whole-of-life costs may be too high to justify project implementation.

To some degree, the final decision will be based on a qualified determination of benefit but the feasibility process provided here will allow greater quantification of benefits versus cost to assist in reducing uncertainty in decision-making.

13.7.3 Total cost for the maintenance programme

This is an item that needs to have a basic assured funding base so that continuing efforts may be undertaken. Without having a dedicated funding source proactive approaches cannot be done. Too often, local programmes are focused on requesting funding to address a specific problem without having a proactive approach to problem solving.

It is important that operation and maintenance is assured so that investigations and prioritisation of actions can have a solid foundation. Relating actions to specific catchments will offer a comprehensive approach to problem solving by highlighting problem areas, identifying those stressors that cause the problem and considering options for solution. These activities cannot be undertaken without assurance of funding on a long-term basis.

Stormwater pond being maintained by having the silt sucked out by vacuuming



13.8 Maintenance access

Any practice that is constructed will eventually need maintenance and that maintenance can only be provided if there is access to the site for maintenance to be done. An essential element of any retrofit project design is the need to consider future access to the practice for maintenance equipment.

13.9 Taking advantage of opportunities

Retrofitting presents many unique, complex challenges – institutional, technical and financial. Institutionally, retrofitting is best accomplished through catchment approaches. Technically, a given approach may be land intensive and inappropriate for use in highly urbanised areas, where land is scarce and expensive.

It is important to have good communication and coordination between all of those entities involved in a given project, and this needs to be occurring early in the problem identification process to avoid conflicts and to allow for synergies to occur. Retrofitting can be done through an almost limitless number of ways.

Restoration of an urban stream in Christchurch in association with community walkways



These include the following:

- Retrofitting existing stormwater quantity control structures;
- Using existing road crossings to impound stormwater;
- Demonstration projects;
- Use of new consenting to exceed individual project benefits; and
- Retrofitting through education.

13.9.1 Retrofitting existing stormwater quantity control structures

Nearly any modification of an existing run-off control practice which will slow velocities, increase detention time or promote run-off flow through vegetation will increase the removal of contaminants. The simplest way to retrofit stormwater detention ponds is to modify the existing outlet structure to provide extended detention or provide a normal pool of water for a wetland.

If site conditions are appropriate, dry detention or failing infiltration systems can be converted to wet systems to improve contaminant capture. Any permanent pool may have to be excavated below the existing practice invert so storage volume is not reduced. A retrofit could be as simple as adding a weir above the invert of a pipe to provide for some detention of water.

13.9.2 Using existing road crossings to impound stormwater

Roads and highways, by their linear nature cross catchment boundaries. Where they pass over drainage systems there is generally an embankment that elevates the roadway above a given floodplain elevation. The upstream inlet of the highway can be modified to extend detention time.

Grassy medians, shoulders, clearways and interchanges all provide opportunities for retrofitting for water quality treatment. Obviously, these options would have to be coordinated and approved by the appropriate road or highway responsible entity (territorial authority, NZTA, land owner, etc.).

13.9.3 Demonstration projects

Retrofitting often is done as a demonstration project. It provides an opportunity not only to treat stormwater but to test innovative treatment practices. They tend to be limited to showing examples of innovative practices in a forum where they are visible. Visibility is important when the intention is to increase public awareness of proactive Council efforts to address stormwater problems or to have people become aware of practices that may be promoted on a more widespread basis (possibly water tanks).

The value of demonstration projects as an educational tool can be very important. The State of Maryland (Figure 13.3) did a stormwater management theme park at a local reserve where people could visit, look at interpretive signs and gain a better understanding of stormwater issues and control. The ARC is doing a similar project at a local park (Botanic Gardens in Manukau City as shown in Figure 13.4).

Figure 13.3 - State of Maryland Stormwater Management Theme Park schematic

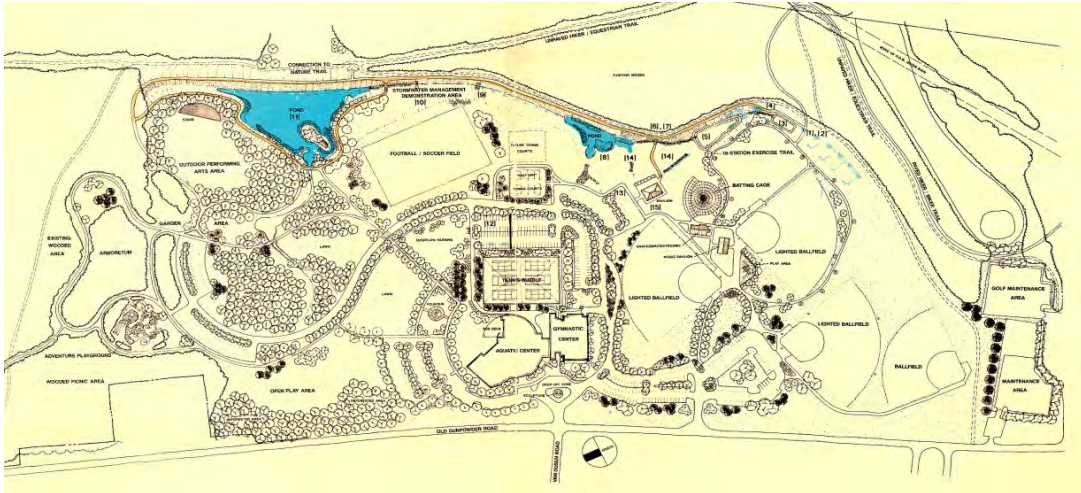

Figure 13.4 - Auckland Regional Council Stormwater Demonstration Area – Botanic Gardens



There are many opportunities to make the public more aware of stormwater issues.

A new development may provide an opportunity to incorporate some retrofitting as a cost share initiative or provision of adjacent area retrofit as a consent condition. It may be that an increased density could be allowed for land that may provide broader treatment than for an individual development. One example may also be when a road is widened and treatment must be provided for the new section. It may not be possible to split the new road section from the existing and treatment can be provided for the whole road.

13.9.4 Retrofitting through education

Public education can result in a significant, yet difficult to quantify, water quality benefits. Every day activities add contaminants to streets, parking lots, lawns and other surfaces. Public educational efforts on reducing contaminants can be an effective retrofitting tool. Possible topics can include disposal of household chemicals and automotive waste, proper use of lawn fertiliser and pest control chemicals and water tank installation may provide benefits.

Public education can also increase the popularity and effectiveness of having the public report problems. By increasing awareness of contaminant indicators and having a simple notification system can assist in reducing contamination related to a specific instance.

Environmental education in existing urban areas can provide one of the most practical and cost effective approaches to contaminant reduction.

13.10 Bibliography

Auckland Regional Council, Blueprint for Monitoring Urban Receiving Environments, Technical Publication No. 168 revised edition, August 2004.

Minton, Gary R., Stormwater Treatment: Biological, Chemical and Engineering Principles, Amica International Ltd., 2002.

Larcombe, M., Design for Vegetated Wetlands for the Treatment of Urban Stormwater, a monitoring report done for the Auckland Regional Council, 30 April, 2002.

Watershed Management Institute, Institutional Aspects of Urban Run-off Management: A Guide for Program Development and Implementation, May 1997.

Part 14: Catchment wide considerations incorporating LID

14.1 Introduction

As stated earlier, BOPRC strongly endorses LID. While LID can be implemented at an individual site and subdivision level, the greatest benefit of an LID approach would be consideration from a catchment wide basis. This approach would allow land use decisions to be made based on land sensitivities, impacts to receiving systems and needed densities of population. It is considered with additional considerations than are site or subdivision developments as more consideration can be given to land use decisions rather than ways to mitigate impacts.

The ability to implement LID at a catchment level is limited in brownfields catchments but is very appropriate in catchments where new development is expected. In this situation consideration can be given to intended land use densities where an overall density can be achieved via greater intensification in some areas and reduced intensification in other areas.

This section consists primarily of a checklist and several case studies to demonstrate LID at a catchment level.

14.2 Catchment checklist

The following checklist shown in Table 14.1 should be completed in conjunction with the checklists provided in Section 9. It will become obvious which questions are pertinent from those checklists with the catchment checklist being an overlay.

Table 14.1 Catchment planning considerations.

Consideration	Yes	No
<i>Greenfields</i>		
Have all perennial and intermittent streams been identified?		
Has catchment geology been done and are areas with instability identified?		
Has a topo map of the catchment been done?		
Have development densities been assigned?		
Can earthworks be limited?		
Can development clustering be done to protect streams and reduce earthwork requirement?		
Can headwater streams be protected from hydrological change?		
Can total volumes of run-off be reduced from a conventional approach?		
<i>Brownfields</i>		
Have all perennial streams been identified?		
Has the storm drain system been identified and capacities determined?		
Can redevelopment within the catchment provide opportunities for reduction in impervious surfaces?		
Has consideration been given to source control of contaminants?		
Can redevelopment provide for stream rehabilitation or daylighting?		
Can redevelopment provide for vertical growth and create additional open space?		

14.3 Case studies

There are two case studies that provide an evolutionary path for LID at a catchment level in New Zealand. The two case studies are the following:

- Flat Bush Catchment in Manukau City; and
- Long Bay Catchment in North Shore City.

The Flat Bush Catchment is discussed first as that catchment study and consent were done prior to the Long Bay Catchment, which has been through the Environment Court.

14.3.1 Flat Bush Catchment

It needs to be reiterated that the Flat Bush Catchment Management Plan predates the Long Bay one.

As such, there are aspects of the Flat Bush approach that would be changed today, but this approach was an evolutionary step prior to the Long Bay Plan. It would be expected that the next catchment management approach would be an evolutionary step beyond the Long Bay one, as it is a step beyond the Flat Bush Plan.

14.3.2 Specifics to the Flat Bush Catchment

- Predevelopment land use was predominantly rural.
- Catchment area 1,735 ha.
- Drains into Otara Creek and discharges to Otara Lake and then the Tamaki River.
- Existing streams below headwater streams have been degraded and somewhat modified by farming activities.
- The district plan was changed to accommodate urban development of approximately 50,000 people.
- The receiving environment is depositional and the development should be designed to achieve the best practicable reduction in sediment and contaminant discharge.

14.3.3 Stormwater management objectives

- Manage the volume and peak flow rate and the passage of stormwater run-off to limit stream erosion.
- Manage the peak flow rate of stormwater run-off to avoid increased flood risk within the catchment.
- Manage the discharge of contaminants as far as practicable to avoid those contaminants reaching high value receiving environments.
- Retain dry season stream flows.
- Provide for ongoing operation and maintenance of stormwater assets.
- Maintain fish passage.
- Protect high value waterways.

The pre-development land use is shown in Figure 14.1.

Figure 14.1 - Flat Bush predevelopment land use

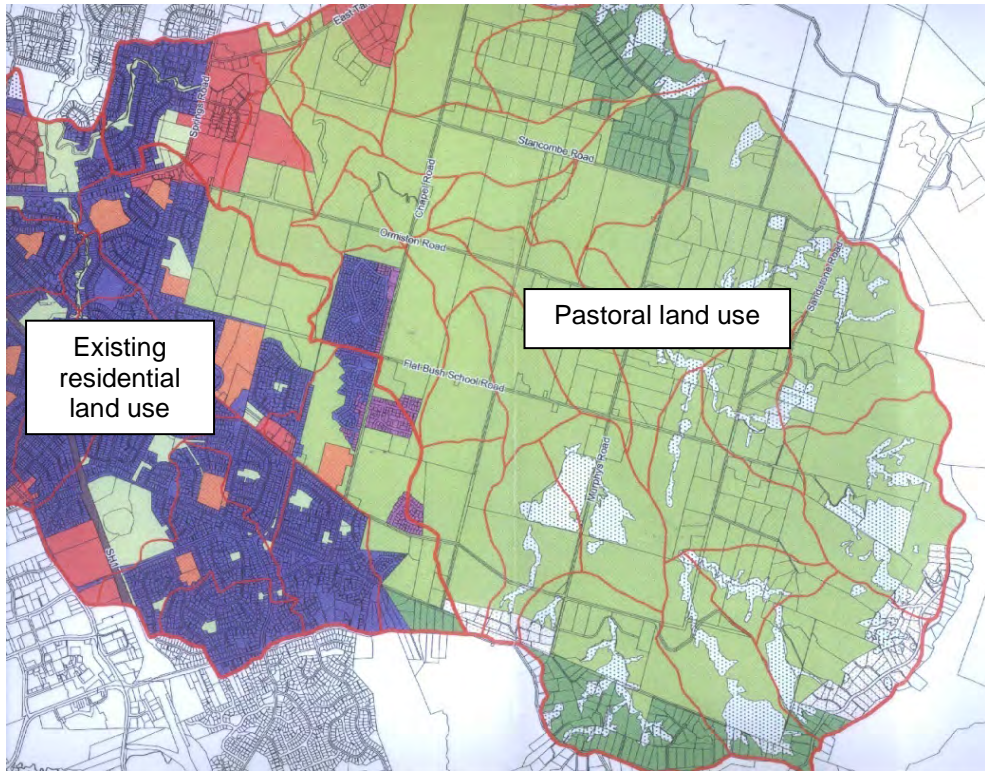

The existing stream network is shown in Figure 14.2.

Figure 14.2 - Existing stream network

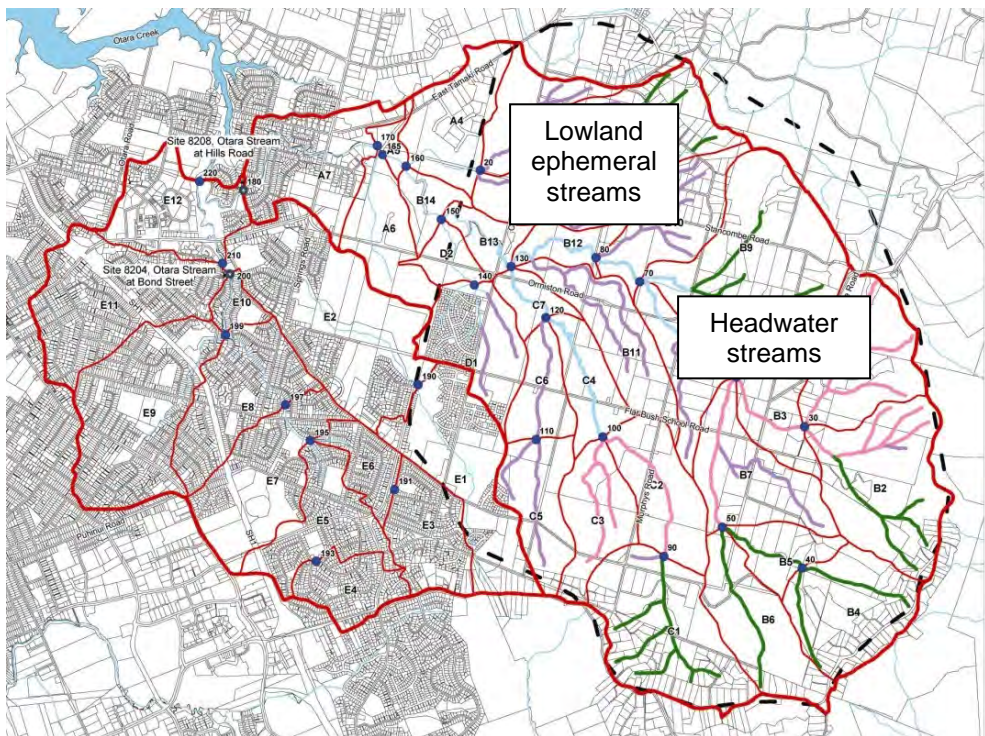

14.3.4 Upper catchment general approach

- Revegetation (general and riparian).
- Dispersal of stormwater by dissipation over a broad area.
- Water tanks.
- Treatment and flow control.

Middle and lower catchment general approach is a sub-catchment based approach, which relies on stormwater collection in ponds before discharge into protected streams, is necessary to meet the stormwater quality, extended detention and flood peak attenuation criteria.

14.3.5 Design concepts

- Discharge through pond systems is the most appropriate method in most situations and indicative locations are shown in Figure 14.4;
- Where practicable, overland flow paths should be directed to ponds to attenuate larger floods;
- Floodplains and stormwater pond locations must be retained;
- Discharge to the stormwater management areas should be through a vegetative filter strip, limited to 5 m in width.

14.3.6 Stream strategy

There are three types of stream status:

- Fully protected streams in stormwater management areas, which are linked to headwater streams and on which there shall be no on-line ponds;
- Streams in stormwater management areas which are not linked to headwater streams and where on-line ponds are permitted; and
- Lowland ephemeral streams, which may be modified or piped.

14.3.7 Floodplain strategy

As an underlying principle, as far as practicable, the full existing extent of flood plains should be retained. This achieves a range of objectives including:

- Flood peak attenuation;
- Provision of riparian planting and protection of stream habitat; and
- Protection of streams from channel erosion.

14.3.8 Impervious coverage assumptions

Impervious coverage assumptions are shown in Table 14.2 and overall catchment land use is shown in Figure 14.3.

Table 14.2 Typical impervious area assumptions.

Land use type	Coverage range (%)	Additional impervious (%) [*]	Total impervious area (%)
Flat Bush town centre	80	20	100
Flat Bush neighbourhood centre	80	15	95
Flat Bush Residential 1	35-55	20-25	55-80
Flat Bush Residential 2	40-45	20-25	60-70
Flat Bush countryside transition	15	0-5	15-20

^{*} Additional impervious surfaces include an allowance for driveways, paths and patios.

Figure 14.3 - Proposed catchment land use

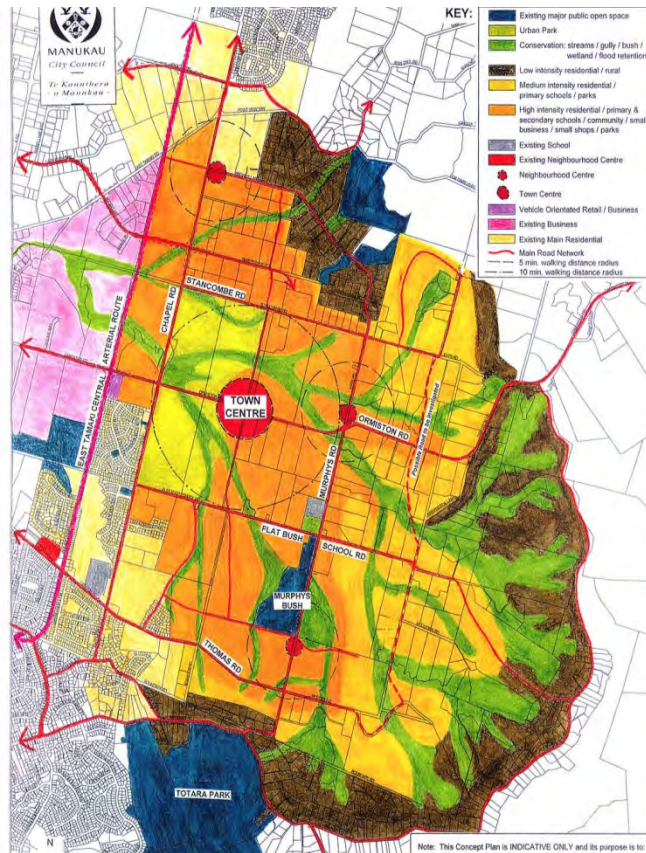

14.3.9 Stormwater management pond considerations

Stormwater management ponds

Stormwater management ponds are the primary method of management and are designed to achieve three principal objectives:

- Protection of water quality through removal of contaminants by wet ponds, extended detention, filtration and passage through wetlands vegetation;
- Extended detention via release of rainfall from 34.5 mm rainfall over a 24-hour period;
- Attenuation of the 100-year flood at 80% of the predevelopment flood peak.

There are 47 proposed wetlands detailed in the Catchment Management Plan. Those wetlands are shown in Figure 14.4.

Figure 14.4 - Location of stormwater wetlands in the catchment

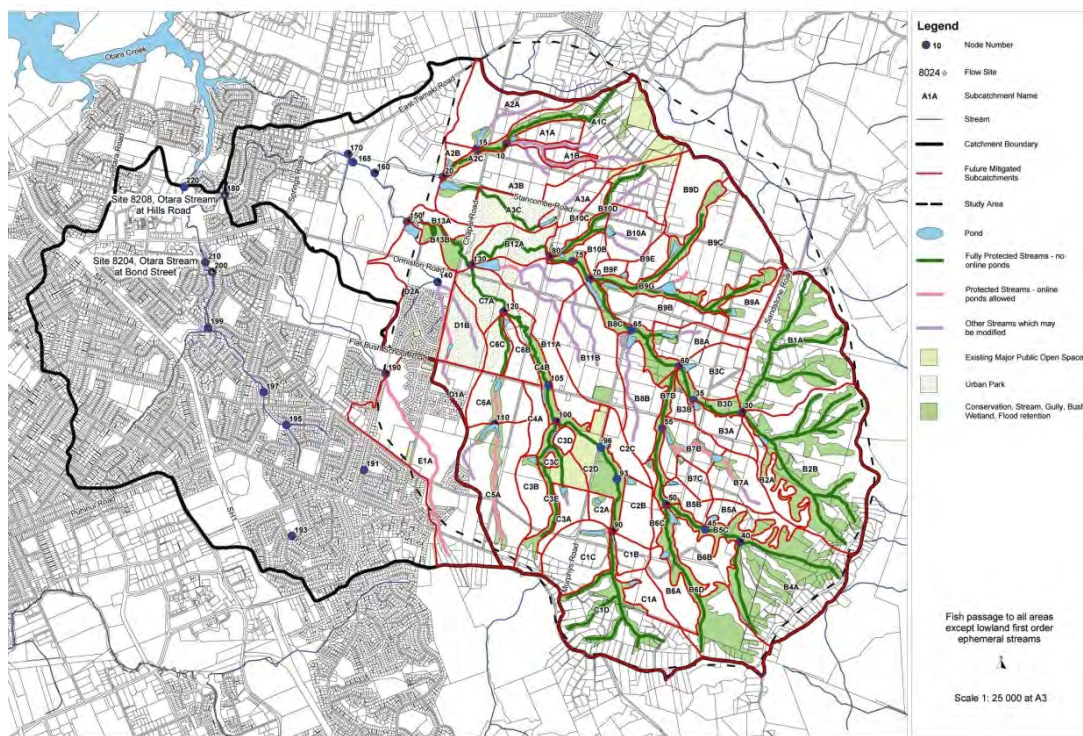

The Flat Bush Catchment is being developed at this time (2010).

14.3.10 Long Bay Catchment

The Long Bay Catchment boundaries are shown in Figure 14.5.

The Long Bay Catchment development approach is a more recent evolutionary step in an LID approach to catchment development. The genesis of the approach is based on North Shore City Council (NSCC) desire to allow urbanization to occur in this catchment. The Auckland region has a Metropolitan Urban Limit (MUL) that reduces sprawl potential outside of accepted urban limits and the NSCC won the right to shift the MUL and allow urbanization by decision of the Environment Court.

Receiving system concerns related to stream channel physical structure protection and water quality impacts to receiving systems (Vaughan's Stream and marine reefs off the coast). The catchment is very steep with geotechnical issues throughout the catchment and there was a major concern that intensification in the headwater areas would cause significant stream stability issues that could not be mitigated for if overall imperviousness was high. Figure 14.6 shows overall catchment topography and stream long sections. As can be seen in the long section, the stream slope becomes very steep as the top of the catchment is approached.

Figure 14.5 - Long Bay Catchment Boundaries

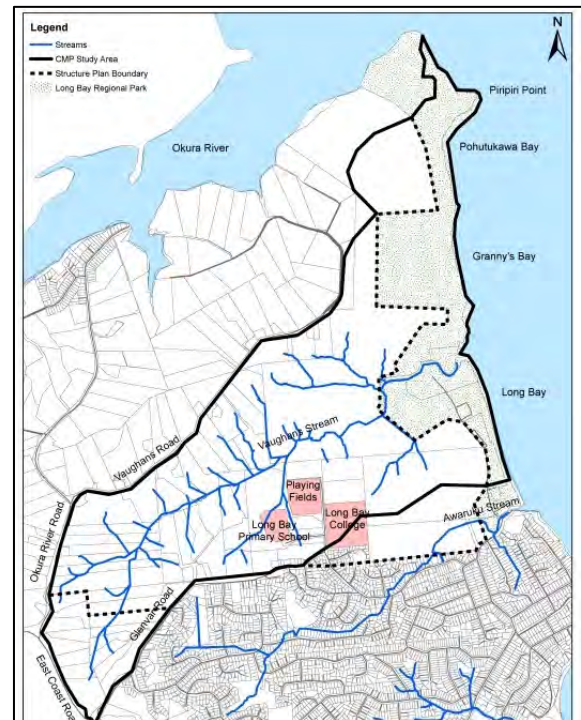
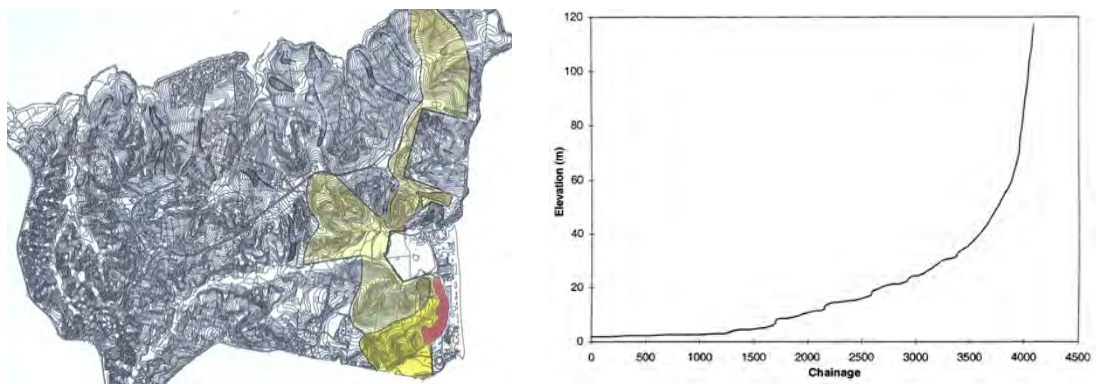

Figure 14.6 - Catchment topography and stream long section



The catchment topography was extremely important in determining an overall catchment land use as urbanization in the headwater areas was kept to a low level for which mitigation could be provided, while more intensive development was prioritised in the lower catchment where more conventional stormwater management could be implemented.

A key element in protection of streams was their identification and the establishment of riparian corridors around all the perennial streams as shown in Figure 14.7. There was limited stream enclosure proposed in the high intensity development area, but for the most part streams were identified and protected in riparian corridors.

Figure 14.7 - Stream tributaries and their associated riparian zones

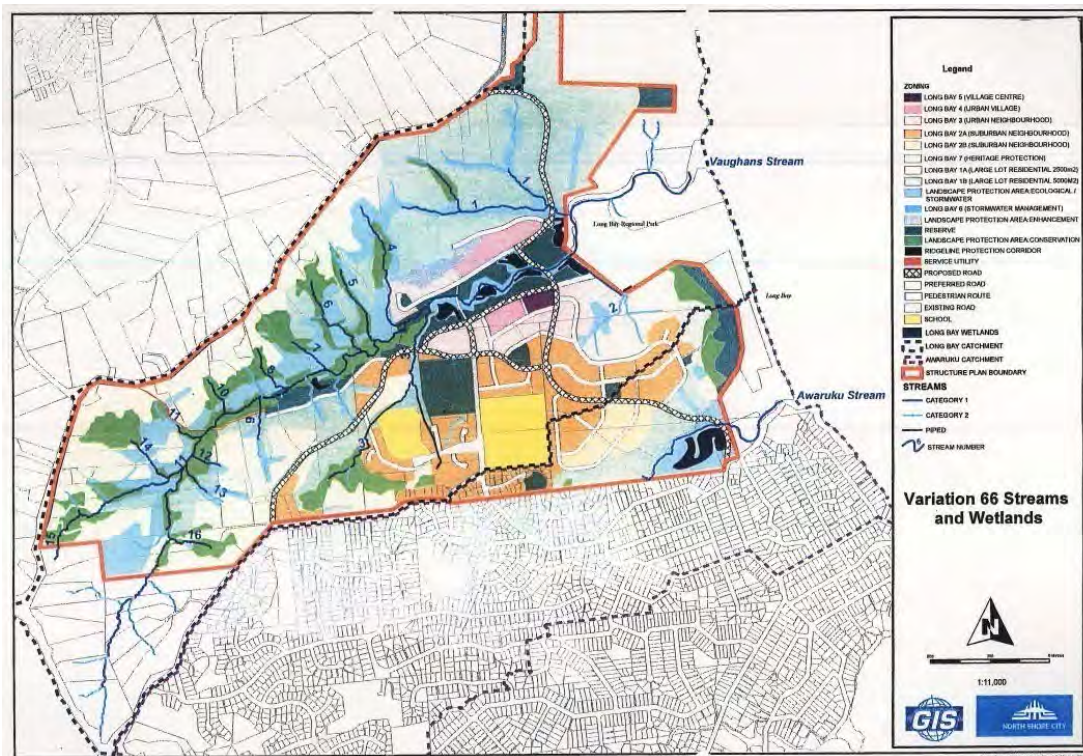

The ultimate land use plan selected for the catchment by NSCC had an interesting approach where NSCC established two zones in the catchment; zones A and B. Zone A is used to maintain low density urban development to reduce mass earthworks and minimise increased impervious surfaces in that Zone. Streams and watercourses are retained in their natural state in this zone. Maximum impervious surfaces cannot exceed 15% of the site or 500 m², whichever is greater and impervious areas are to be fully mitigated by on-site management. Fully mitigated includes managing run-off volumes as far as practicable to predevelopment levels.

Zone B comprises the lower catchment where more conventional stormwater management and higher density development are proposed. The area contains urban neighbourhoods, an urban village and a village centre. Imperviousness will be high in these areas. The stream protection B areas are required to provide a level of on-site treatment in conjunction with off-site measures. These would include primarily rain tanks and off-site wetlands.

The zones and catchment land use are shown in Figure 14.8.

Figure 14.8 - Catchment development zones and land use

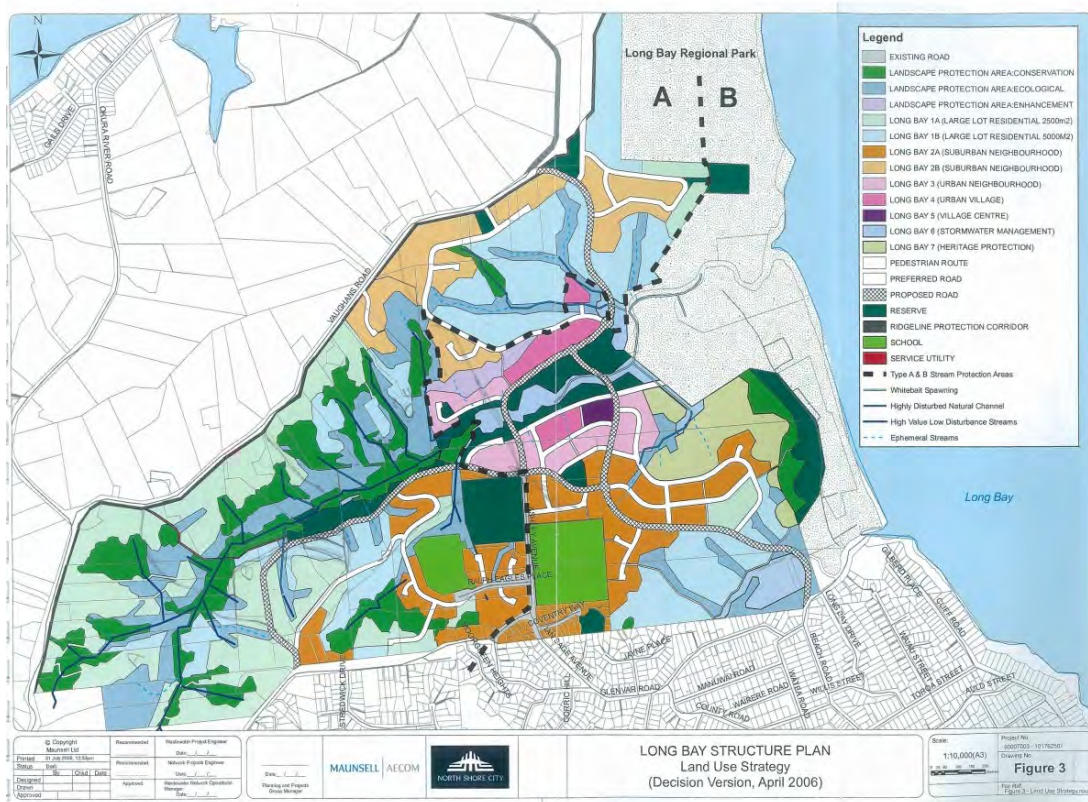

Land use in the catchment was the following as shown in Table 14.3.

Table 14.3 Long Bay land use designations.

Long Bay 1 Zone	Minimum site areas
Long Bay 1A	2,500 m ²
Long Bay 1B	5,000 m ²
Long Bay 2 Zone	Minimum site areas
Long Bay 2A Zone	600 m ²
Long Bay 2B Zone	1,000 m ²
Long Bay 3 Zone	
Minimum net site area	220 m ²
Maximum net site area	350 m ²
Long Bay 4 Zone - Urban Village	1,500 m ² (intended for apartment buildings of four stories)
Long Bay 5 Zone - Village Centre	1,500 m ² (small scale business, mixed use and apartments)

Table 14.4 shows imperviousness associated with the land use is the following:

Table 14.4 Impervious percentages for individual land uses.

Land use	Fully developed (ultimate) impervious area percentage
Community Centre (Long Bay 5 Zone)	100%
Community facilities	100%
Urban village (Long Bay 4 Zone)	90%
Urban neighbourhood (Long Bay 3 Zone)	70%
Suburban neighbourhood (Long Bay 2 Zone)	50% (to a maximum of 500 m ²)
Large lot (2,500 m ²) (Long Bay 1A Zone)	15% or 500 m ² , whichever is greater
Large lot (5,000 m ²) (Long Bay 1B Zone)	15% or 500 m ² , whichever is greater
Landscape protection	0%
Reserve	0%
Ridgeline protection corridor	0%
Stormwater management area	0%
Landscape protection after earthworks	0%
Arterial road reserve	75%
Subdivision road reserve	61%

Another interesting component of the catchment-wide approach was the consideration of effective imperviousness in relation to stream protection. NSCC used international literature to determine stream health if direct connection of impervious surfaces to stream was limited. While the approach has not been proven based on field evaluation, it is a logical approach and one that will provide greater protection to the streams than not having the approach.

Effective imperviousness is based on the concept that stormwater run-off should pass through stormwater management practices such as water tanks, rain gardens, swales, filter strips or wetlands prior to being discharged into streams. This would slow the delivery of water down and reduce adverse effects to the physical structure of streams. The concept is shown in Figure 14.9. As the concept is relatively recent there has been little opportunity to investigate its effectiveness but it is a logical approach.

Figure 14.9 - Catchment imperviousness versus stream quality

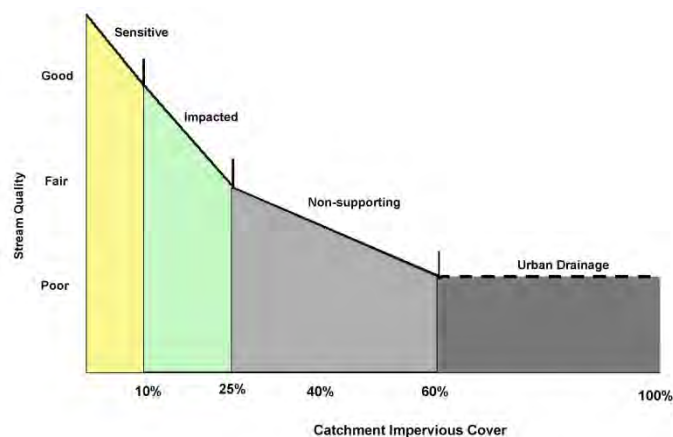

The Long Bay approach to urban development has several evolutionary aspects that are important in consideration of future catchment management plans.

- 1 Urban development areas were determined by catchment sensitivities;
- 2 Streams were considered as important natural features;
- 3 Natural areas of bush were protected;
- 4 Water quantity and quality issues were considered on a catchment-wide basis; and
- 5 Levels of imperviousness, including effective imperviousness, were considered in the context of protection of stream health.

The catchment-wide LID approach taken by NSCC was challenged by a developer and was taken to the Environment Court. The Court affirmed the approach taken by NSCC, which was an important step in verifying that LID was a valid approach to catchment development in other situations.

14.4 **Bibliography**

Manukau City Council, Flat Bush Catchment Management Implementation Plan, Version A6, June 2004.

North Shore City Council, Long Bay Catchment Management Plan, prepared by Maunsell/Aecom, August 2006.